

# SEATING

PRICE LIST

NeutralPosture

2020  
April



---

## TABLE OF CONTENTS

---

<b>CHAIR USES MATRIX</b> .....	<b>2</b>
<b>N-TUNE SEATING SYSTEM</b> .....	<b>4</b>
<b>GUARDIAN</b> .....	<b>5</b>
<b>CONNEXION ARM</b> .....	<b>5</b>

---

<b>SELLING POLICY</b> .....	<b>6</b>
Terms & Conditions .....	6
Ordering .....	6
Prices .....	6
Taxes .....	6
Lead Time .....	6
Customer's Own Material .....	6
Storage Fee .....	6
Shipping .....	7
Freight Damage .....	7
Returns .....	7
Warranty Claims .....	7
Delay/Force Majeure .....	7
Compliance with Law .....	7

---

<b>QUICK SHIP PROGRAM</b> .....	<b>8</b>
Overview .....	8
Fabrics .....	8

---

<b>WARRANTY</b> .....	<b>9</b>
Lifetime Single Shift .....	9
Continuous-shift Intensive Use .....	9

---

<b>GENERAL INFORMATION</b> .....	<b>10</b>
Patent Information .....	10
Certification .....	10
Design .....	10
Women's Business Enterprise (WBE) .....	10
Woman Owned Small Business (WOSB) .....	10
Historically Underutilized Business (HUB) .....	10
BIFMA .....	10
SCS Indoor Advantage .....	10
Custom Logos .....	10
Cleanroom to Class 100 .....	10
Commitment to Non-obsolescence .....	10
CAL133 .....	11
ESD Seating .....	11
ESD Order Form .....	12
COM Form .....	13
GSA Contract Overview .....	14
GSA Contract Details .....	15

---

<b>HIGH PERFORMANCE SEATING</b> .....	<b>16</b>
Headrest Options .....	18
Back Options .....	18
Seat Options .....	18
Mechanism Options .....	19
Arm Options .....	19
1000 Series .....	20
5000 Series .....	22
6000 Series .....	24
8000 Series .....	26
8000 Series – Tall & Skinny .....	28
Big & Tall .....	30
XSM – Extra Small .....	32

---

<b>TASK/CONFERENCE SEATING</b> .....	<b>34</b>
Arm Options .....	36
Chair Mechanism Options .....	38
Stool Mechanism Options .....	39
Headrest Options .....	40
Connexion Arm .....	41
Balance .....	42
Cozi .....	44
Cozi Stool .....	46
Cozi 24/7 .....	48
Cozi Guest .....	50
E-Series .....	52
Embrace .....	54
Embrace Guest .....	56
Icon .....	58
Knomi .....	60
Knomi Mesh/Mesh .....	62
NV .....	64
Renati .....	66
Right Chair .....	68
Right Chair Stool .....	70
Right Chair Mesh .....	72
Right Chair Mesh Stool .....	74
Right Chair Guest .....	76
U4ia .....	78
U4ia Stool .....	80
U4ia Guest .....	82
Ulius .....	84
Ulius Stool .....	86
Ulius Guest .....	88

---

<b>ACTIVE/GUEST SEATING</b> .....	<b>90</b>
Dice .....	92
Facet .....	94

---

<b>INDUSTRIAL/HEALTHCARE SEATING</b> .....	<b>96</b>
AbChair .....	98
Adapta Stool .....	100
Geo .....	102
Graphite .....	104
Stratus Upholstered .....	106
Stratus Urethane .....	108

---

<b>STOOL OPTIONS</b> .....	<b>110</b>
NeXtep .....	110
N-position .....	110
Footrings .....	111
Footrests .....	111

---

<b>WORKPLACE ACCESSORIES</b> .....	<b>112</b>
Keyboard Arms .....	114
Keyboard Trays .....	114
Easy Combos .....	115
Monitor Arms .....	116
Forearm Supports .....	117
Anti-fatigue Floor Mats .....	117
CPU Holders .....	117
Adjustable Height Tables .....	117

---

<b>SIT/STAND</b> .....	<b>118</b>
StandUp .....	118
StandUp A1 .....	118
StandUp X1 .....	119

---

















<b>UPHOLSTERY</b> .....	<b>120</b>
Fabrics .....	120
CAL133 .....	120
ESD .....	120
Leathers .....	121
Quick Ship .....	121

---

<b>GRADED IN FABRICS</b> .....	<b>122</b>
Arc Com .....	122
Carnegie .....	123
C.F. Stinson .....	124
Designtex .....	126
Guilford of Maine .....	127
Luna .....	127
Luum .....	128
Maharam .....	128
Mayer .....	129
Momentum .....	130
Paul Brayton .....	132
Ultrafabrics® .....	132
CTL Leather .....	132



















---

# Chair Uses Matrix

			Quick Ship	High Performance	Work/Task	Executive	Conference/ Training Room	Guest	Stools
		<b>1000 Series</b> page 20	QS	✓	✓	✓			✓
		<b>5000 Series</b> page 22	QS	✓	✓				✓
		<b>6000 Series</b> page 24	QS	✓	✓	✓			
		<b>8000 Series</b> page 26	QS	✓	✓	✓			✓
		<b>Balance™</b> page 42			✓	✓	✓		
		<b>Big &amp; Tall</b> page 30	QS	✓	✓	✓			
			QS		✓		✓	✓	✓
			QS		✓		✓	✓	✓
		<b>Dice™</b> page 92						✓	
		<b>E-Series™</b> page 52	QS		✓	✓	✓		✓

✓ Standard

# Chair Uses Matrix

High Performance	Work/Task	Executive	Conference/ Training Room	Guest	Stools	Quick Ship				
		✓	✓	✓			Embrace™ page 54			
				✓		QS	Facet page 94			
	✓	✓	✓		✓	QS	Icon™ page 58			
	✓	✓	✓			QS	Knomi® page 60			
		✓	✓				NV™ page 64			
	✓	✓	✓		✓	QS	Renati™ page 66			
	✓	✓	✓	✓	✓	QS	Right Chair® page 68			
	✓	✓	✓	✓	✓	QS	U4ia® page 78			
	✓	✓	✓	✓	✓	QS	Ulius® page 84			
✓	✓	✓			✓	QS	XSM™ page 32			

✓ Standard

## START OF A REVOLUTION

N·tune®, developed by Certified Professional Ergonomists, is all about raising desk heights from 29" to 40" and then raising the chair to stool height, allowing users to easily transition between sitting and standing throughout the workday. Not only does this help alleviate the pains of a sedentary workday, the overall health benefits it provides are immense as well.

By standing for just 2 hours more than normal throughout an average workday, you can burn an extra 280 calories, translating into improvements in BMI, cholesterol, blood pressure levels and many other positive health outcomes.

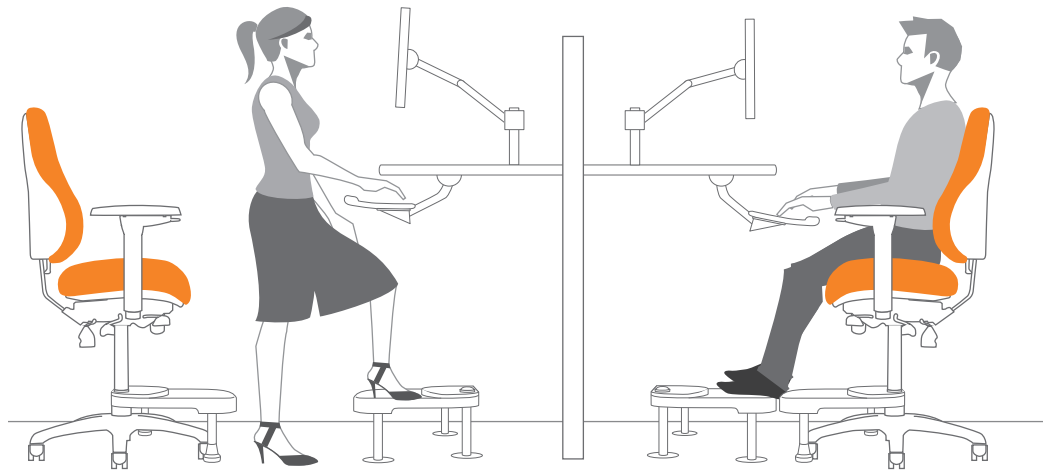

### GOOD

- U4ia® with up to 13 adjustable features
- Single platform, depth adjustable 10" NeXtep®
- N-position™ with 10" platform
- N-position™ supports up to 400 lbs

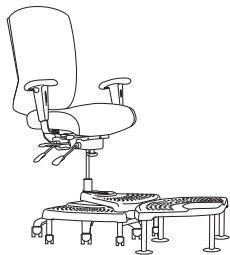

### BETTER

- Cozi® with up to 13 adjustable features
- Dual platform, depth adjustable 8"/10" NeXtep® combo
- N-position™ with 10" platform
- N-position™ supports up to 400 lbs

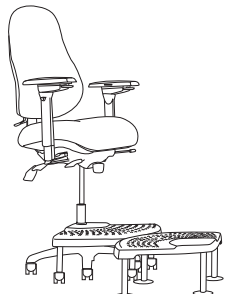

### BEST

- 8000 Series with up to 15 adjustable features
- Wide single platform 10" NeXtep® provides more surface area
- N-position™ with 10" platform
- N-position™ supports up to 400 lbs



## BULLET RESISTANT

The Guardian® is a NIJ Level II compliant bullet resistant vest custom fitted over the chair's back. A NIJ Level II compliant bullet resistant vest will provide protection against regular powered 9mm handguns, up to .357 Magnums. The vest fits over the back of the Cozi chair

and is easily removable. With the vest on the chair, it can also be used as a shield by kneeling behind the back of the chair. In a situation where response time can save your life, there is no quicker solution to protection than having the Guardian® at your desk.

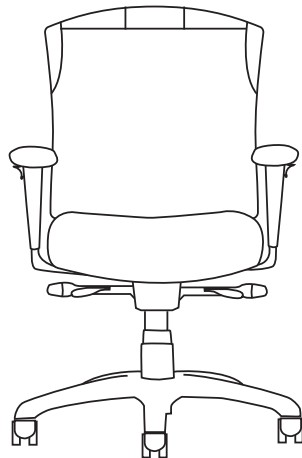

NIJ Level II compliant



Best of NeoCon gold award winner



Protection against regular powered 9mm handguns, up to .357 Magnums



Inconspicuous— looks like a regular chair



Use as shield or vest



### AVAILABLE MODELS

Cozi .....	page 44
Cozi Stool .....	page 46
Cozi 24/7 .....	page 48

## CONNEXION® ARM

### FEATURES

- Quickly and easily position your tablet where it's comfortable for you
- Holds your tablet so you don't have to
- Eliminates awkward postures and helps reduce upper body fatigue
- Engineered for ease of use
- Can be used while sitting or standing
- 3 mounting options, left, right or both

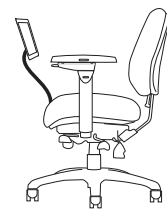

---

## TERMS AND CONDITIONS

---

For all non-rated or new accounts, payment terms are Cash in Advance (C.I.A.) until credit has been approved or rated. Please send full credit information and references and allow time for Credit Department approval.

For all established accounts, payment is due within thirty (30) days from the invoice date. Neutral Posture (NP) reserves the right to change or cancel the terms of sale based on volume, credit rating and/or credit information. Prepayment, whole or in part, may be requested at any time at the discretion of the corporate office.

Past due accounts are subject to a 1.5% late charge or maximum amount permitted under local law, for each thirty (30) days the outstanding balance remains open after the due date.

Withholding of payments based on carrier damages, shortages or other disputes is illegal and subject to charges.

### ORDERING

All orders must be in writing; faxed, e-mailed or mailed. The product model number(s) contained in the order acknowledgment shall be the final expression of the order. A purchase order is not binding on NP until customer has received NP's order confirmation or acknowledgment. Orders must have a contact name and phone number. Orders may not be cancelled without written consent of Neutral Posture.

To expedite complete/correct entry of your order, be certain all model numbers, quantities, colors and area identifications are completely specified. Also, include complete purchase order number(s), bill-to and ship-to addresses, a contact name and specific shipping dates required.

Orders should be sent to:  
Neutral Posture  
3904 N Texas Avenue Bryan, TX 77803  
979.778.0502 (Option 2)  
800.446.3746  
979.778.0408 FAX  
E-mail: [orderentry@neutralposture.com](mailto:orderentry@neutralposture.com)

When an order is received, it is assigned a scheduled ship date. That date is shown on the customer's acknowledgment.

Purchase orders may not be changed or cancelled, in whole or in part, without prior written consent of NP. Changes may affect delivery dates. Expenses incurred because of changes shall be charged to customer. In the event of cancellations, customer will be liable for reasonable cancellation charges established by NP. Orders for special product, orders including customer's own material (COM) and orders pursuant to expedited delivery programs, may not be cancelled.

A minimum of 3% of net expedite fee will be charged for orders requiring less than standard lead times.

### PRICES

Prices are subject to change without notice. List prices shall be those in effect on the date of receipt of purchase order unless shipment is requested more than ninety (90) days after order entry in which case prices in effect on the date of shipment apply. Prices in effect at time of shipment prevails in the event of a discrepancy.

### TAXES

All sales, use, excise and other taxes applicable to the sale of the products shall be paid by customer. If customer claims an exemption from any tax, customer shall submit to NP the appropriate exemption certificates.

### LEAD TIME

Quick Ship lead time is five (5) business days for products noted with Quick Ship in the price list for quantities of 25 chairs or less. 5 day Quick Ship must be requested on purchase order and is not guaranteed until acknowledged by corporate office. Lead times can vary due to fluctuation in production capacity. It is always best to confirm lead time with Customer Service. Standard lead time is 3 - 4 weeks for orders that are not Quick Ship and/or Quick Ship quantities of 26 - 300 units. For larger orders contact Customer Service for lead time.

A minimum 3% of net expedite fee will be charged for orders requiring less than standard lead times. Less than standard lead time is clarified as less than 5 business days for Quick Ship models/quantities or less than 3 - 4 weeks on non-Quick Ship models. Customer to contact Customer Service prior to submitting the order to confirm expediting is available for their specific order.

### CUSTOMER'S OWN MATERIAL

A customer who requests a fabric or other surface material not standard to NP's line of products (COM), must submit samples of the requested material to NP prior to entry of a customer order. NP will determine if the material is suitable to its manufacturing processes and products. The customer shall identify the COM to meet any applicable requirements of Underwriters Laboratories, CAL 117-2013, and/or Canadian Standards Association. If the COM is acceptable, NP will then establish a price for using the COM. For a description of the procedures for submitting samples and testing, contact Customer Service. NP shall have no responsibility for the appearance, condition, performance, durability, colorfastness or any other physical attribute of the COM. Customer shall indemnify and hold NP harmless for any damages, injuries or losses arising out of or related to use of the COM on the product.

### STORAGE FEE

Any changes made by the customer to postpone the delivery date on orders which have already gone into production, will be charged a storage fee. This fee will be applied to both partially and fully built orders. NP will advise of fee prior to applying charge.



---

## TERMS AND CONDITIONS

---

### SHIPPING

Most NP products include shipping. All standard discount orders are F.O.B destination delivered by way of parcel or freight carrier service dock to dock within the forty-eight (48) contiguous United States, and the District of Columbia. NP will designate the shipping mode and carrier based on geographical location and best service as defined by our Logistics Department.

For orders shipping outside the forty-eight (48) contiguous United States, and the District of Columbia, customer pays shipping from port of embarkation to destination and order will be shipped "best way". Customer will incur additional charges if they choose to specify a freight carrier.

Any order requiring special delivery service, other than normal dock to dock delivery, will incur additional charges. These services include, but are not limited to residential delivery, limited access delivery, lift gate service, inside delivery, call before delivery, re-routed deliveries, specific delivery date/time requests or congestion fees. These charges will be quoted at customer request.

Conditions beyond the control of NP, including weather, available facilities and traffic conditions, may affect exact time of delivery. NP shall not be responsible for specific carrier delivery date or time unless it has made a specific delivery commitment, in writing.

Delivery date and time are at the discretion of the carrier within reasonable transit time unless special arrangements have been agreed to in writing between customer and NP prior to shipment.

### Accessorial Charges (Net)

Delivery Appointment Required  
Inside Delivery/Pick Up  
Items Over 96 Inches  
Lift Gate Required  
Limited Access Delivery  
Notification/CBD  
Residential Delivery  
Ship Fully Assembled  
Pre-delivery Notification  
Re-delivery/Return Trip

Contact Customer Service at  
customerservice@neutralposture.com  
or 979.778.0502 for pricing.

### DELAY/FORCE MAJEURE

Neutral Posture shall not be liable for failure to perform or for delay in performance due to fire, flood, strike or other labor difficulty, act of God, act of any governmental authority or of the customer, riot, embargo, fuel or energy shortage, wrecks or delay in transportation, inability to obtain necessary labor, materials or manufacturing facilities from usual sources or failure of suppliers to meet their contractual obligations, or due to any cause beyond its reasonable control. If any such event occurs, Neutral Posture may extend delivery dates by a period of time necessary to overcome the effect of such delay, allocate available product or cancel any purchase order.

### FREIGHT DAMAGE

Upon receipt of shipment consignee is responsible for checking delivery for shortages or signs of damage. If a problem is discovered, bring it to the driver's attention immediately. If any of the goods called for on the Bill of Lading are shorted or damaged, consignees should not accept them until the carrier makes a notation on the freight bill of the shorted or damaged goods. The more precise the notation, the easier the claim can be resolved. NP's responsibility ceases when the consignee signs the freight delivery receipt as received in good condition. Shipping claims must be made within thirty (30) days of shipment delivery.

### RETURNS

The return of product without written authorization by NP shall not be accepted. All merchandise returns must be pre-approved by the corporate office and sent freight prepaid. Contact the Warranty Department, warrantyrequest@neutralposture.com, to receive a Return Merchandise Authorization (RMA) number for any return. RMAs are valid for thirty (30) days and any returned merchandise without a RMA number will be refused.

No deductions from any NP invoices can be made for return merchandise until it is approved by the corporate office. No deductions will be honored until returned goods are processed through our Quality Control Audit.

All returns for canceled orders must be pre-approved by the corporate office and sent freight prepaid. No returns will be authorized unless our inventory allows it, the parts are in good reusable condition and it was sold within the last thirty (30) days. Authorized seating returns will be charged a thirty percent (30%) (twenty percent (20%) for GSA) restocking fee, by agreement, to cover handling, inspection, stocking and repackaging. Authorized systems returns are subject to a forty-five percent (45%) of list restocking charge. Products not currently offered for sale by NP (including COM) shall not be authorized for return. All returned products must be unused, in original condition and in the original NP packing cartons. No refund or credit will be given for damaged products.

### WARRANTY CLAIMS

Neutral Posture reserves the right to specify that items or parts claimed to be defective, be returned to the factory for our inspection. If the claim is justified, repair or replacement of defective parts under warranty will be made through NP at no cost to the customer. NP will, at its discretion, reimburse the furniture dealer for labor (actual costs only) on warranty parts. The furniture dealer must submit a quote to be approved prior to service. If approved, the furniture dealer must then submit an invoice to NP for reimbursement after the service is completed. Freight for products and parts covered under warranty will be covered for the forty-eight (48) contiguous states, and the District of Columbia, with the method of shipping at NP's discretion. All claims must include the product serial number. NP will have no warranty obligation if the product was subjected to abuse, alteration, misuse, negligence or accident or if the user fails to perform the proper maintenance for the product.

warrantyrequest@neutralposture.com

---

**QUICK SHIP OVERVIEW**

---

Neutral Posture's Quick Ship program allows customers to receive selected items sooner, for no extra charge. Items available on the Quick Ship program will be manufactured and shipped within 5 business days of an accurately specified order. Orders must be designated as Quick Ship on the PO in order to be processed as Quick Ship.

<b>AVAILABLE CHAIRS</b>	<b>MAX QTY</b>
1000 Series .....	25
5000 Series .....	25
6000 Series .....	25
8000 Series .....	25
Big & Tall .....	25
Cozi .....	25
Cozi 24/7 .....	25
E-Series .....	25
Icon .....	25
Knomi .....	25
Renati .....	25
Right Chair .....	25
U4ia .....	25
Ulius .....	25
XSM .....	25

---

**QUICK SHIP FABRICS**

---

**Grade 1**

Ranchero	Black	230609
Spacer	Pewter	200651
Spacer	Ink	200649
Spacer	Black	200648
Spacer	Wine	200650

**Grade 2**

Ace	Toast	200714
Ace	Peony	200710
Ace	Char	200703
Ace	Midnight	200709
Ace	Jet	200707

**Grade 3**

Cloud 9	Red Dawn
Cloud 9	Midnight Sky
Cloud 9	New Haze
Cloud 9	Fog
Cloud 9	Thunder
Revive	Ebony
Revive	Goose
Revive	Ink
Revive	Metal

## WARRANTY

### EFFECTIVE APRIL 2017

Neutral Posture warrants to the original customer from the date of purchase that the products NP manufactures and sells to the customer are free of defects in workmanship and materials under normal use during the applicable warranty period set forth below.

Normal use is defined as wear which occurs in an office environment during the course of a normal single-shift usage workday (8 hours per day/5 days per week). NP products used in an environment exceeding 8 hours per day/5 days per week, are warranted to be free from defects in workmanship and materials for a period of two (2) years.

NP's warranty obligation is limited to the replacement or repair, at NP's discretion, of defective products which have been reported by the original customer to be defective in workmanship or material and which are found to be so by NP upon inspection. Defective products shall be returned at the discretion of the corporate office and all returns must be authorized in advance. NP will assume no responsibility for any labor charges.

Freight for products and parts under warranty will be covered for the forty-eight (48) contiguous United States, and the District of Columbia with the method of shipping at NP's discretion.

The user shall be responsible for all maintenance service, which includes but not limited to: lubricating and cleaning of the product, assembly, adjustment, checking all screws every six months and performing operation checks.

### PRODUCT AND PERIOD OF WARRANTY

#### 12 Years

All products and components except as noted below

#### 10 Years

Chair controls, pneumatic cylinders, casters, glides, arms and plastic components

#### 5 Years

StandUp®, StandUp®A1, inflatable lumbar, anti-fatigue mats, footrings, footrests, NeXtep®, CPU holders, monitor arms, keyboard trays, keyboard mechanisms, Connexion Arm®, foam, mesh material, Guardian®

#### 3 Years

Upholstery excluding leather, Ultraleather™, NovaSuede®, UltraSuede®, Finesse®, Graded In, COM or COL

#### 2 Years

StandUp®X1, tablet holder, forearm supports

### Replacement Parts

Warranted for two (2) years or the balance of the original warranty, whichever is longer

### Engineer-to-Order Product

NP warrants all Engineer-to-Order products to be free from defects in workmanship given normal use and care for three (3) years of single-shift service

### EXCLUSIONS

- The product was not purchased new from NP
- The product was subjected to abuse, alteration, misuse, negligence or accident
- Damage caused by a carrier
- Normal wear and tear or acts or omissions of parties other than NP (including user modification, improper use or installation of products)
- Colorfastness, matching of color, fabric puddling, or wearing qualities of any material
- Neutral Posture is not responsible for slight differences in fabric color due to supplier dye lot differences on large orders or on repeat orders placed at later dates from the original order
- Leather, Ultraleather™, NovaSuede®, UltraSuede®, Finesse®, COM, COL or any other third party materials applied to product as specified by the customer including attributes such as appearance, durability, quality, behavior, colorfastness, performance, etc.
- Non-compliance with installation and maintenance instructions
- Modifications or attachments to the product that are not approved by NP and product failures resulting from such modifications or attachments
- Damage caused by cleaning chemicals
- Dye transfers caused by external contaminants (including clothing and accessory dye such as those used on denim jeans)
- Substitution of any unauthorized non-NP components for use in the place of NP components
- Products that are exposed to extreme environmental conditions and/or have been subject to improper storage
- Damage from sharp objects such as writing utensils, heeled shoes, scissors, jewelry or keys

The warranty printed above is the only warranty applicable to these products. All other warranties expressed or limited, including but not limited to the implied warranties of merchantability and fitness for a particular purpose are disclaimed.

### 24/7 CONTINUOUS-SHIFT

Covers all components of the chair for a period of five (5) years to the original customer from the date of purchase except for upholstery and inflatable lumbar. Only upholstery with a double rub rating of over 1M is warranted for the complete 5-year period.



### Availability:

Big & Tall Series	Included in Price
Cozi 24/7	Included in Price
NP Series	\$290 List Up Charge Per Chair
All other chairs	Contact Customer Service, customerservice@neutralposture.com

Always confirm pricing/availability with Customer Service.

## GENERAL INFORMATION

### PATENT INFORMATION

Neutral Posture® Chair	U.S. Patent #4,552,404
AbStool®	U.S. Patent #6,877,812
360° Adjustable Arms	U.S. Patent #7,104,606
Adjustment Guide	U.S. Patent #6,296,312
Balance™	U.S. Patent #D458,777
Connexion® Arm	U.S. Patent #D541,061
ElementAl®	U.S. Patent #8,955,905
Fring® Footrest	U.S. Patent #D588,145
Inflatable Lumbar	U.S. Patent #6,142,571
Keyboard Tray	U.S. Patent #6,607,246
NeXtep®	U.S. Patent #6,220,663
N•Position™	U.S. Patent #6,290,295
StandUp®	U.S. Patent #D463,441
Cover for a Seating Device	U.S. Patent #7,036,886
Other Patents Pending	U.S. Patent #D557,513
	U.S. Patent #7,048,236
	U.S. Patent #D647,353

### CERTIFICATION

Independent tests show that all NP chairs meet or exceed current ANSI/HFES 100-2007, ANSI/BIFMA and California 117 certification standards. Certain NP products meet California Technical Bulletin 133 and task intensive certification standards. All cylinders are rated Class 4 or better by UNI standards.

### DESIGN

NP reserves the right to make changes and improvements in design and materials and to discontinue parts and components at their discretion.

### WOMEN'S BUSINESS ENTERPRISE (WBE)

This certification is administered by the Women's Business Enterprise National Council (WBENC) and is used to qualify potential vendors as credible diversity suppliers. NP is certified as a WBE by WBENC.

### WOMAN OWNED SMALL BUSINESS (WOSB)

The U.S. Small Business Administration's WOSB Federal Contract Program provides greater access to federal contracting opportunities for WOSBs. The program allows contracting officers to set aside specific contracts for certified WOSBs and helps federal agencies achieve the existing statutory goal of five percent of federal contracting dollars being awarded to WOSBs. NP is certified as a WOSB by WBENC.

### HISTORICALLY UNDERUTILIZED BUSINESS (HUB)

The Texas Historically Underutilized Business (HUB) program encourages the use of HUBs in state procurement and provides information to minority and woman-owned businesses on the state's procurement process. NP is certified as a HUB.

### BUSINESS AND INSTITUTIONAL FURNITURE

#### MANUFACTURER'S ASSOCIATION

NP is a member of the Business and Institutional Furniture Manufacturer's Association (BIFMA). Tests developed by BIFMA and approved by the American National Standards Institute (ANSI) determine the strength and durability of office furniture in its everyday use. Although this testing does not serve as a warranty or guarantee, NP standard products within this price list meet or exceed applicable ANSI/BIFMA X5.1-2011, BIFMA G1-2001 and ANSI/HFES 100-2007 standards. Combinations of options added on to the standard products may not meet ANSI/ BIFMA standards. Those combinations which do not meet ANSI/BIFMA standards are not available on GSA. Additionally, most seating is BIFMA level 2 certified. For more information, contact Customer Service at [customerservice@neutralposture.com](mailto:customerservice@neutralposture.com).

#### SCS INDOOR ADVANTAGE CERTIFICATION

All NP seating products are certified by SCS Global Services for indoor air quality.

#### CUSTOM LOGOS

Your company, university, mascot, etc as a custom logo in embroidery can be placed on most fabrics or in Cloud 9™. Contact Customer Service at [customerservice@neutralposture.com](mailto:customerservice@neutralposture.com) for details and cost.

#### CLEANROOM TO CLASS 100

Independent testing according to Federal STD 209E (correlates to ISO-14644C Class 5) confirms NP Cleanroom seating meets or exceeds Class 100 requirements. NP Cleanroom models are designed to prevent particulates in Cleanroom environments. In addition to top-quality vinyl upholstery, a HEPA filtration system in the seat and backrest prevent particulate release.

#### Available Models

Available Models	Upcharge (List)
Big & Tall	\$120
Cozi	\$120
Cozi 24/7	\$120
NP55500-D1	\$120
NP55600-D1	\$120
AbChair (Urethane)	\$120
Adapta Stool	\$120
Stratus Upholstered	\$120
Stratus Urethane	\$70
Graphite	\$70
Geo	\$70

#### NEUTRAL POSTURE'S COMMITMENT TO NON-OBSOLESCENCE.

To address the way people work today and the ever changing work environment, Neutral Posture introduces new and improved products. These introductions are designed to retrofit existing customer inventory. Enhancements mean nothing if you can't adapt. If a product is enhanced, function changes or demand becomes low, Neutral Posture will provide compatible products across generations of equal or similar appearance and operational characteristics in terms of form, fit and function. Because mills and suppliers discontinue fabrics, laminates and paints with little or no notice, Neutral Posture is not able to guarantee finish availability. When possible notification of discontinued finishes to dealers and end users will be made. Neutral Posture will provide a 90-day window from the date of discontinuation in which we will guarantee availability of the finish.

## GENERAL INFORMATION

### CAL 133

Almost every model in the NP family of seating products meets the specifications for California Technical Bulletin 117, the industry standard for upholstered furniture. Additionally, NP chairs can be upgraded to meet the more stringent, California Technical Bulletin 133 standard, which is required by the California Bureau of Home Furnishings and Thermal Insulation for contract seating used in public facilities.

#### Standard CAL 133 Models and Options

Fabric/Vinyl \$265 Upcharge (List)  
 Leather Contact  
 customerservice@neutralposture.com

Available Chairs	Options	Exceptions
5000 Series	All	Inflatable Lumbar
6000 Series	All	Inflatable Lumbar No Pillow Top All Headrests
8000 Series	All	Inflatable Lumbar All Headrests
Big & Tall	All	Inflatable Lumbar Arm Shroud Pillow Top All Headrests
AbChair	All	Urethane AbRest Cleanroom
Cozi	All	
Cozi 24/7	All	
Dice	All	Arms
Right Chair	All	
U4ia	All	

NP can also utilize COM for the CAL 133 upgrade if the material is an inherently flame retardant (FR) material, like Trevira® or Avora®. For large orders and corporate standards programs, NP can also facilitate a lab-supervised burn test for each chair/upholstery combination. These tests will be negotiated and supervised through NP's Engineering Department.

All models that comply with CAL 133 will be labeled accordingly on both the packing slip and the serial number description tag. Additionally, they will contain a label with the following notice:

Notice: This chair is manufactured in compliance with California Technical Bulletin 133 and meets the flammability requirements of the California Bureau of Home Furnishings.

### WARNING

This product can expose you to chemicals including (Antimony Oxide), which is known to the State of California to cause cancer. For more information, go to [www.P65Warnings.ca.gov/furniture](http://www.P65Warnings.ca.gov/furniture).

### ELECTROSTATIC DISCHARGE (ESD) SEATING

NP ESD models are tested to meet the requirements of today's ESD environment with conductive components and fabrics (1% carbon fiber with surface resistivity no greater than 1.3 x 10<sup>6</sup> ohms/sq.cm when test in accordance with ANSI/ESD STM12.1-2013). ESD chairs are an integral part of an effective ESD system that includes a conductive floor or mat to complete conductive path.

#### Upholstery

- Conductive cloth or vinyl

#### Options

- 20" Footring
- Upholstered Back Outer
- 4" Height Adjustable Arms
- T Arms
- Drag Chain

#### Features

- Polished Aluminum Base

#### Available Chairs

Available Chairs	Upcharge (List)
5000 Series	\$290
6000 Series	\$290
8000 Series	\$290
AbChair	\$290
Adapta	\$290
Big & Tall	\$290
Cozi	\$290
Cozi Stool	\$290
Cozi 24/7	\$290
Stratus Upholstered	\$290
XSM – Extra Small	\$290

Upcharge added to graded price. Many other options and features available at an added charge. Please refer to page 12 for pricing.

# ESD Order Form

Client \_\_\_\_\_

Contact Name \_\_\_\_\_

Phone Number \_\_\_\_\_

Fax Number \_\_\_\_\_

Email Address \_\_\_\_\_

City \_\_\_\_\_

State \_\_\_\_\_ Zip \_\_\_\_\_

Purchase Order Number \_\_\_\_\_

Quantity \_\_\_\_\_

Model # \_\_\_\_\_ List Price \_\_\_\_\_

Send completed form with order to:

Neutral Posture, Inc.  
3904 N. Texas Avenue  
Bryan, TX 77803  
979.778.0502 (Option 2)  
800.446.3746  
979.778.0408 FAX  
orderentry@neutralposture.com

## Available Chairs

- 5000 Series
- 6000 Series
- 8000 Series
- AbChair
- Adapta
- Big & Tall (*Arms are fixed*)
- Cozi
- Cozi Stool
- Cozi 24/7
- Icon
- Stratus Upholstered
- XSM – Extra Small

## ESD Option – Per Chair

## Upcharge

### Standard ESD Package (E)

**\$290**

- Convert to equivalent ESD cylinder
- Convert to aluminum base
- Convert to equivalent ESD casters or glides
- The standard ESD chair is without arms
- ESD wiring & braiding
- Ships fully assembled

### Select Additional ESD Options

- |   |       |
|---|-------|
| <input type="checkbox"/> Add conductivity to Upholstered Back Outer (U)<br><i>Only available on Neutral Posture® Series</i> | \$20  |
| <input type="checkbox"/> 4" Adjustable Arms with conductivity   | \$240 |
| <input type="checkbox"/> Add conductivity to 20" Chrome Footring (R2)   | \$20  |
| <input type="checkbox"/> Drag chain<br><i>Includes chain and conductivity</i>   | \$30  |

Total ESD up charge per chair \$ \_\_\_\_\_



# Customer's Own Material (COM) Form

Dealer Name \_\_\_\_\_

Contact Name \_\_\_\_\_

Address \_\_\_\_\_

City \_\_\_\_\_ State \_\_\_\_\_ Zip \_\_\_\_\_

Phone Number \_\_\_\_\_

Fax Number \_\_\_\_\_

Email Address \_\_\_\_\_

Client Name \_\_\_\_\_

Fabric Source (Mill) \_\_\_\_\_

Fabric Pattern Name \_\_\_\_\_

Fabric Pattern Number \_\_\_\_\_

Fabric Color \_\_\_\_\_

Backer Type (if any) \_\_\_\_\_

## Fabric Orientation

Attach a fabric sample with the correct orientation

TOP

BOTTOM

Send completed form and sample yardage to:

Neutral Posture, Inc.  
Attention: Customer Service  
3904 N. Texas Avenue  
Bryan, Texas 77803  
(979) 778-0502 or  
customerservice@neutralposture.com

We will make sure material is sent to the correct plant(s) for testing.

Preferred memo sample size is 12" x 12". Additional yardage may be required for testing.

Please make sure fabric has been approved for CAL117 flammability testing. Most industry fabrics have been tested and approved. NP may not use a fabric that has not been approved for CAL117.

NP will notify you of test results.

Contact COM Department for pricing/grading. COM yardage may vary, depending on repeat pattern. COM not covered under warranty.

All COM subject to NP testing and approval.

COM form must accompany fabric.

If fabric is a stripe please select the correct orientation:

Horizontal       Vertical

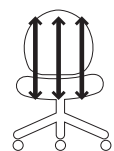

Is there a desired top?

Yes \_\_\_\_\_ No \_\_\_\_\_

If so please specify.

# GSA Contract Overview

## GSA CONTRACT

We have had a contract with GSA for over 20 years and they continue to be our most favored customer.

NP is dedicated to helping government agencies meet their facilities and acquisition needs. NP is registered with the System For Award Management (SAM) formerly Central Contractor Registry (CCR) with ORCA certifications, has an assigned cage code of 0UTL8 and is eligible to receive federal contract awards. NP is also recognized as a Woman Owned Small Disadvantaged Business by the U.S. Small Business Administration (SBA).

## WOMEN-OWNED SMALL BUSINESS (WOSB) / ECONOMICALLY DISADVANTAGED WOMEN- OWNED SMALL BUSINESS (EDWOSB)

The U. S. Small Business Administration (SBA) issued the Final Rule to amend its regulations governing small business contracting procedures. The SBA has increased the emphasis and awareness of contracting mandates regarding the new 5% spend mandate for WOSB/EDWOSB's similar to those in place for 8a, SDV and HUB Zone businesses.

The SBA has also implemented a Sole Source vehicle for Economically Disadvantaged Women-Owned Small Businesses (EDWOSB). Neutral Posture, a small business manufacturer, received this certification in April of 2016.

Our Packaged Office contract includes many great manufacturing partners and we are willing to team with other manufacturers to support strong GSA Dealers and meet the needs of our customers.

For more information please visit  
[NeutralPosture.com/WOSB](http://NeutralPosture.com/WOSB)

## GSA OVERVIEW

GSA Contract# GS-27F-0014Y

Schedule MAS – Furniture

SIN 337121H	Household, Dormitory & Quarters Furniture
SIN 337127	Institutional Furniture
SIN 33721	Office Furniture
SIN 33721P	Packaged Office Furniture
SIN OLM	Order Level Materials

## NAICS CODES

337127	Institutional Furniture Manufacturing
337211	Wood Office Furniture Manufacturing
337214	Office Furniture (except wood) Manufacturing
423210	Furniture Merchant Wholesalers

NP products may be found on GSA Advantage.

## AVAILABLE ON GSA

Products available on GSA as of March 2021. For the most current list of products available on GSA contact Customer Service or visit [NeutralPosture.com](http://NeutralPosture.com).

### SEATING

1000 Series  
5000 Series  
6000 Series  
8000 Series  
Adapta  
Big & Tall  
Balance  
Cozi  
Cozi 24/7  
Cozi Guest  
Dice  
E-Series  
Embrace  
Embrace Guest  
Equity<sup>NP</sup>  
Facet  
Geo  
Graphite  
Icon  
Knomi  
NV  
Renati  
Right Chair  
Right Chair Guest  
U4ia  
U4ia Guest  
Ulius  
Ulius Guest  
XSM – Extra Small

### WORKPLACE ACCESSORIES

Anti-fatigue Mats  
Boost Monitor Arm  
CPU Holders  
Forearm Supports  
Freedom Arm  
Sit/Stand Monitor Arm  
StandUp  
StandUp A1  
StandUp X1 – SUPX136BL  
StandUp X1 – SUPX136WL  
StandUp X1 – SUPX140BL  
StandUp X1 – SUPX140WL  
StandUp X1 – SUPX142BL  
StandUp X1 – SUPX148BL  
StandUp X1 – SUPX1CR36BL  
StandUp X1 – SUPX1CR42BL  
Tablet Holder

## NOT AVAILABLE ON GSA

Products not available on GSA as of March 2021.

### SEATING

AbChair  
Guardian  
NBF074  
NBF075  
P Arm  
TheraGel Memory Foam

### WORKPLACE ACCESSORIES

Ascension Arm  
SofTouch Keyboard Tray  
StandUp X1 – SUPX136B  
StandUp X1 – SUPX136W  
StandUp X1 – SUPX142B  
StandUp X1 – SUPX1CR42B

**TERM DATE 6/26/2012 – 6/26/2022**

- 1a. Special Item Numbers Awarded**
  - SIN 337121H Household, Dormitory & Quarters Furniture
  - SIN 337127 Institutional Furniture
  - SIN 33721 Office Furniture
  - SIN 33721P Packaged Office Furniture
  - SIN OLM Order Level Materials
- 1b. Lowest Priced Item**
  - SIN 337121H Contact Corporate Office
  - SIN 337127 Contact Corporate Office
  - SIN 33721 SPTRY Pencil Tray ..... \$5.95
  - SIN 33721P Contact Corporate Office
- 1c. Installation Rate — SIN 33721**
  - \$51.50 per hour (non-union inclusive IFF)
  - \$106.25 per hour (union inclusive of IFF)
- 2. Maximum Order**
  - SIN 337121H ..... \$1,000,000
  - SIN 337127 ..... \$250,000
  - SIN 33721 ..... \$250,000
  - SIN 33721P ..... \$5,000,000
  - SIN OLM ..... \$0
- 3. Minimum Order**
  - All SINS ..... \$50
- 4. Geographic Coverage**
  - CONUS & OCONUS
- 5. Point of Production**
  - 3904 N. Texas Avenue, Bryan, Brazos County, Texas, USA
- 6. Discount from List Price**
  - Seating/Workplace Accessories**
  - SIN 33721 — Discount 58%
  - Systems**
  - SIN 33721 — Discount 70%
- 7. Quantity Discounts**
  - No discount tiers have been negotiated.
- 8. Prompt Payment Terms**
  - Net 30 Days
- 9. Government Purchase Cards Accepted**
  - Visa/Master Card
- 10. Foreign Item**
  - None
- 10a. Time of Delivery**
  - 5 – 90 days after receipt of order
- 10b. Expedited Delivery**
  - Expedited delivery available. Contact NP Customer Service.
- 10c. Overnight and 2-day Delivery**
  - Available with an upcharge. Contact NP Customer Service.
- 12. F.O.B. Points**
  - Destination/CONUS, within the 48 contiguous states and the District of Columbia. Port of embarkation for delivery to Alaska, Hawaii, Puerto Rico, the Virgin Islands and U.S. Government installations overseas.
- 13. Ordering Address**
  - Neutral Posture, Inc.
  - attn: Order Entry/ \* or dealer
  - 3904 N. Texas Avenue
  - Bryan, TX 77803
  - 979.778.0502
  - 800.446.3746
  - fax 979.778.0408
  - orderentry@neutralposture.com
  - \* Authorized Dealers should be cited on order
- 14. Payment Address**
  - Neutral Posture, Inc.
  - 3904 N. Texas Avenue
  - Bryan, TX 77803
- 15. Warranty Provision**
  - Neutral Posture’s commercial warranty applies.
- 16. Export Packing Charges**
  - Contact NP Customer Service for quote.
- 17. Terms and Conditions of Government Purchase Card**
  - Government purchase cards will be accepted for purchases at prices shown in this authorized price list (no additional discount offered).
- 18. Terms and Conditions Of Rental, Maintenance, and Repair**
  - Not applicable
- 19. Terms and Conditions of Installation**
  - Installation and instruction are available from authorized dealers. Please contact your local NP Dealer for pricing.
- 20. Terms and Conditions of Repair Parts**
  - Repair parts are offered at the agreed upon discount from the NP repair parts price list in effect at the time the repair parts are ordered.
- 20a. Terms and Conditions for Any Other Services**
  - GSA has accepted all of our standard terms and conditions as noted on page 6–7.
- 21. List of Service and Distribution Points**
  - Not applicable
- 22. List of Dealers**
  - Please contact NP, or visit NeutralPosture.com for the name of your nearest authorized Dealer.
- 23. Preventive Maintenance**
  - Not offered or applicable
- 24. Environmental Attributes**
  - Not applicable
- 25. Other Information**
  - Tax Identification Number (TIN): 74-2983577
  - DUNS: 61-0339723
  - Cage Code: OUTL8
  - NAICS: 337214
- 26. SAM**
  - NP is registered in System For Award Management (SAM).
  - NOTE:** It is mandatory that all Government purchase orders be made out to NP only. Local Dealers are not authorized to accept purchase orders, issue invoices or receive payment of Government funds for these items without serious violation of this Federal Supply Schedule Contract.

---

## HIGH PERFORMANCE SEATING

---

Neutral Posture's high performance chairs are truly at the top of the line in the industry when it comes to comfort. The chairs offer up to 15 adjustments ensuring that the chair will fit every inch of your body just right. Our high performance chairs are made to fit anyone and everyone, with our Neutral Posture Series chairs fitting anyone within the 5<sup>th</sup> percentile female to the 95<sup>th</sup> percentile male and the XSM and the Big and Tall fitting anyone outside that

range. These chairs are also well known for their weight dispersing abilities. Weight dispersion presents a much more comfortable seat by spreading out the weight of your body, lowering the pressure by 50%. The high performance seating is engineered as a tool to empower those who use it. The high performance seating can be used for long periods of time promoting productivity and are just as comfy at the end of the day as they were at the beginning.

# HIGH PERFORMANCE SEATING

---

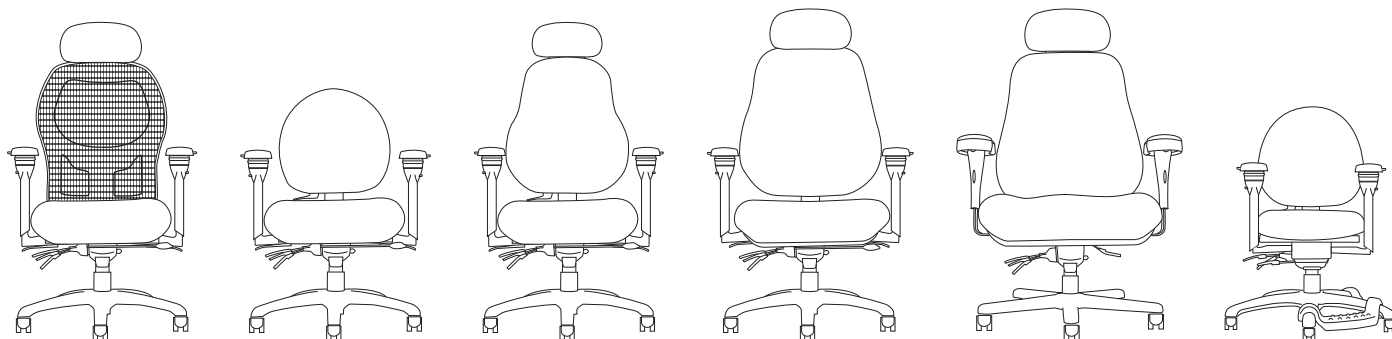

## HEADREST OPTIONS

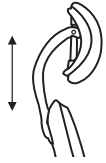

### HE HEADREST

Black Vinyl

- For mesh back*
- Height

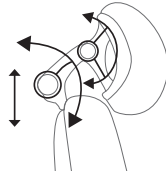

### H4 DUAL PIVOT

Matching Upholstery

- Height
- Depth
- 2 Pivot Points

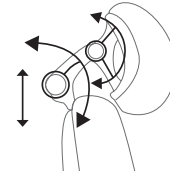

### H5 DUAL PIVOT

Black Faux Leather

- Height
- Depth
- 2 Pivot Points

## BACK OPTIONS



### 1 BACK

- Not height adjustable
- Mesh back
- Independent lumbar adjustment
- Easily converts to an upholstered back with optional sleeve



### 5 BACK

- Height adjustable
- Mid back with minimal lateral contour
- Excellent lower back support with inflatable lumbar
- Small profile
- Good choice for tight areas



### 6 BACK

- Height adjustable
- High back with minimal lateral contour
- Excellent upper & lower back support with inflatable lumbar
- Tallest, widest backrest
- Good choice for larger users



### 8 BACK

- Height adjustable
- High back with moderate lateral contour
- Excellent upper & lower back support with inflatable lumbar
- Excellent choice for all applications

## SEAT OPTIONS



### 5 SEAT

Medium Seat, Minimal Contour

- 3" thick foam eliminates "bottoming out"
- Fits widest range of population



### 8 SEAT

Large Seat, Minimal Contour

- Large dimension accommodates larger users
- 3" thick foam eliminates "bottoming out"



### 6 SEAT

Medium Seat, Moderate Contour

- Contoured seat design minimizes seated pressure
- 3" thick foam eliminates "bottoming out"
- Arm post notches reduce armrest width by 2"



### 9 SEAT

Large Seat, Deep Contour

- Largest contoured seat
- Designed for larger users & to support forward tilt (i.e. neutral posture)
- Maximizes surface contact to disperse seated pressure



### 7 SEAT

Medium Seat, Deep Contour

- Most contoured seat design
- Designed to support forward tilt (i.e. neutral posture)
- Maximizes surface contact to disperse seated pressure



## CHAIR MECHANISM

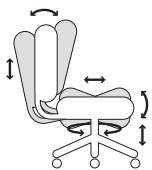

### 0 MULTI-FUNCTION

- Center pivot
- Swivel 360°
- Pneumatic seat height
- Back height  
*(not available on 1000 Series)*
- Seat angle
- Seat tension
- Independent back angle
- Forward tilt-stop
- Seat slider

## ARM OPTIONS

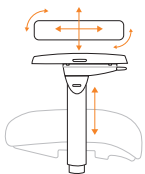

### 0 ARM 5-way 360°

- Height, width, depth & pivot adjustable
- 24 positive-lock angle positions in 360° range
- Arm pads slide in & out for additional width adjustment
- Arm pads slide back & forth allowing closest access to work

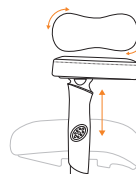

### 6 ARM Oversized Black Vinyl Arm Pads

- Height, width & pivot adjustable
- Oversized, padded arm pads provide large, extra soft surface
- 22 positive-lock angle positions in 360° range
- 180° rotation alternates long/short end positioning for access to work

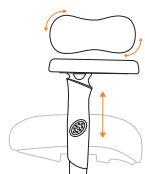

### 3 ARM 360° Swivel w/Oversized Urethane

- Height, width & pivot adjustable
- Oversized arm pads provide large, soft surface
- 22 positive-lock angle positions in 360° range
- 180° rotation alternates long/short end positioning for access to work

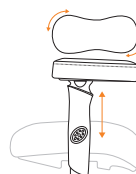

### 7 ARM Oversized Fabric/Leather Arm Pads

- Height, width & pivot adjustable
- Oversized, padded arm pads provide large, extra soft surface
- 22 positive-lock angle positions in 360° range
- 180° rotation alternates long/short end positioning for access to work

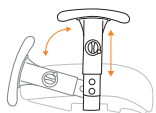

### 4 ARM Swing

- Unique design swings arm down & out of the way
- Height, width & swing-down adjustable
- Excellent for multi-user applications where not all want armrests



### P ARM 360° Swivel

- Height, width & pivot adjustable
- 22 positive-lock angle positions in 360° range
- 180° rotation alternates long/short end positioning for access to work

# 1000 Series

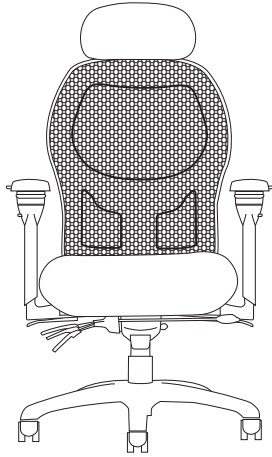

NPS1500-H5

### Features

- Up to 14 active adjustments
- Mesh back
- Independent lumbar
- Generous foam for optimal comfort
- Convert mesh back to upholstered w/optional sleeve
- 2 headrest options

### Standard Features

- 5-way 360° Arms
- Carpet Casters
- 26" Black Base
- 5" Cylinder
- Seat Slider

### Need it Now? 5-day Quick Ship

Only standard features are available as Quick Ship unless otherwise noted.

#### QUICK SHIP ARMS

- 0 5-way 360°
- 5 No Arms

#### QUICK SHIP FABRICS

For available quick ship fabrics see page 8.

## Step 1 — Model Number

Series Code	Back	Select a Seat	Select an Arm	Mech
<b>NPS</b> Neutral Posture Series	<b>1</b> Mesh Back	<b>5</b> Medium Seat, Minimal Contour <b>6</b> Medium Seat, Moderate Contour <b>7</b> Medium Seat, Deep Contour <b>8</b> Large Seat, Minimal Contour	<b>0</b> 5-way 360° \$0 <b>3</b> 360° w/Oversized Urethane \$75 <b>4</b> Swing \$155 <b>5</b> No Arms (\$140) <b>6</b> 360° w/Oversized Black Vinyl \$225 <b>7</b> 360° w/Oversized Fabric/Leather \$265 <b>P</b> 360° Swivel \$0	<b>0</b> Multi-function \$0 
<b>NPS</b>	<b>1</b>	<b>5</b>	<b>0</b>	<b>0</b>



NPS1500	NPS1600	NPS1700	NPS1800
\$1,238	\$1,305	\$1,316	\$1,316
\$1,298	\$1,365	\$1,376	\$1,376
\$1,358	\$1,425	\$1,436	\$1,436
\$1,428	\$1,495	\$1,506	\$1,506
\$1,498	\$1,565	\$1,576	\$1,576
\$1,578	\$1,645	\$1,656	\$1,656
\$1,658	\$1,725	\$1,736	\$1,736
\$1,748	\$1,815	\$1,826	\$1,826
\$1,838	\$1,905	\$1,916	\$1,916

40 x 26 x 26	40 x 26 x 26	40 x 26 x 26	40 x 26 x 26
56 lbs	56 lbs	61 lbs	61 lbs
21	23	23	23
17.5 – 22.5	17.5 – 22.5	17.5 – 22.5	18.25 – 23.25
15.5 – 18	16 – 18.5	16 – 18.5	18 – 20.5
F3° – R11°	F9° – R6°	F10° – R3°	F5° – R7°
19	19	19	19
21	21	21	21
95° – 114°	100° – 126°	103° – 123°	102° – 109°
3	3	3	3
7 – 11	7 – 11	7 – 11	6.5 – 10.5
15.75 – 22.25	15.75 – 22.25	18 – 22.25	18 – 22.25
26	26	26	26
1 yd	1 yd	1 yd	1 yd
28 x 26 x 24	28 x 26 x 24	28 x 26 x 24	28 x 26 x 24
66 lbs	66 lbs	71 lbs	71 lbs
KD	KD	KD	KD

All measurements are nominal and shown in inches. Specs may differ for stools.

- Grade 1
- Grade 2
- Grade 3
- Grade 4
- Grade 5
- Grade 6
- Grade 7
- Grade 8
- Grade 9

- Chair (H x W x D)
- Chair Weight
- Seat Width
- Seat Height
- Seat Depth
- Seat Angle
- Back Width
- Back Height
- Back Angle
- Lumbar Range
- Arm Height
- Arm Width
- Base Diameter
- COM Yardage
- Shipping Box (L x W x H)
- Shipping Weight
- Shipping Method

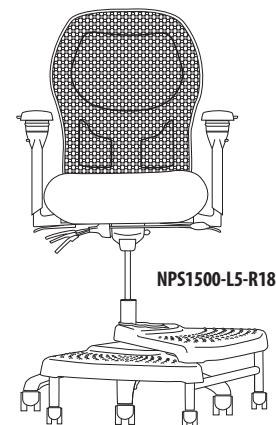

NPS1500-L5-R18

## Step 2 — Add option codes after model number NPS1500 - \_ - \_

### General

<b>CR</b>	Cleanroom to Class 100	\$120
<b>CX</b>	Coccyx Cutout <i>Cloud 9, Revive, Top Shelf &amp; M Plus</i>	\$215
<b>F</b>	Fring® Footrest <i>Only available on (B0) base</i>	\$50
<b>N</b>	N-dulgent® Memory Foam	\$75
<b>N2</b>	ThermaGel Memory Foam	\$150

### Back Sleeve – Back of sleeve made w/Spacer

<b>S1</b>	Grade 1	\$110
<b>S2</b>	Grade 2	\$160
<b>S3</b>	Grade 3	\$200
<b>S4</b>	Grade 4	\$240
<b>S5</b>	Grade 5	\$280
<b>S6</b>	Grade 6	\$330
<b>S7</b>	Grade 7	\$380
<b>S8</b>	Grade 8	\$430
<b>S9</b>	Grade 9	\$480

### Casters/Glides

<b>C1</b>	Hard Floor	\$25
<b>C2</b>	Glides	\$25
<b>C3</b>	Occupied Braking	\$185
<b>C4</b>	Unoccupied Braking	\$60
<b>C8</b>	Chrome Carpet	\$90
<b>C9</b>	Chrome Hard Floor	\$100

### Bases

<b>B6</b>	26" Polished Aluminum <i>Recommended with (L1)</i>	\$140
<b>B8</b>	27" Brushed Aluminum <i>Recommended with (L1)</i>	\$140
<b>B12</b>	28" Black	\$110

### Continuous Shift Warranty

<b>IU</b>	Continuous-shift warranty	\$290
-----------	---------------------------	-------

### Chair Cylinders

<b>L1</b>	3" Cylinder	\$0
<b>L13</b>	7" Dual Stage	\$55
<b>L14</b>	10" Dual Stage	\$55

### Headrests

<b>HE</b>	Height Adjustable <i>Black vinyl</i>	\$60
<b>H5</b>	Dual Pivot <i>Black faux leather</i>	\$280

### Connexion® Arm

<b>Z1</b>	Connexion Arm <i>Only available on (5) &amp; (6) seat</i>	\$350
-----------	--	-------

### Connexion® Arm Attachments

<b>A1</b>	Tablet Holder <i>Requires (Z1) Connexion Arm</i>	\$149
-----------	---	-------

## Stool Options

### Stool Cylinders

<b>L4</b>	8" Cylinder	\$55
<b>L5</b>	10" Cylinder	\$55
<b>L7</b>	7" Cylinder	\$55

### Footrings – for stool cylinders only

<b>R1</b>	18" Black Plastic	\$60
<b>R2</b>	20" Chrome	\$80

### NeXtep® – for stool cylinders only

<b>R8</b>	8" w/Casters	\$185
<b>R10</b>	10" w/Casters	\$185
<b>R18</b>	8"/10" w/Casters	\$295
<b>RW8</b>	Wide 8" w/Casters	\$295
<b>RW10</b>	Wide 10" w/Casters	\$295

Also available w/glides.

For additional stool options see page 110.

## 5000 Series

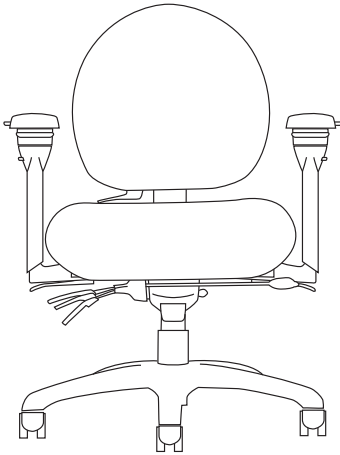

NPS5500

## Features

- Up to 12 active adjustments
- Mid back & contoured seat designs
- Passive weight dispersion design
- Generous foam for optimal comfort
- Inflatable lumbar

## Standard Features

- 5-way 360° Arms
- Carpet Casters
- 26" Black Base
- 5" Cylinder
- Seat Slider

## Need it Now? 5-day Quick Ship

Only standard features are available as Quick Ship unless otherwise noted.

## QUICK SHIP ARMS

- 0 5-way 360°
- 5 No Arms

## QUICK SHIP FABRICS

For available Quick Ship fabrics see page 8.

## Step 1 — Model Number

Series Code	Back	Select a Seat	Select an Arm	Mech
<b>NPS</b> Neutral Posture Series	<b>5</b> Mid Back	<b>5</b> Medium Seat, Minimal Contour <b>6</b> Medium Seat, Moderate Contour <b>7</b> Medium Seat, Deep Contour <b>8</b> Large Seat, Minimal Contour <b>9</b> Large Seat, Deep Contour	<b>0</b> 5-way 360° \$0 <b>3</b> 360° w/Oversized Urethane \$75 <b>4</b> Swing \$155 <b>5</b> No Arms (\$140) <b>6</b> 360° w/Oversized Black Vinyl \$225 <b>7</b> 360° w/Oversized Fabric/Leather \$265 <b>P</b> 360° Swivel \$0	<b>0</b> Multi-function \$0 
<b>NPS</b>	<b>5</b>	<b>5</b>	<b>0</b>	<b>0</b>

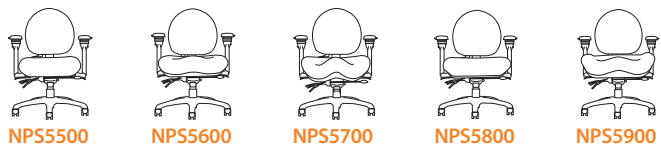

NPS5500	NPS5600	NPS5700	NPS5800	NPS5900
\$1,284	\$1,352	\$1,362	\$1,362	\$1,399
\$1,344	\$1,412	\$1,422	\$1,422	\$1,459
\$1,404	\$1,472	\$1,482	\$1,482	\$1,519
\$1,474	\$1,542	\$1,552	\$1,552	\$1,589
\$1,544	\$1,612	\$1,622	\$1,622	\$1,659
\$1,624	\$1,692	\$1,702	\$1,702	\$1,739
\$1,704	\$1,772	\$1,782	\$1,782	\$1,819
\$1,794	\$1,862	\$1,872	\$1,872	\$1,909
\$1,884	\$1,952	\$1,962	\$1,962	\$1,999

36 x 26 x 26	36 x 26 x 26	36 x 26 x 26	36 x 26 x 26	36 x 26 x 26
52.5 lbs	52.5 lbs	57 lbs	57 lbs	57 lbs
21	23	23	23	25
17.5 – 22.5	17.5 – 22.5	17.5 – 22.5	18.25 – 23.5	17.5 – 22.5
15.5 – 18	16 – 18.5	16 – 18.5	18 – 20.5	19 – 21.5
F3° – R11°	F9° – R6°	F10° – R3°	F5° – R7°	F8° – R6°
17.5	17.5	17.5	17.5	17.5
17 – 21	17 – 21	16 – 20	17 – 21	16 – 20
102° – 122°	107° – 122°	107° – 124°	108° – 128°	102° – 118°
4	4	4	4	4
7 – 11	7 – 11	7 – 11	6.5 – 10.5	6.5 – 10.5
15.75 – 22.25	15.75 – 22.25	18 – 22.25	18 – 22.25	18.5 – 22.25
26	26	26	26	26
2 yd	2 yd	2 yd	2 yd	2 yd
28 x 26 x 24	28 x 26 x 24	28 x 26 x 24	28 x 26 x 24	28 x 26 x 24
62.5 lbs	62.5 lbs	67 lbs	67 lbs	67 lbs
KD	KD	KD	KD	FA

All measurements are nominal and shown in inches. Specs may differ for stools.

- Grade 1
- Grade 2
- Grade 3
- Grade 4
- Grade 5
- Grade 6
- Grade 7
- Grade 8
- Grade 9

- Chair (H x W x D)
- Chair Weight
- Seat Width
- Seat Height
- Seat Depth
- Seat Angle
- Back Width
- Back Height
- Back Angle
- Lumbar Range
- Arm Height
- Arm Width
- Base Diameter
- COM Yardage
- Shipping Box (L x W x H)
- Shipping Weight
- Shipping Method

Upholstered Back Outer		
U1	Grade 1	\$120
U2	Grade 2	\$140
U3	Grade 3	\$160
U4	Grade 4	\$180
U5	Grade 5	\$200
U6	Grade 6	\$220
U7	Grade 7	\$240
U8	Grade 8	\$260
U9	Grade 9	\$280

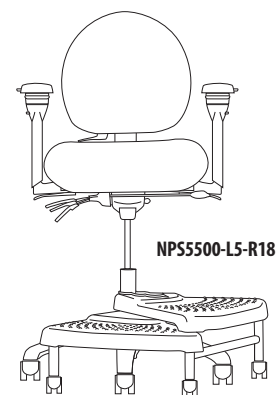

## Step 2 — Add option codes after model number NPS5500 - \_\_ - \_\_

Continuous Shift Warranty		Casters/Glides	
<b>IU</b>	Continuous-shift warranty	<b>C1</b>	Hard Floor
	\$290	<b>C2</b>	Glides
<b>General</b>		<b>C3</b>	Occupied Braking
<b>A</b>	Thoracic Support	<b>C4</b>	Unoccupied Braking
	\$80	<b>C8</b>	Chrome Carpet
<b>CR</b>	Cleanroom to Class 100	<b>C9</b>	Chrome Hard Floor
	\$120		\$100
<b>CX</b>	Coccyx Cutout	<b>Bases</b>	
	\$215	<b>B6</b>	26" Polished Aluminum
	<i>Cloud 9, Revive, Top Shelf &amp; M Plus</i>		\$140
<b>D1</b>	No Inflatable Lumbar	<b>B8</b>	27" Brushed Aluminum
	(\$50)		\$140
<b>E</b>	ESD*		<i>Recommended with (L1)</i>
	\$290	<b>B12</b>	28" Black
<b>F</b>	Fring® Footrest		\$110
	\$50		<i>Recommended with (L1)</i>
<b>N</b>	N-dulgent® Memory Foam		
	\$125		
<b>N2</b>	ThermaGel Memory Foam		
	\$150		

Chair Cylinders	
<b>L1</b>	3" Cylinder
	\$0
<b>L13</b>	7" Dual Stage
	\$55
<b>L14</b>	10" Dual Stage
	\$55
Connexion® Arm	
<b>Z1</b>	Connexion Arm
	\$350
	<i>Only available on (5) &amp; (6) seat</i>
Connexion® Arm Attachments	
<b>A1</b>	Tablet Holder
	\$149
	<i>Requires (Z1) Connexion Arm</i>

## Stool Options

Stool Cylinders	
<b>L4</b>	8" Cylinder
	\$55
<b>L5</b>	10" Cylinder
	\$55
<b>L7</b>	7" Cylinder
	\$55
Footrings for stool cylinders only	
<b>R1</b>	18" Black Plastic
	\$60
<b>R2</b>	20" Chrome
	\$80
NeXtep® for stool cylinders only	
<b>R8</b>	8" w/Casters
	\$185
<b>R10</b>	10" w/Casters
	\$185
<b>R18</b>	8"/10" w/Casters
	\$295
<b>RW8</b>	Wide 8" w/Casters
	\$295
<b>RW10</b>	Wide 10" w/Casters
	\$295

Also available w/glides.

For additional stool options see page 110.

\* Contact Customer Service – customerservice@neutralposture.com

# 6000 Series

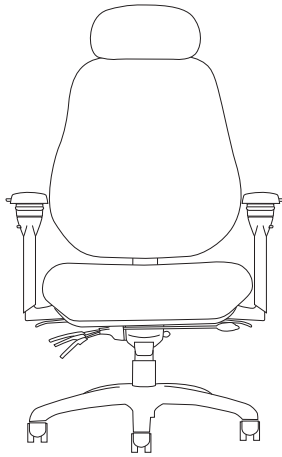

NPS6800-H4

### Features

- Up to 15 active adjustments
- High back & contoured seat designs
- Passive weight dispersion design
- Generous foam for optimal comfort
- Inflatable lumbar
- Optional headrest

### Standard Features

- 5-way 360° Arms
- Carpet Casters
- 26" Black Base
- 5" Cylinder
- Seat Slider

### Need it Now? 5-day Quick Ship

Only standard features are available as Quick Ship unless otherwise noted.

#### QUICK SHIP ARMS

- 0 5-way 360°
- 5 No Arms

#### QUICK SHIP FABRICS

For available Quick Ship fabrics see page 8.

## Step 1 — Model Number

Series Code	Back	Select a Seat	Select an Arm	Mech
<b>NPS</b> Neutral Posture Series	<b>6</b> High Back	<b>5</b> Medium Seat, Minimal Contour <b>6</b> Medium Seat, Moderate Contour <b>7</b> Medium Seat, Deep Contour <b>8</b> Large Seat, Minimal Contour <b>9</b> Large Seat, Deep Contour	<b>0</b> 5-way 360° \$0 <b>3</b> 360° w/Oversized Urethane \$75 <b>4</b> Swing \$155 <b>5</b> No Arms (\$140) <b>6</b> 360° w/Oversized Black Vinyl \$225 <b>7</b> 360° w/Oversized Fabric/Leather \$265 <b>P</b> 360° Swivel \$0	<b>0</b> Multi-function \$0 
<b>NPS</b>	<b>6</b>	<b>8</b>	<b>0</b>	<b>0</b>





NPS6500	NPS6600	NPS6700	NPS6800	NPS6900
\$1,472	\$1,539	\$1,550	\$1,550	\$1,586
\$1,532	\$1,599	\$1,610	\$1,610	\$1,646
\$1,592	\$1,659	\$1,670	\$1,670	\$1,706
\$1,662	\$1,729	\$1,740	\$1,740	\$1,776
\$1,732	\$1,799	\$1,810	\$1,810	\$1,846
\$1,812	\$1,879	\$1,890	\$1,890	\$1,926
\$1,892	\$1,959	\$1,970	\$1,970	\$2,006
\$1,982	\$2,049	\$2,060	\$2,060	\$2,096
\$2,072	\$2,139	\$2,150	\$2,150	\$2,186

42 x 26 x 26	42 x 26 x 26	42 x 26 x 26	42 x 26 x 26	42 x 26 x 26
63 lbs	63 lbs	67.5 lbs	67.5 lbs	67.5 lbs
21	23	23	23	25
17.5 – 22.5	17.5 – 22.5	17.5 – 22.5	18.25 – 23.25	17.5 – 22.5
15 – 17.5	15 – 17.5	16 – 18.5	18 – 20.5	19.5 – 22
F3° – R11°	F9° – R6°	F10° – R3°	F5° – R7°	F8° – R6°
22.5	22.5	22.5	22.5	22.5
21.5 – 25.5	21.5 – 25.5	22 – 26	22.5 – 26.5	22 – 26
97° – 112°	98° – 113°	97° – 113°	99° – 114°	99° – 115°
4	4	4	4	4
7 – 11	7 – 11	7 – 11	6.5 – 10.5	6.5 – 10.5
15.75 – 22.25	15.75 – 22.25	18 – 22.25	18 – 22.25	18.5 – 22.25
26	26	26	26	26
2.5 yd	2.5 yd	2.5 yd	2.5 yd	2.5 yd
28 x 26 x 24	28 x 26 x 24	28 x 26 x 24	28 x 26 x 24	37 x 30 x 52
73 lbs	73 lbs	77.5 lbs	77.5 lbs	77.5 lbs
KD	KD	KD	KD	FA

- Grade 1
- Grade 2
- Grade 3
- Grade 4
- Grade 5
- Grade 6
- Grade 7
- Grade 8
- Grade 9

Upholstered Back Outer		
U1	Grade 1	\$120
U2	Grade 2	\$140
U3	Grade 3	\$160
U4	Grade 4	\$180
U5	Grade 5	\$200
U6	Grade 6	\$220
U7	Grade 7	\$240
U8	Grade 8	\$260
U9	Grade 9	\$280

- Chair (H x W x D)
- Chair Weight
- Seat Width
- Seat Height
- Seat Depth
- Seat Angle
- Back Width
- Back Height
- Back Angle
- Lumbar Range
- Arm Height
- Arm Width
- Base Diameter
- COM Yardage
- Shipping Box (L x W x H)
- Shipping Weight
- Shipping Method

All measurements are nominal and shown in inches.

## Step 2 — Add option codes after model number NPS6800 - \_ - \_

<b>Continuous Shift Warranty</b>	<b>Finishes</b>	<b>Casters/Glides</b>	<b>Cylinders</b>
<b>IU</b> Continuous-shift warranty \$290	<b>PT</b> Pillow Top \$860 <i>Only available on (8) seat; Only in Canter, Ultraleather™ or leather</i>	<b>C1</b> Hard Floor \$25	<b>L1</b> 3" Cylinder \$0
<b>General</b>	<b>SL</b> Stitched Leather \$350 <i>Not available on (7) &amp; (9) seat; Only in Ultraleather™ or leather</i>	<b>C2</b> Glides \$25	<b>L13</b> 7" Dual Stage \$55
<b>A</b> Thoracic Support \$80		<b>C3</b> Occupied Braking \$185	<b>L14</b> 10" Dual Stage \$55
<b>CR</b> Cleanroom to Class 100 \$120		<b>C4</b> Unoccupied Braking \$60	<b>Headrest</b>
<b>CX</b> Coccyx Cutout \$215 <i>Cloud 9, Revive, Top Shelf &amp; M Plus</i>		<b>C8</b> Chrome Carpet \$90	<b>H4</b> Dual Pivot \$280 <i>Matching upholstery</i>
<b>E</b> ESD* \$290		<b>C9</b> Chrome Hard Floor \$100	<b>Connexion® Arm</b>
<b>F</b> Fring® Footrest \$50 <i>Only available on (B0) base</i>		<b>Bases</b>	<b>Z1</b> Connexion Arm \$350 <i>Only available on (5) &amp; (6) seat</i>
<b>N</b> N-dulgent® Memory Foam \$125		<b>B6</b> 26" Polished Aluminum \$140 <i>Recommended with (L1)</i>	<b>Connexion® Arm Attachments</b>
<b>N2</b> ThermoGel Memory Foam \$150		<b>B8</b> 27" Brushed Aluminum \$140 <i>Recommended with (L1)</i>	<b>A1</b> Tablet Holder \$149 <i>Requires (Z1) Connexion Arm</i>
		<b>B12</b> 28" Black \$110	

\* Contact Customer Service – customerservice@neutralposture.com

## 8000 Series

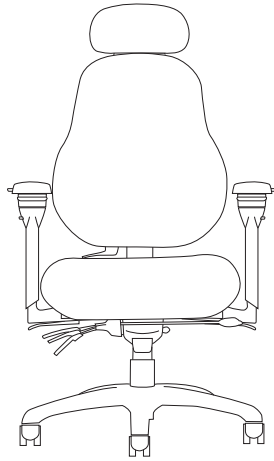

NPS8500-H4

## Features

- Up to 15 active adjustments
- High back & contoured seat designs
- Passive weight dispersion design
- Generous foam for optimal comfort
- Inflatable lumbar
- Optional headrest

## Standard Features

- 5-way 360° Arms
- Carpet Casters
- 26" Black Base
- 5" Cylinder
- Seat Slider

## Need it Now? 5-day Quick Ship

Only standard features are available as Quick Ship unless otherwise noted.

## QUICK SHIP ARMS

- 0 5-way 360°
- 5 No Arms

## QUICK SHIP FABRICS

For available Quick Ship fabrics see page 8.

## Step 1 — Model Number

Series Code	Back	Select a Seat	Select an Arm	Mech
<b>NPS</b> Neutral Posture Series	<b>8</b> High Back	<b>5</b> Medium Seat, Minimal Contour <b>6</b> Medium Seat, Moderate Contour <b>7</b> Medium Seat, Deep Contour <b>8</b> Large Seat, Minimal Contour <b>9</b> Large Seat, Deep Contour	<b>0</b> 5-way 360° \$0 <b>3</b> 360° w/Oversized Urethane \$75 <b>4</b> Swing \$155 <b>5</b> No Arms (\$140) <b>6</b> 360° w/Oversized Black Vinyl \$225 <b>7</b> 360° w/Oversized Fabric/Leather \$265 <b>P</b> 360° Swivel \$0	<b>0</b> Multi-function \$0 
<b>NPS</b>	<b>8</b>	<b>5</b>	<b>0</b>	<b>0</b>

Extra Tall

NPS8500	NPS8600	NPS8700	NPS8800	NPS8900
\$1,420	\$1,487	\$1,498	\$1,498	\$1,534
\$1,480	\$1,547	\$1,558	\$1,558	\$1,594
\$1,540	\$1,607	\$1,618	\$1,618	\$1,654
\$1,610	\$1,677	\$1,688	\$1,688	\$1,724
\$1,680	\$1,747	\$1,758	\$1,758	\$1,794
\$1,760	\$1,827	\$1,838	\$1,838	\$1,874
\$1,840	\$1,907	\$1,918	\$1,918	\$1,954
\$1,930	\$1,997	\$2,008	\$2,008	\$2,044
\$2,020	\$2,087	\$2,098	\$2,098	\$2,134

40 x 26 x 26	40 x 26 x 26	40 x 26 x 26	40 x 26 x 26	40 x 26 x 26
59.5 lbs	61 lbs	65 lbs	65 lbs	65 lbs
21	23	23	23	25
17.5 – 22.5	17.5 – 22.5	17.5 – 22.5	18.25 – 23.25	17.5 – 22.5
15.5 – 18	16 – 18.5	16 – 18.5	18 – 20.5	19 – 21.5
F3° – R11°	F9° – R6°	F10° – R3°	F5° – R7°	F8° – R6°
19.5	19.5	19.5	19.5	19.5
21.5 – 25.5	22 – 26	22 – 26	22.5 – 26.5	22 – 26
100° – 119°	100° – 115°	100° – 115°	100° – 121°	100° – 116°
4	4	4	4	4
7 – 11	7 – 11	7 – 11	6.5 – 10.5	6.5 – 10.5
15.75 – 22.25	15.75 – 22.25	18 – 22.25	18 – 22.25	18.5 – 22.25
26	26	26	26	26
2 yd	2 yd	2 yd	2 yd	2 yd
28 x 26 x 24	28 x 26 x 24	28 x 26 x 24	28 x 26 x 24	37 x 30 x 52
69.5 lbs	71 lbs	75 lbs	75 lbs	75 lbs
KD	KD	KD	KD	FA

All measurements are nominal and shown in inches. Specs may differ for stools.

- Grade 1
- Grade 2
- Grade 3
- Grade 4
- Grade 5
- Grade 6
- Grade 7
- Grade 8
- Grade 9

- Chair (H x W x D)
- Chair Weight
- Seat Width
- Seat Height
- Seat Depth
- Seat Angle
- Back Width
- Back Height
- Back Angle
- Lumbar Range
- Arm Height
- Arm Width
- Base Diameter
- COM Yardage
- Shipping Box (L x W x H)
- Shipping Weight
- Shipping Method

Upholstered Back Outer		
U1	Grade 1	\$120
U2	Grade 2	\$140
U3	Grade 3	\$160
U4	Grade 4	\$180
U5	Grade 5	\$200
U6	Grade 6	\$220
U7	Grade 7	\$240
U8	Grade 8	\$260
U9	Grade 9	\$280

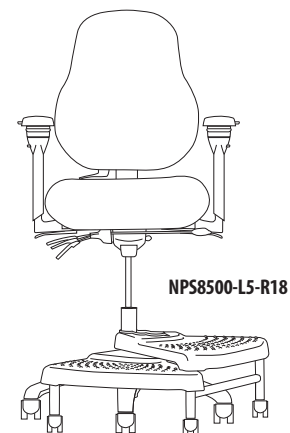

## Step 2 — Add option codes after model number NPS8500 - \_\_ - \_\_

### Continuous Shift Warranty

**IU** Continuous-shift warranty \$290

### General

**A** Thoracic Support \$80

**CR** Cleanroom to Class 100 \$120

**CX** Coccyx Cutout \$215

*Cloud 9, Revive, Top Shelf & M Plus*

**D1** No Inflatable Lumbar (\$50)

**E** ESD\* \$290

**F** Fring® Footrest \$50

*Only available on (B0) base*

**N** N-dulgent® Memory Foam \$125

**N2** ThermaGel Memory Foam \$150

### Finishes

**SL** Stitched Leather \$350

*Not available on (7) or (9) seat;  
Only in Ultraleather™ or leather*

### Casters/Glides

**C1** Hard Floor \$25

**C2** Glides \$25

**C3** Occupied Braking \$185

**C4** Unoccupied Braking \$60

**C8** Chrome Carpet \$90

**C9** Chrome Hard Floor \$100

### Bases

**B6** 26" Polished Aluminum \$140

*Recommended with (L1)*

**B8** 27" Brushed Aluminum \$140

*Recommended with (L1)*

**B12** 28" Black \$110

### Cylinders

**L1** 3" Cylinder \$0

**L13** 7" Dual Stage \$55

**L14** 10" Dual Stage \$55

### Headrest

**H4** Dual Pivot \$280

*Matching upholstery*

### Connexion® Arm

**Z1** Connexion Arm \$350

*Only available on (5) & (6) seat*

### Connexion® Arm Attachments

**A1** Tablet Holder \$149

*Requires (Z1) Connexion Arm*

## Stool Options

### Stool Cylinders

**L4** 8" Cylinder \$55

**L5** 10" Cylinder \$55

**L7** 7" Cylinder \$55

### Footrings for stool cylinders only

**R1** 18" Black Plastic \$60

**R2** 20" Chrome \$80

### NeXtep® for stool cylinders only

**R8** 8" w/Casters \$185

**R10** 10" w/Casters \$185

**R18** 8"/10" w/Casters \$295

**RW8** Wide 8" w/Casters \$295

**RW10** Wide 10" w/Casters \$295

*Also available w/glides.*

For additional stool options see page 110.

# 8000 Series

## Tall & Skinny

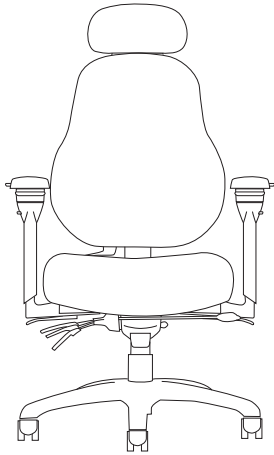

NPS8200-H4

### Features

- Up to 15 active adjustments
- High back & extra deep seat
- Passive weight dispersion design
- Generous foam for optimal comfort
- Inflatable lumbar
- Optional headrest

### Standard Features

- 5-way 360° Arms
- Carpet Casters
- 28" Intensive Use Black Base
- 5" Cylinder
- Seat Slider

## Step 1 — Model Number

Series Code	Back	Select a Seat	Select an Arm	Mech
<b>NPS</b> Neutral Posture Series	<b>8</b> High Back	<b>2</b> Extra Deep Seat <i>Minimal Contour</i>	<b>0</b> 5-way 360° \$0 <b>3</b> 360° w/Oversized Urethane \$75 <b>4</b> Swing \$155 <b>5</b> No Arms (\$140) <b>6</b> 360° w/Oversized Black Vinyl \$225 <b>7</b> 360° w/Oversized Fabric/Leather \$265 <b>P</b> 360° Swivel \$0	<b>0</b> Multi-function 
<b>NPS</b>	<b>8</b>	<b>2</b>	<b>0</b>	<b>0</b>



**NPS8200**

\$1,648	<b>Grade 1</b>
\$1,708	<b>Grade 2</b>
\$1,768	<b>Grade 3</b>
\$1,838	<b>Grade 4</b>
\$1,908	<b>Grade 5</b>
\$1,988	<b>Grade 6</b>
\$2,068	<b>Grade 7</b>
\$2,158	<b>Grade 8</b>
\$2,248	<b>Grade 9</b>

Upholstered Back Outer		
<b>U1</b>	<b>Grade 1</b>	\$120
<b>U2</b>	<b>Grade 2</b>	\$140
<b>U3</b>	<b>Grade 3</b>	\$160
<b>U4</b>	<b>Grade 4</b>	\$180
<b>U5</b>	<b>Grade 5</b>	\$200
<b>U6</b>	<b>Grade 6</b>	\$220
<b>U7</b>	<b>Grade 7</b>	\$240
<b>U8</b>	<b>Grade 8</b>	\$260
<b>U9</b>	<b>Grade 9</b>	\$280

43 x 28 x 28	Chair (H x W x D)
57 lbs	Chair Weight
20	Seat Width
18.75 – 23.75	Seat Height
20.5 – 23	Seat Depth
F7° – R8°	Seat Angle
19.5	Back Width
21.5 – 25.5	Back Height
100° – 119°	Back Angle
4	Lumbar Range
7 – 11	Arm Height
15.75 – 22.25	Arm Width
28	Base Diameter
2 yd	COM Yardage
28 x 26 x 24	Shipping Box (L x W x H)
67 lbs	Shipping Weight
KD	Shipping Method

All measurements are nominal and shown in inches.

**Step 2 — Add option codes after model number NPS8200 - \_ - \_**

General		Casters/Glides		Cylinders		Headrest					
<b>A</b>	Thoracic Support	\$80	<b>C1</b>	Hard Floor	\$25	<b>L1</b>	3" Cylinder	\$0	<b>H4</b>	Dual Pivot	\$280
<b>CR</b>	Cleanroom to Class 100	\$120	<b>C2</b>	Glides	\$25	<b>L7</b>	7" Cylinder	\$55		Matching upholstery	
<b>D1</b>	No Inflatable Lumbar	(\$50)				<b>L13</b>	7" Dual Stage	\$55			
<b>N</b>	N-dulgent® Memory Foam	\$125									
<b>N2</b>	ThermaGel Memory Foam	\$150									

# Big & Tall

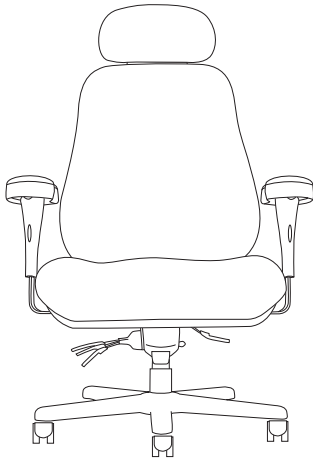

**BTC10100-H4**



**BTC16800**  
Extra Tall

## Features

- Up to 11 active adjustments
- High back & contoured seat designs
- 24/7 Continuous-shift 5-year warranty only available on upholstery with a double rub rating of over 1,000,000
- Available in both regular & junior sizes
- Supports users up to 500 lbs and/or 7 ft tall
- Inflatable lumbar
- Optional headrest
- Optional leather pillow top

## Standard Features

- Oversized Padded Arms
- Carpet Casters
- 28" Intensive Use Black Base
- 5" Cylinder
- Seat Slider

## Need it Now? 5-day Quick Ship

Only standard features are available as Quick Ship unless otherwise noted.

### QUICK SHIP ARMS

- 0 Oversized Padded
- 1 Urethane Arm Pads

### QUICK SHIP FABRICS

For available Quick Ship fabrics see page 8.

## Step 1 — Model Number

Series Code	Select a Back	Select a Seat	Select an Arm	Mech
<b>BTC</b> Big & Tall	<b>16</b> High Back <b>10</b> Extra Large Back	<b>1</b> Extra Large Seat, Minimal Contour <b>8</b> Large Seat, Minimal Contour <b>9</b> Large Seat, Deep Contour	<b>0</b> Oversized Padded \$0 <b>1</b> Urethane Arm Pads (\$50)	<b>0</b> Multi-function 
<b>BTC</b>	<b>10</b>	<b>1</b>	<b>0</b>	<b>0</b>





Regular	Junior (Extra Tall)	
<b>BTC10100</b>	<b>BTC16800</b>	<b>BTC16900</b>
\$2,236	\$2,236	\$2,272
\$2,296	\$2,296	\$2,332
\$2,356	\$2,356	\$2,392
\$2,426	\$2,426	\$2,462
\$2,496	\$2,496	\$2,532
\$2,576	\$2,576	\$2,612
\$2,656	\$2,656	\$2,692
\$2,746	\$2,746	\$2,782
\$2,836	\$2,836	\$2,872

42 x 35 x 28	41 x 31 x 28	41 x 31 x 28
85 lbs	76 lbs	76 lbs
27	23	25
20 – 25	19 – 24	19 – 24
20 – 22	19 – 21	20 – 22
F1° – R7.5°	F4° – R12°	F1° – R9°
24	22.5	22.5
22 – 26	22 – 26	24 – 28
96° – 118°	95° – 112°	97° – 115°
4	4	4
7 – 10	7 – 10	7 – 10
24	21	24
28	28	28
2.5 yd	2.5 yd	2.5 yd
37 x 30 x 52	37 x 30 x 52	37 x 30 x 52
105 lbs	96 lbs	96 lbs
FA	FA	FA

All measurements are nominal and shown in inches.

- Grade 1
- Grade 2
- Grade 3
- Grade 4
- Grade 5
- Grade 6
- Grade 7
- Grade 8
- Grade 9

- Chair (H x W x D)
- Chair Weight
- Seat Width
- Seat Height
- Seat Depth
- Seat Angle
- Back Width
- Back Height
- Back Angle
- Lumbar Range
- Arm Height
- Arm Width
- Base Diameter
- COM Yardage
- Shipping Box (L x W x H)
- Shipping Weight
- Shipping Method

Upholstered Back Outer		
<b>U1</b>	Grade 1	\$120
<b>U2</b>	Grade 2	\$140
<b>U3</b>	Grade 3	\$160
<b>U4</b>	Grade 4	\$180
<b>U5</b>	Grade 5	\$200
<b>U6</b>	Grade 6	\$220
<b>U7</b>	Grade 7	\$240
<b>U8</b>	Grade 8	\$260
<b>U9</b>	Grade 9	\$280

## Step 2 — Add option codes after model number BTC10100 - \_ - \_

General	Finishes	Bases	Headrest
<b>A Thoracic Support</b> \$80	<b>PT Pillow Top</b> \$1,000 <i>Only available on (1) &amp; (8) seat; only in Canter, Ultraleather™ or leather</i>	<b>B9 28" Chrome</b> \$160	<b>H4 Dual Pivot</b> \$280 <i>Matching upholstery</i>
<b>CR Cleanroom to Class 100</b> \$120			
<b>CX Coccyx Cutout</b> \$215 <i>Cloud 9, Revive, Top Shelf &amp; M Plus</i>			
<b>E ESD*</b> \$290 <i>Arms are fixed when ESD added</i>			
<b>J Upholstered Arm Pad</b> \$65 <i>Only available on (0) arm</i>			
<b>N N-dulgent® Memory Foam</b> \$125			
<b>N2 ThermaGel Memory Foam</b> \$150			
	<b>Casters/Glides</b>	<b>Cylinders</b>	
	<b>C1 Hard Floor</b> \$25	<b>L1 3" Cylinder</b> \$0	
	<b>C2 Glides</b> \$25		

**XSM™**  
Extra Small

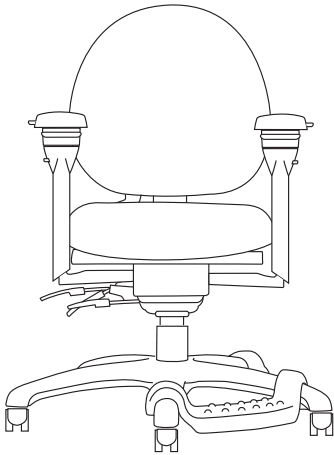

XSM5300-F

**Features**

- Up to 15 active adjustments
- Petite seat
- Mesh back, mid back or high back
- Passive weight dispersion design
- Generous foam for optimal comfort
- Inflatable lumbar on 5 & 8 back
- Optional headrest available on 1 & 8 back

**Standard Features**

- 5-way 360° Arms
- Carpet Casters
- 26" Black Base
- 5" Cylinder
- Seat Slider

**Need it Now? 5-day Quick Ship**

Only standard features are available as Quick Ship unless otherwise noted.

**QUICK SHIP ARMS**

- 0 5-way 360°
- 5 No Arms

**QUICK SHIP FABRICS**

For available Quick Ship fabrics see page 8.

**Step 1 — Model Number**

Series Code	Select a Back	Select a Seat	Select an Arm	Mech
<b>XSM</b> Extra Small Series	<ul style="list-style-type: none"> <li>1 Mesh Back</li> <li>5 Mid Back</li> <li>8 High Back</li> </ul>	<ul style="list-style-type: none"> <li>3 Petite Seat, Minimal Contour</li> </ul>	<ul style="list-style-type: none"> <li>0 5-way 360° \$0</li> <li>3 360° w/Oversized Urethane \$75</li> <li>5 No Arms (\$140)</li> <li>6 360° w/Oversized Black Vinyl \$225</li> <li>7 360° w/Oversized Fabric/Leather \$265</li> <li>P 360° Swivel \$0</li> </ul>	<ul style="list-style-type: none"> <li>0 Multi-function </li> </ul>
<b>XSM</b>	<b>5</b>	<b>3</b>	<b>0</b>	<b>0</b>



**XSM1300**



**XSM5300**



**XSM8300**

\$1,305	\$1,352	\$1,487
\$1,365	\$1,412	\$1,547
\$1,425	\$1,472	\$1,607
\$1,495	\$1,542	\$1,677
\$1,565	\$1,612	\$1,747
\$1,645	\$1,692	\$1,827
\$1,725	\$1,772	\$1,907
\$1,815	\$1,862	\$1,997
\$1,905	\$1,952	\$2,087

- Grade 1**
- Grade 2**
- Grade 3**
- Grade 4**
- Grade 5**
- Grade 6**
- Grade 7**
- Grade 8**
- Grade 9**

39.75 x 26 x 26	35.5 x 26 x 26	40.25 x 26 x 26	Chair (H x W x D)
52.5 lbs	52 lbs	54.5 lbs	Chair Weight
17	17	17	Seat Width
15.75 – 20.75	15.75 – 20.75	15.75 – 20.75	Seat Height
15.5 – 18	15.5 – 18	15.5 – 18	Seat Depth
F4° – R11°	F4° – R11°	F6° – R12°	Seat Angle
19	17.5	19.5	Back Width
23	18 – 22	23 – 27	Back Height
95° – 115°	105° – 121°	95° – 111°	Back Angle
3	4	4	Lumbar Range
7 – 11	7 – 11	7 – 11	Arm Height
13.5 – 18.25	13.5 – 18.25	13.5 – 18.25	Arm Width
26	26	26	Base Diameter
1 yd	2 yd	2 yd	COM Yardage
28 x 26 x 24	28 x 26 x 24	28 x 26 x 24	Shipping Box (L x W x H)
62.5 lbs	62 lbs	64.5 lbs	Shipping Weight
KD	KD	KD	Shipping Method

All measurements are nominal and shown in inches. Specs may differ for stools.

Upholstered Back Outer		
<b>U1</b>	<b>Grade 1</b>	<b>\$120</b>
<b>U2</b>	<b>Grade 2</b>	<b>\$140</b>
<b>U3</b>	<b>Grade 3</b>	<b>\$160</b>
<b>U4</b>	<b>Grade 4</b>	<b>\$180</b>
<b>U5</b>	<b>Grade 5</b>	<b>\$200</b>
<b>U6</b>	<b>Grade 6</b>	<b>\$220</b>
<b>U7</b>	<b>Grade 7</b>	<b>\$240</b>
<b>U8</b>	<b>Grade 8</b>	<b>\$260</b>
<b>U9</b>	<b>Grade 9</b>	<b>\$280</b>

Only available on (5) or (8) back

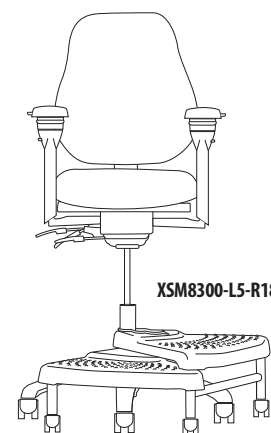

**XSM8300-L5-R18**

**Step 2 — Add option codes after model number XSM5300 - \_ - \_**

General		Back Sleeve – Back of sleeve made w/Spacer		Casters/Glides		Stool Cylinders		
<b>A</b>	<b>Thoracic Support</b> <i>Not available on (1) back</i>	<b>\$80</b>	<b>S1</b> <b>Grade 1</b>	<b>\$110</b>	<b>C1</b> <b>Hard Floor</b>	<b>\$25</b>	<b>L4</b> <b>8" Cylinder</b>	<b>\$55</b>
<b>CR</b>	<b>Cleanroom to Class 100</b>	<b>\$120</b>	<b>S2</b> <b>Grade 2</b>	<b>\$160</b>	<b>C2</b> <b>Glides</b>	<b>\$25</b>	<b>L5</b> <b>10" Cylinder</b>	<b>\$55</b>
<b>CX</b>	<b>Coccyx Cutout</b> <i>Cloud 9, Revive, Top Shelf &amp; M Plus</i>	<b>\$215</b>	<b>S3</b> <b>Grade 3</b>	<b>\$200</b>	<b>C3</b> <b>Occupied Braking</b>	<b>\$185</b>	<b>L7</b> <b>7" Cylinder</b>	<b>\$55</b>
<b>D1</b>	<b>No Inflatable Lumbar</b>	<b>(\$50)</b>	<b>S4</b> <b>Grade 4</b>	<b>\$240</b>	<b>C4</b> <b>Unoccupied Braking</b>	<b>\$60</b>	<b>Footrings – for stool cylinders only</b>	
<b>E</b>	<b>ESD*</b>	<b>\$290</b>	<b>S5</b> <b>Grade 5</b>	<b>\$280</b>	<b>C8</b> <b>Chrome Carpet</b>	<b>\$90</b>	<b>R1</b> <b>18" Black Plastic</b>	<b>\$60</b>
<b>F</b>	<b>Fring® Footrest</b> <i>Only available on (B0) base</i>	<b>\$50</b>	<b>S6</b> <b>Grade 6</b>	<b>\$330</b>	<b>C9</b> <b>Chrome Hard Floor</b>	<b>\$100</b>	<b>R2</b> <b>20" Chrome</b>	<b>\$80</b>
<b>N</b>	<b>N-dulgent® Memory Foam</b>	<b>\$125</b>	<b>S7</b> <b>Grade 7</b>	<b>\$380</b>	<b>Bases</b>		<b>NeXtep® – for stool cylinders only</b>	
<b>N2</b>	<b>ThermaGel Memory Foam</b>	<b>\$150</b>	<b>S8</b> <b>Grade 8</b>	<b>\$430</b>	<b>B6</b> <b>26" Polished Aluminum</b>	<b>\$140</b>	<b>R8</b> <b>8" w/Casters</b>	<b>\$185</b>
			<b>S9</b> <b>Grade 9</b>	<b>\$480</b>	<i>Recommended with (L1)</i>		<b>R10</b> <b>10" w/Casters</b>	<b>\$185</b>
			<b>Chair Cylinders</b>		<b>B8</b> <b>27" Brushed Aluminum</b>	<b>\$140</b>	<b>R18</b> <b>8"/10" w/Casters</b>	<b>\$295</b>
<b>Headrests</b>			<b>L1</b> <b>3" Cylinder</b>	<b>\$0</b>	<i>Recommended with (L1)</i>		<b>RW8</b> <b>Wide 8" w/Casters</b>	<b>\$295</b>
<b>HE</b>	<b>Height Adjustable</b> <i>Black vinyl – (1) back only</i>	<b>\$60</b>	<b>L13</b> <b>7" Dual Stage</b>	<b>\$55</b>	<b>B12</b> <b>28" Black</b>	<b>\$110</b>	<b>RW10</b> <b>Wide 10" w/Casters</b>	<b>\$295</b>
<b>H4</b>	<b>Dual Pivot</b> <i>Matching upholstery – (8) back only</i>	<b>\$280</b>	<b>L14</b> <b>10" Dual Stage</b>	<b>\$55</b>	<b>Also available w/glides.</b>			
<b>H5</b>	<b>Dual Pivot</b> <i>Black faux leather – (1) back only</i>	<b>\$280</b>						

For additional stool options see page 110.

\* Contact Customer Service – customerservice@neutralposture.com

---

## TASK/CONFERENCE SEATING

---

Neutral Posture's task/conference seating offers a wide range of styles, features and options to address any application needs. The task/conference seating was designed with elegance and engineered with functionality and health promoting benefits in mind. The task/conference seating is also a very broad category, providing anything from highly ergonomic chairs for personal use to stools and guest chairs for shorter periods of seated time and unique tasks. The multitude of specialty armrests and fabric types available will ensure that you have the chair needed to complete the task at hand and

look good while doing it. In our task/conference seating we have many different families of chairs, allowing you to fill your space with multi-functional chairs having a common theme and look. We offer many of our task/conference chairs in mesh making the chair more breathable for comfort, as well as providing a customizable sleeve that you can slide over the mesh back for an upholstered look and feel. Whether you are in the market to find an ergonomic chair to boost comfort and productivity or a family of chairs to spice up the office, our task/conference seating has the exact chair to fit your wants and needs.

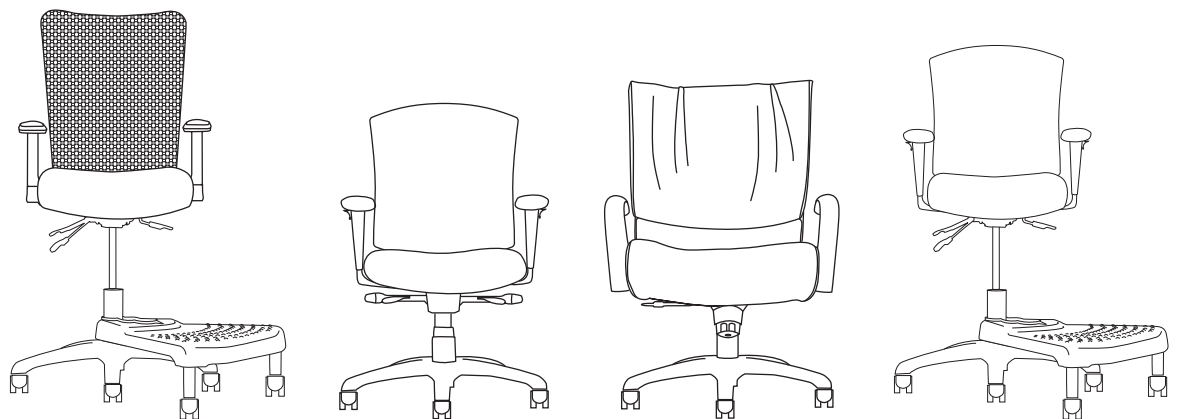

# TASK/CONFERENCE SEATING

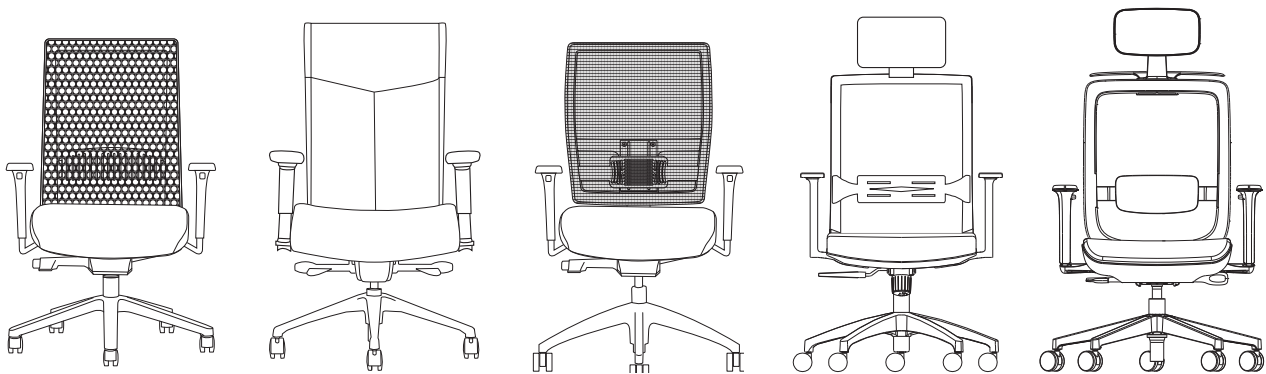

# Arm Options

Standard Arms

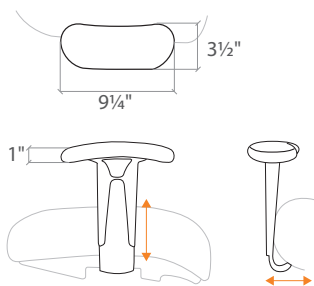

## 0 4" ADJUSTABLE

Arm Height	7.0 – 11.0
Arm Width	17.5 – 21.5
Arm Pivot	fixed
Weight	7 lbs

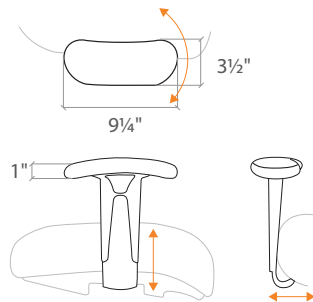

## 1 4" ADJ. W/PIVOT

Arm Height	7.0 – 11.0
Arm Width	17.5 – 21.5
Arm Pivot	25° range
Weight	7 lbs

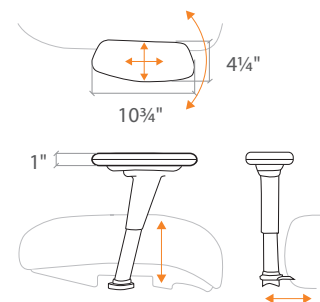

## 2 LATERAL SLIDING

Arm Height	7.0 – 11.0
Arm Width	17.5 – 21.5
Arm Pivot	30° range
Weight	7 lbs

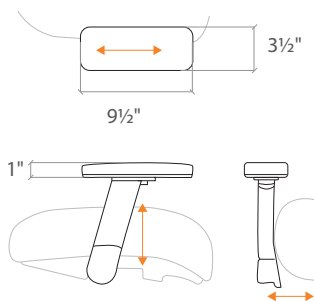

## 3 3" ADJUSTABLE

Arm Height	7.5 – 11.0
Arm Width	18.0 – 24.0
Arm Pivot	fixed
Weight	6 lbs

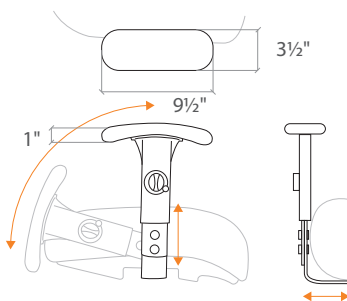

## 4 SWING

Arm Height	7.0 – 10.0
Arm Width	17.75 – 22.0
Arm Pivot	fixed
Weight	7 lbs

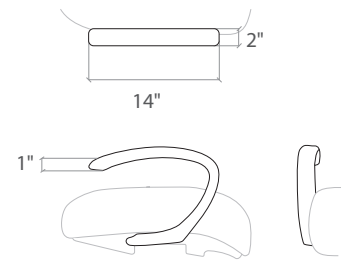

## 6 CLOOP

Arm Height	7.5
Arm Width	22.5
Arm Pivot	fixed
Weight	5 lbs

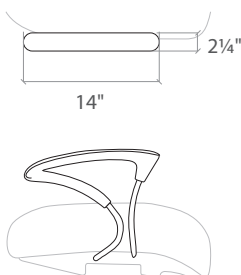

## 7 CHROME LOOP

Arm Height	7.5
Arm Width	22.25
Arm Pivot	fixed
Weight	5 lbs

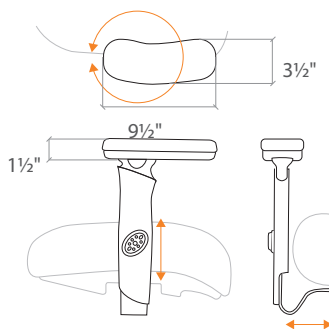

## 8 360° NP

Arm Height	7.0 – 11.0
Arm Width	18 – 22
Arm Pivot	360° range
Weight	7 lbs

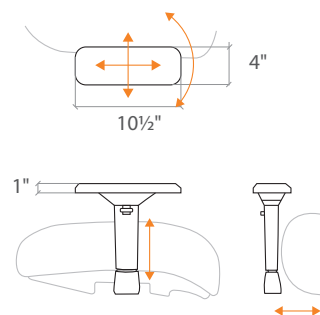

## 9 5-WAY ADJUSTABLE

Arm Height	7.0 – 10.0
Arm Width	16.5 – 23.5
Arm Pivot	15° range
Weight	6 lbs

# Arm Options

## Knomi and Ulius Arms

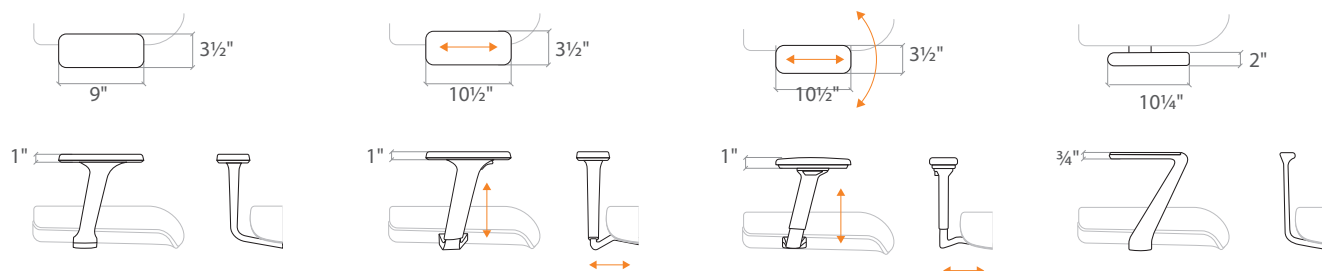

### 0 FIXED

Arm Height	7
Arm Width	19.75
Arm Pivot	fixed
Weight	4 lbs

### 3 3D

Arm Height	6 – 9
Arm Width	18 – 20.5
Arm Pivot	fixed
Weight	4 lbs

### 4 4D

Arm Height	6 – 9
Arm Width	18 – 20.5
Arm Pivot	30° range
Weight	4 lbs

### 7 CHROME LOOP

Arm Height	9
Arm Width	20.5
Arm Pivot	fixed
Weight	6 lbs

## Icon Arms

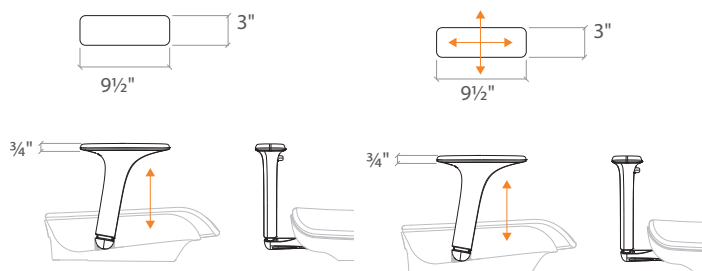

### 0 1D

Arm Height	7 – 10.5
Arm Width	19.5
Arm Pivot	fixed
Weight	4.5 lbs

### 3 3D

Arm Height	7 – 10.5
Arm Width	18.0 – 20.0
Arm Pivot	fixed
Weight	4.5 lbs

## Renati Arms

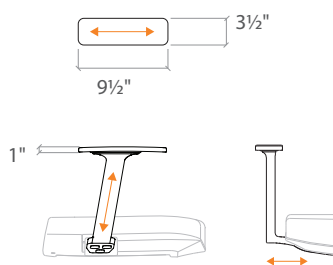

### 0 ADJUSTABLE

Arm Height	7.0 – 11.0
Arm Width	18.5 – 19.5
Arm Pivot	fixed
Weight	4 lbs

## Balance Arms

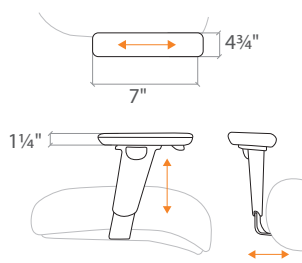

### 1 FORWARD SLIDING GELTHANE

Arm Height	7 – 10
Arm Width	19 – 23
Arm Pivot	fixed
Weight	4.5 lbs

All measurements are nominal and shown in inches.

## CHAIR MECHANISMS

Task/Conference



### 0 KNEE-TILT

- Swivel 360°
- Pneumatic seat height
- Seat tilt tension
- Back to seat tilt, 1:1
- Rock or lock recline

#### Available on

Balance  
Embrace



### 2 SYNCHRO

- Swivel 360°
- Pneumatic seat height
- Seat tilt tension
- Back angle
- Seat angle
- Back to seat tilt, 2:1
- Anti-kick tilt-lock
- Optional seat slider

#### Available on

Balance  
Cozi  
NV  
Right Chair  
U4ia

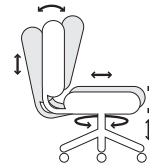

### 3 WEIGHT SENSITIVE

- Swivel 360°
- Pneumatic seat height
- Seat tilt tension
- Back angle
- Seat angle
- Back to seat tilt, 2:1
- Anti-kick tilt-lock
- Seat slider

#### Available on

Icon



### 4 TILT-SWIVEL

- Swivel 360°
- Pneumatic seat height
- Seat tilt tension
- Back to seat tilt, 1:1

#### Available on

Embrace  
Renati



### 6 MULTI-TILT

- Swivel 360°
- Pneumatic seat height
- Independent back angle
- Independent seat angle
- Seat tilt tension
- Infinite adjust forward tilt-stop
- Optional seat slider

#### Available on

Cozi  
E-Series  
Right Chair

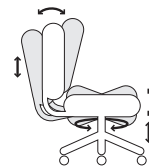

### 8 MULTI-TILT

- Swivel 360°
- Pneumatic seat height
- Independent back angle
- Independent seat angle
- Seat tilt tension
- Infinite adjust forward tilt-stop
- Seat slider

#### Available on

Cozi 24/7



## CHAIR MECHANISMS (Ulius & Knomi)

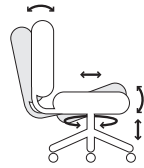

### 2 SYNCHRO

- Swivel 360°
- Pneumatic seat height
- Quick adjust seat tilt tension
- Back angle
- Seat angle
- Back to seat tilt, 2:1
- Adjustable anti-kick tilt-lock
- Seat slider

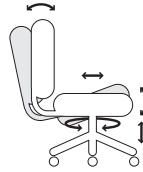

### 3 WEIGHT SENSITIVE

- Swivel 360°
- Pneumatic seat height
- Weight activated seat tilt tension
- Back angle
- Seat angle
- Back to seat tilt, 2:1
- Adjustable anti-kick tilt-lock
- Seat slider

## STOOL MECHANISMS

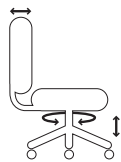

### 1 BASIC

- Swivel 360°
- Pneumatic seat height
- Back depth

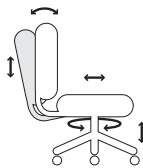

### 8 STANDARD

- Swivel 360°
- Pneumatic seat height
- Seat slider
- Independent back angle

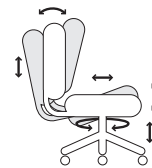

### 9 DELUXE-TILT

- Swivel 360°
- Pneumatic seat height
- Seat slider
- Seat angle
- Independent back angle

#### Available on

Cozi Stool  
Right Chair Stool  
U4ia Stool

#### Available on

Cozi Stool  
Right Chair Stool  
U4ia Stool

#### Available on

Cozi Stool  
Right Chair Stool  
U4ia Stool

# Headrest Options

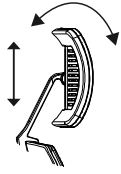

**H HEADREST**  
*Matching Upholstery*

- Height
- Angle

**Available on**  
Renati

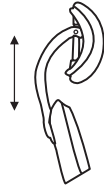

**HE SYNCHRO**  
*Black Vinyl*

- Height

**Available on**  
Right Chair  
Right Chair Stool

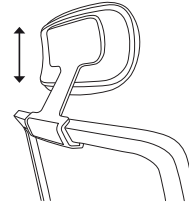

**H1 HEADREST**  
*Matching Upholstery*

- Height

**Available on**  
Icon

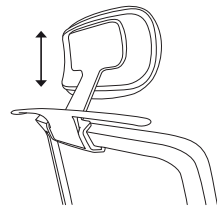

**H2 HEADREST W/COAT HANGER**  
*Matching Upholstery*

- Height
- Built-in coat hanger

**Available on**  
Icon

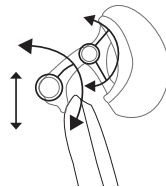

**H5 DUAL PIVOT**  
*Black Faux Leather*

- Height
- Depth
- 2 pivot points

**Available on**  
Right Chair  
Right Chair Stool

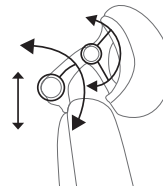

**H6 DUAL PIVOT**  
*Matching Upholstery*

- Height
- Depth
- 2 pivot points

**Available on**  
Cozi  
Cozi 24/7  
Cozi Stool



---

## CONNEXION® ARM

---

**THE ONLY GENUINE ERGONOMIC SOLUTION FOR THOSE WHO WORK INTENSELY WITH THEIR TABLET**

### FEATURES

- Quickly and easily position your tablet where it's comfortable for you
- Holds your tablet so you don't have to
- Eliminates awkward postures and helps reduce upper body fatigue
- Engineered for ease of use
- Can be used while sitting or standing
- 3 mounting options, left, right or both

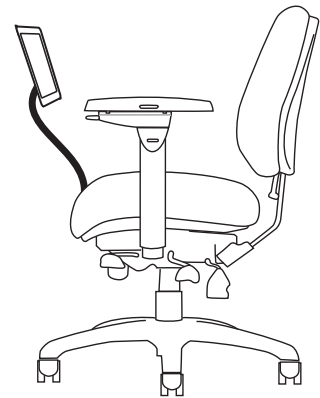
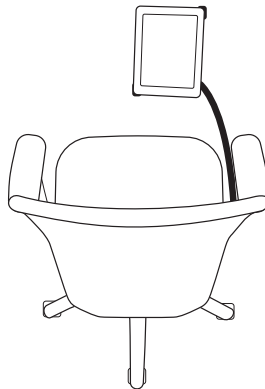
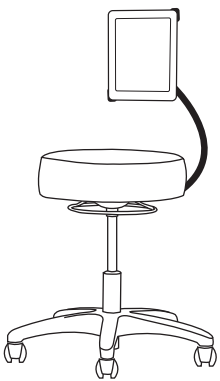

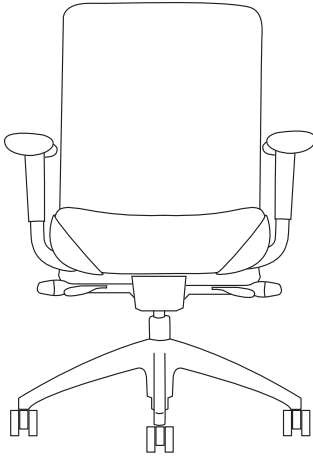

BAL5312







## Features

- Up to 11 active adjustments
- Mesh or upholstered back
- Passive weight dispersion design
- Generous foam for optimal comfort

## Standard Options

- No Arms
- Carpet Casters
- 26" High Crown Black Base
- 5" Cylinder

## Step 1 — Model Number

Series Code	Back	Seat	Select an Arm	Select a Mech																		
<b>BAL</b> Balance	<b>5</b> High Back	<b>3</b> Large Seat	<table border="0"> <tr> <td><b>1</b></td> <td>Forward Sliding Gelthane Pad</td> <td>\$205</td> </tr> <tr> <td><b>5</b></td> <td>No Arms</td> <td>\$0</td> </tr> <tr> <td><b>6</b></td> <td>C Loop</td> <td>\$75</td> </tr> <tr> <td><b>7</b></td> <td>Chrome Loop</td> <td>\$75</td> </tr> </table>	<b>1</b>	Forward Sliding Gelthane Pad	\$205	<b>5</b>	No Arms	\$0	<b>6</b>	C Loop	\$75	<b>7</b>	Chrome Loop	\$75	<table border="0"> <tr> <td><b>0</b></td> <td>Knee-tilt</td> <td></td> </tr> <tr> <td><b>2</b></td> <td>Synchro</td> <td></td> </tr> </table>	<b>0</b>	Knee-tilt		<b>2</b>	Synchro	
<b>1</b>	Forward Sliding Gelthane Pad	\$205																				
<b>5</b>	No Arms	\$0																				
<b>6</b>	C Loop	\$75																				
<b>7</b>	Chrome Loop	\$75																				
<b>0</b>	Knee-tilt																					
<b>2</b>	Synchro																					
<b>BAL</b>	<b>5</b>	<b>3</b>	<b>1</b>	<b>2</b>																		

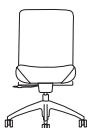
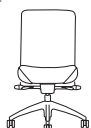
Knee-tilt	Synchro
	
<b>BAL5350</b>	<b>BAL5352</b>
\$1,014	\$1,092
\$1,074	\$1,152
\$1,134	\$1,212
\$1,204	\$1,282
\$1,274	\$1,352
\$1,354	\$1,432
\$1,434	\$1,512
\$1,524	\$1,602
\$1,614	\$1,692

38 x 26 x 26	39 x 26 x 26	Chair (H x W x D)
48.5 lbs	39 lbs	Chair Weight
22	22	Seat Width
16.5 – 21.5	16.5 – 21.5	Seat Height
17.5	16.5 – 19.5	Seat Depth (OPTIONAL)
F6° – R15°	F5° – R12°	Seat Angle
18.5	18.5	Back Width
22	22	Back Height
105° – 125°	102° – 125°	Back Angle
N/A	N/A	Lumbar Range
26	26	Base Diameter
2 yd	2 yd	COM Yardage
26 x 22 x 34	26 x 22 x 34	Shipping Box (L x W x H)
58.5 lbs	49 lbs	Shipping Weight
KD	KD	Shipping Method

All measurements are nominal and shown in inches.  
All upholstery subject to Neutral Posture approval.

**Step 2 — Add option codes after model number BAL5312-\_\_-\_\_**

General		Finishes		Bases		Casters/Glides					
<b>N</b>	<b>N-dulgent® Memory Foam</b> <i>Seat only</i>	<b>\$75</b>	<b>U2</b>	<b>Mesh Back</b>	<b>\$0</b>	<b>B0</b>	<b>26" Black</b>	<b>\$0</b>	<b>C1</b>	<b>Hard Floor</b>	<b>\$25</b>
<b>N2</b>	<b>ThermaGel Memory Foam</b> <i>Seat only</i>	<b>\$90</b>				<b>B6</b>	<b>26" Polished Aluminum</b>	<b>\$140</b>	<b>C2</b>	<b>Glides</b>	<b>\$25</b>
<b>S</b>	<b>Seat Slider</b> <i>Only available on (2) mech</i>	<b>\$75</b>				<b>B15</b>	<b>26" High Crown Polished Aluminum</b>	<b>\$55</b>	<b>C8</b>	<b>Chrome Carpet</b>	<b>\$90</b>
									<b>C9</b>	<b>Chrome Hard Floor</b>	<b>\$100</b>

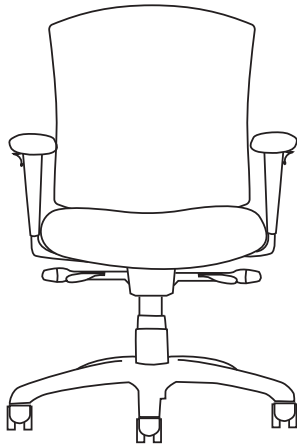

COZ5602

Task/Conference

**Features**

- Up to 13 active adjustments
- Standard with upholstered back outer
- Passive weight dispersion design
- Generous foam for optimal comfort
- Optional headrest

**Standard Features**

- No Arms
- Carpet Casters
- 26" Black Base
- 5" Cylinder

**Guardian®**

The Guardian is an NIJ Level II compliant bullet resistant vest that will provide protection against regular powered 9mm handguns, up to .357 Magnums. The vest fits over the back of the chair and is easily removable.

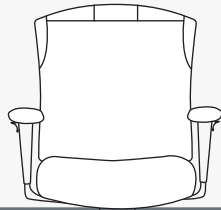

**Need it Now? 5-day Quick Ship**

Only standard features are available as Quick Ship unless otherwise noted.



**QUICK SHIP ARMS**







- 3 3" Adjustable Arms
- 5 No Arms
- 9 5-way Adjustable Arms

**QUICK SHIP FABRICS**

For available Quick Ship fabrics see page 8.

**Step 1 — Model Number**

Series Code	Select a Back	Select a Seat	Select an Arm	Select a Mech
COZ Cozi	5 Mid Back 6 High Back	6 Medium Seat 7 Large Seat	0 4" Adjustable \$125 1 4" Adjustable w/Pivot \$150 2 Lateral Sliding \$140 3 3" Adjustable \$75 4 Swing \$295 5 No Arms \$0 6 C Loop \$75 7 Chrome Loop \$75 9 5-way Adjustable \$150	2 Synchro  6 Multi-tilt 
<b>COZ</b>	<b>5</b>	<b>6</b>	<b>3</b>	<b>6</b>

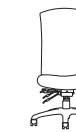
Synchro				Multi-tilt				
								
<b>COZ5652</b>	<b>COZ5752</b>	<b>COZ6652</b>	<b>COZ6752</b>	<b>COZ5656</b>	<b>COZ5756</b>	<b>COZ6656</b>	<b>COZ6756</b>	
\$811	\$862	\$913	\$964	\$887	\$938	\$989	\$1,040	<b>Grade 1</b>
\$871	\$922	\$973	\$1,024	\$947	\$998	\$1,049	\$1,100	<b>Grade 2</b>
\$931	\$982	\$1,033	\$1,084	\$1,007	\$1,058	\$1,109	\$1,160	<b>Grade 3</b>
\$1,001	\$1,052	\$1,103	\$1,154	\$1,077	\$1,128	\$1,179	\$1,230	<b>Grade 4</b>
\$1,071	\$1,122	\$1,173	\$1,224	\$1,147	\$1,198	\$1,249	\$1,300	<b>Grade 5</b>
\$1,151	\$1,202	\$1,253	\$1,304	\$1,227	\$1,278	\$1,329	\$1,380	<b>Grade 6</b>
\$1,231	\$1,282	\$1,333	\$1,384	\$1,307	\$1,358	\$1,409	\$1,460	<b>Grade 7</b>
\$1,321	\$1,372	\$1,423	\$1,474	\$1,397	\$1,448	\$1,499	\$1,550	<b>Grade 8</b>
\$1,411	\$1,462	\$1,513	\$1,564	\$1,487	\$1,538	\$1,589	\$1,640	<b>Grade 9</b>
39 x 26 x 26	39 x 26 x 26	43.5 x 26 x 26	43.5 x 26 x 26	39 x 26 x 26	39 x 26 x 26	43.5 x 26 x 26	43.5 x 26 x 26	Chair (H x W x D)
47 lbs	47 lbs	47 lbs	47 lbs	51 lbs	51 lbs	51 lbs	51 lbs	Chair Weight
19.5	22	19.5	22	19.5	22	19.5	22	Seat Width
16.5 – 21.5	16.5 – 21.5	16.5 – 21.5	16.5 – 21.5	16.5 – 21.5	16.5 – 21.5	16.5 – 21.5	16.5 – 21.5	Seat Height
16.5 – 19.5	16.5 – 19.5	16.5 – 19.5	16.5 – 19.5	16.5 – 19	16.5 – 19	16.5 – 19	16.5 – 19	Seat Depth (OPTIONAL)
F6° – R13°	F6° – R13°	F6° – R13°	F6° – R13°	F6° – R16°	F8° – R18°	F6° – R16°	F8° – R18°	Seat Angle
19	19	19	19	19	19	19	19	Back Width
21 – 24	21 – 24	26 – 29	26 – 29	22 – 25	22 – 25	24 – 27	24 – 27	Back Height
107° – 128°	107° – 128°	107° – 128°	107° – 128°	102° – 122°	102° – 122°	103° – 120°	103° – 120°	Back Angle
3	3	3	3	3	3	3	3	Lumbar Range
26	26	26	26	26	26	26	26	Base Diameter
2 yd	2 yd	2 yd	2 yd	2 yd	2 yd	2 yd	2 yd	COM Yardage
36 x 26 x 19	36 x 26 x 19	36 x 26 x 19	36 x 26 x 19	36 x 26 x 19	36 x 26 x 19	36 x 26 x 19	36 x 26 x 19	Shipping Box (L x W x H)
57 lbs	57 lbs	57 lbs	57 lbs	61 lbs	61 lbs	61 lbs	61 lbs	Shipping Weight
KD	KD	KD	KD	KD	KD	KD	KD	Shipping Method

All measurements are nominal and shown in inches.

## Step 2 — Add option codes after model number COZ5636 - \_ - \_

General	Casters/Glides	Cylinders	Connexion® Arm
<b>CR Cleanroom to Class 100</b> \$120	<b>C1 Hard Floor</b> \$25	<b>L1 3" Cylinder</b> \$0	<b>Z1 Connexion Arm</b> \$350 <i>Not available with (6) &amp; (7) arm</i>
<b>D2 Adjustable Lumbar Support</b> \$100	<b>C2 Glides</b> \$25	<b>L13 7" Dual Stage</b> \$55	<b>Connexion® Arm Attachments</b>
<b>E ESD*</b> \$290	<b>C3 Occupied Braking</b> \$185	<b>L14 10" Dual Stage</b> \$55	<b>A1 Tablet Holder</b> \$149 <i>Requires (Z1) Connexion Arm</i>
<b>F Fring® Footrest</b> \$50	<b>C4 Unoccupied Braking</b> \$60	<b>Headrest</b>	<b>Guardian – Bullet Resistant Vest</b>
<b>J Upholstered Arm Pad</b> \$65 <i>Only available on (B0) base</i>	<b>Bases</b>	<b>H6 Dual Pivot</b> \$280 <i>Matching upholstery</i>	<b>G Guardian</b> \$1,960 <i>Center or Ballistic Only</i>
<b>N N-dulgent® Memory Foam</b> \$125	<b>B6 26" Polished Aluminum</b> \$140		
<b>N2 ThermaGel Memory Foam</b> \$150	<b>B7 26" Black Aluminum</b> \$100		
<b>S Seat Slider</b> \$75	<b>B8 27" Brushed Aluminum</b> \$140		



COZ5638-L5-R8

Task/Conference

**Features**

- Up to 13 active adjustments
- Standard with upholstered back outer
- Passive weight dispersion design
- Generous foam for optimal comfort
- Optional headrest

**Standard Features**

- No Arms
- Carpet Casters
- 26" Black Base
- 8" Cylinder

**Guardian®**

The Guardian is an NIJ Level II compliant bullet resistant vest that will provide protection against regular powered 9mm handguns, up to .357 Magnums. The vest fits over the back of the chair and is easily removable.

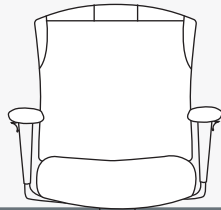

**Need it Now? 5-day Quick Ship**

Only standard features are available as Quick Ship unless otherwise noted.

**QUICK SHIP ARMS**

- 3 3" Adjustable Arms
- 5 No Arms
- 9 5-way Adjustable Arms







**QUICK SHIP FABRICS**

For available Quick Ship fabrics see page 8

**Step 1 — Model Number**

Series Code	Back	Select a Seat	Select an Arm	Select a Mech
<b>COZ</b> Cozi	<b>5</b> Mid Back	<b>6</b> Medium Seat <b>7</b> Large Seat	<b>0</b> 4" Adjustable \$125 <b>1</b> 4" Adjustable w/Pivot \$150 <b>2</b> Lateral Sliding \$140 <b>3</b> 3" Adjustable \$75 <b>4</b> Swing \$295 <b>5</b> No Arms \$0 <b>6</b> C Loop \$75 <b>7</b> Chrome Loop \$75 <b>9</b> 5-way Adjustable \$150	<b>1</b> Basic <b>8</b> Standard <b>9</b> Deluxe-tilt
<b>COZ</b>	<b>5</b>	<b>6</b>	<b>3</b>	<b>8</b>



Basic		Standard		Deluxe-tilt	
					
<b>COZ5651</b>	<b>COZ5751</b>	<b>COZ5658</b>	<b>COZ5758</b>	<b>COZ5659</b>	<b>COZ5759</b>
\$826	\$877	\$847	\$898	\$867	\$918
\$886	\$937	\$907	\$958	\$927	\$978
\$946	\$997	\$967	\$1,018	\$987	\$1,038
\$1,016	\$1,067	\$1,037	\$1,088	\$1,057	\$1,108
\$1,086	\$1,137	\$1,107	\$1,158	\$1,127	\$1,178
\$1,166	\$1,217	\$1,187	\$1,238	\$1,207	\$1,258
\$1,246	\$1,297	\$1,267	\$1,318	\$1,287	\$1,338
\$1,336	\$1,387	\$1,357	\$1,408	\$1,377	\$1,428
\$1,426	\$1,477	\$1,447	\$1,498	\$1,467	\$1,518
43 x 26 x 26	43 x 26 x 26	43.5 x 26 x 26	43.5 x 26 x 26	43.5 x 26 x 26	43.5 x 26 x 26
34 lbs	34 lbs	46 lbs	46 lbs	46 lbs	46 lbs
19.5	22	19.5	22	19.5	22
20.5 – 28.5	20.5 – 28.5	22 – 30	22 – 30	22 – 30	22 – 30
16.5 – 18.5	16.5 – 18.5	16.5 – 19	16.5 – 19	16.5 – 19	16.5 – 19
R4°	R4°	R3°	R3°	R4°	R4°
19	19	19	19	19	19
21.5 – 24	21.5 – 24	22 – 25	22 – 25	22 – 25	22 – 25
103°	103°	95° – 102°	95° – 102°	97° – 105°	97° – 105°
3	3	3	3	3	3
26	26	26	26	26	26
2 yd	2 yd	2 yd	2 yd	2 yd	2 yd
36 x 26 x 19	36 x 26 x 19	36 x 26 x 19	36 x 26 x 19	36 x 26 x 19	36 x 26 x 19
44 lbs	44 lbs	56 lbs	56 lbs	56 lbs	56 lbs
KD	KD	KD	KD	KD	KD

- Grade 1
- Grade 2
- Grade 3
- Grade 4
- Grade 5
- Grade 6
- Grade 7
- Grade 8
- Grade 9

- Chair (H x W x D)
- Chair Weight
- Seat Width
- Seat Height
- Seat Depth (OPTIONAL)
- Seat Angle
- Back Width
- Back Height
- Back Angle
- Lumbar Range
- Base Diameter
- COM Yardage
- Shipping Box (L x W x H)
- Shipping Weight
- Shipping Method

All measurements are nominal and shown in inches.

## Step 2 — Add option codes after model number COZ5638 - \_ - \_

<b>General</b>	<b>Bases</b>	<b>Connexion® Arm</b>	<b>Stool Cylinders</b>
<b>CR Cleanroom to Class 100</b> \$120	<b>B6 26" Polished Aluminum</b> \$140	<b>Z1 Connexion Arm</b> \$350 <i>Not available with (6) &amp; (7) arm</i>	<b>L5 10" Cylinder</b> \$0
<b>D2 Adjustable Lumbar Support</b> \$100	<b>B7 26" Black Aluminum</b> \$100		<b>L7 7" Cylinder</b> \$0
<b>E ESD*</b> \$290	<b>Chair Cylinders</b>	<b>Connexion® Arm Attachments</b>	<b>Footrings for stool cylinders only</b>
<b>J Upholstered Arm Pad</b> \$65 <i>Only available on (2) arm</i>	<b>L1 3" Cylinder</b> \$0	<b>A1 Tablet Holder</b> \$149 <i>Requires (Z1) Connexion Arm</i>	<b>R1 18" Black Plastic</b> \$60
<b>N N-dulgent® Memory Foam</b> \$125	<b>L3 5" Cylinder</b> \$0	<b>Guardian – Bullet Resistant Vest</b>	<b>R2 20" Chrome</b> \$80
<b>N2 ThermaGel Memory Foam</b> \$150	<b>L13 7" Dual Stage</b> \$0	<b>G Guardian</b> \$1,960 <i>Center or Ballistic Only</i>	<b>NeXtep® for stool cylinders only</b>
<b>Casters/Glides</b>	<b>L14 10" Dual Stage</b> \$0		<b>R8 8" w/Casters</b> \$185
<b>C1 Hard Floor</b> \$25	<b>Headrest</b>		<b>R10 10" w/Casters</b> \$185
<b>C2 Glides</b> \$25	<b>H6 Dual Pivot</b> \$280 <i>Matching upholstery</i>		<b>R18 8"/10" w/Casters</b> \$295
<b>C3 Occupied Braking</b> \$185			<b>RW8 Wide 8" w/Casters</b> \$295
<b>C4 Unoccupied Braking</b> \$60			<b>RW10 Wide 10" w/Casters</b> \$295
			<i>Also available w/glides.</i>

For additional stool options see page 110.

\*Contact Customer Service – customerservice@neutralposture.com

# Cozi® 24/7

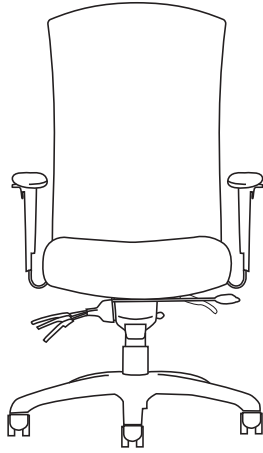

CZN6608

Task/Conference

## Features

- Up to 11 active adjustments
- Standard with upholstered back outer
- 24/7 Continuous-shift 5-year warranty only available on upholstery with a double rub rating of over 1,000,000
- Passive weight dispersion design
- Generous foam for optimal comfort
- Optional headrest

## Standard Features

- No Arms
- Carpet Casters
- 26" Black Base
- 5" Intensive Use Cylinder
- Seat Slider

## Guardian®

The Guardian is an NIJ Level II compliant bullet resistant vest that will provide protection against regular powered 9mm handguns, up to .357 Magnums. The vest fits over the back of the chair and is easily removable.

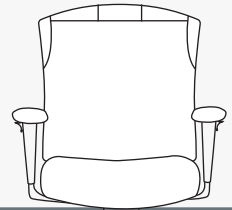

## Step 1 — Model Number

Series Code	Select a Back	Select a Seat	Select an Arm	Mech
<b>CZN</b> Cozi	<b>5</b> Mid Back <b>6</b> High Back	<b>6</b> Medium Seat <b>7</b> Large Seat <b>8</b> Extra Large Seat <i>Supports up to 400 lbs</i>	<b>0</b> 4" Adjustable <i>Not available on 8 seat</i> <b>4</b> Swing <b>5</b> No Arms <b>6</b> 360° w/Oversized Black Vinyl <b>7</b> 360° w/Oversized Fabric/Leather <b>8</b> 360° NP	<b>8</b> Multi-tilt 
<b>CZN</b>	<b>5</b>	<b>6</b>	<b>0</b>	<b>8</b>

Supports up to 350 lbs

Supports up to 400 lbs

Cozi® 24/7



CZN5658	CZN5758	CZN6658	CZN6758	CZN5858	CZN6858
\$1,076	\$1,112	\$1,163	\$1,188	\$1,341	\$1,418
\$1,136	\$1,172	\$1,223	\$1,248	\$1,401	\$1,478
\$1,196	\$1,232	\$1,283	\$1,308	\$1,461	\$1,538
\$1,266	\$1,302	\$1,353	\$1,378	\$1,531	\$1,608
\$1,336	\$1,372	\$1,423	\$1,448	\$1,601	\$1,678
\$1,416	\$1,452	\$1,503	\$1,528	\$1,681	\$1,758
\$1,496	\$1,532	\$1,583	\$1,608	\$1,761	\$1,838
\$1,586	\$1,622	\$1,673	\$1,698	\$1,851	\$1,928
\$1,676	\$1,712	\$1,763	\$1,788	\$1,941	\$2,018

Grade 1  
Grade 2  
Grade 3  
Grade 4  
Grade 5  
Grade 6  
Grade 7  
Grade 8  
Grade 9

39 x 26 x 26	39 x 26 x 26	43 x 26 x 26	43 x 26 x 26	39 x 26 x 26	41 x 26 x 26	Chair (H x W x D)
51.5 lbs	51.5 lbs	52 lbs	52 lbs	59 lbs	59 lbs	Chair Weight
19.5	22	19.5	22	23	23	Seat Width
16.5 – 21.5	16.5 – 21.5	16.5 – 21.5	16.5 – 21.5	19.25 – 23.75	19.25 – 23.75	Seat Height
16 – 18	16 – 18	16 – 18	16 – 18	19 – 21	19 – 21	Seat Depth
F5° – R10°	F8° – R18°	F5° – R10°	F8° – R18°	F5° – R10°	F5° – R10°	Seat Angle
19	19	19	19	19	19	Back Width
22 – 25	22 – 25	23 – 26	23 – 26	20 – 23	22 – 25	Back Height
105° – 120°	105° – 120°	105° – 120°	105° – 120°	105° – 120°	105° – 120°	Back Angle
3	3	3	3	3	3	Lumbar Range
26	26	26	26	26	26	Base Diameter
2 yd	2 yd	2 yd	2 yd	3 yd	3 yd	COM Yardage
36 x 26 x 19	36 x 26 x 19	36 x 26 x 19	36 x 26 x 19	28 x 26 x 24	28 x 26 x 24	Shipping Box (L x W x H)
61.5 lbs	61.5 lbs	62 lbs	62 lbs	69 lbs	69 lbs	Shipping Weight
KD	KD	KD	KD	KD	KD	Shipping Method

All measurements are nominal and shown in inches.  
Specs may differ for stools.

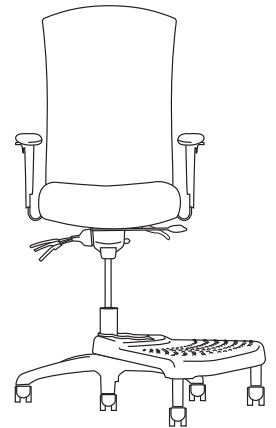

CZN6608-L5-R8

## Step 2 — Add option codes after model number COZ5638 - \_\_ - \_\_

### General

<b>CR</b>	Cleanroom to Class 100	\$120
<b>D2</b>	Adjustable Lumbar Support	\$100
<b>E</b>	ESD*	\$290
<b>N</b>	N-dulgent® Memory Foam	\$125
<b>N2</b>	ThermaGel Memory Foam	\$150

### Finishes

<b>U1</b>	Ballistic Upholstery	\$0
	<i>Back outer</i>	

### Casters/Glides

<b>C1</b>	Hard Floor	\$25
-----------	------------	------

### Bases

<b>B7</b>	26" Black Aluminum	\$100
<b>B8</b>	27" Brushed Aluminum	\$140
<b>B14</b>	28" Intensive Use Black	\$125

### Chair Cylinders

<b>L1</b>	3" Cylinder	\$0
<b>L13</b>	7" Dual Stage	\$55
<b>L14</b>	10" Dual Stage	\$55

### Headrest

<b>H6</b>	Dual Pivot	\$280
	<i>Matching upholstery</i>	

### Guardian – Bullet Resistant Vest

<b>G</b>	Guardian	\$1,960
	<i>Center or Ballistic Only</i>	

## Stool Options

Not available on (8) seat

### Stool Cylinders

<b>L4</b>	8" Cylinder	\$55
<b>L5</b>	10" Cylinder	\$55
<b>L7</b>	7" Cylinder	\$55

### Footrings for stool cylinders only

<b>R1</b>	18" Black Plastic	\$60
<b>R2</b>	20" Chrome	\$80

### NeXtep® for stool cylinders only

<b>R8</b>	8" w/Casters	\$185
<b>R10</b>	10" w/Casters	\$185
<b>R18</b>	8"/10" w/Casters	\$295
<b>RW8</b>	Wide 8" w/Casters	\$295
<b>RW10</b>	Wide 10" w/Casters	\$295

Also available w/glides.

For additional stool options see page 110.

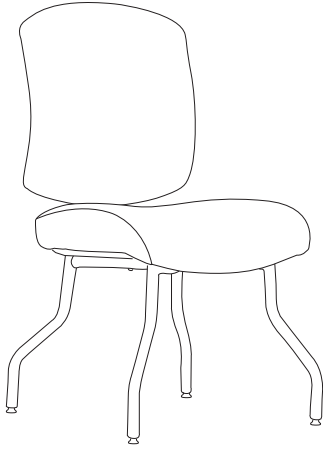

COG5654



**Features**

- Generous foam for optimal comfort
- Standard with upholstered back outer
- Passive weight dispersion design
- 2 base options

**Standard Features**

- No Arms
- Glides
- Black Frame

**Step 1 — Model Number**

Series Code	Back	Seat	Select an Arm	Select a Base
<b>COG</b> Cozi Guest	<b>5</b> Mid Back	<b>6</b> Medium Seat	<b>3</b> 3" Adjustable <i>Fixed Width</i> \$75 <b>5</b> No Arms \$0 <b>6</b> C Loop \$75 <b>7</b> Chrome Loop \$75	<b>4</b> 4-leg  <b>5</b> Sled 
<b>COG</b>	<b>5</b>	<b>6</b>	<b>5</b>	<b>4</b>

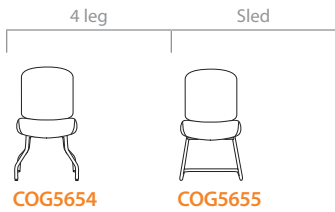

COG5654	COG5655
\$913	\$979
\$973	\$1,039
\$1,033	\$1,099
\$1,103	\$1,169
\$1,173	\$1,239
\$1,253	\$1,319
\$1,333	\$1,399
\$1,423	\$1,489
\$1,513	\$1,579

- Grade 1
- Grade 2
- Grade 3
- Grade 4
- Grade 5
- Grade 6
- Grade 7
- Grade 8
- Grade 9

37 x 20.5 x 24	36.5 x 20.5 x 24	Chair (H x W x D)
26.5 lbs	29.5 lbs	Chair Weight
19.5"	19.5"	Seat Width
18"	17.25"	Seat Height
18.5"	18.5"	Seat Depth
R3°	R4°	Seat Angle
19"	19"	Back Width
20"	20"	Back Height
109°	109°	Back Angle
20.5	20.5 x 23	Base Diameter
2 yd	2 yd	COM Yardage
30 x 27 x 39	30 x 27 x 39	Shipping Box (L x W x H)
36.5 lbs	39.5 lbs	Shipping Weight
FA	FA	Shipping Method

All measurements are nominal and shown in inches.

**Step 2** — Add option code after model number COG5654 - \_\_

General

<b>CB</b> Chrome Base	\$95
-----------------------	------

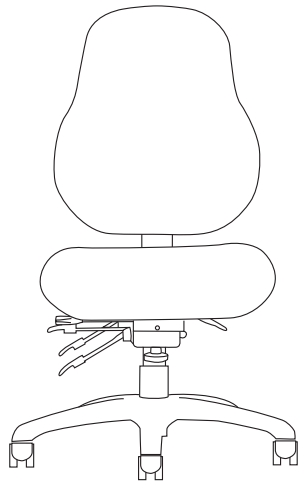

**ES3256**  
High Back

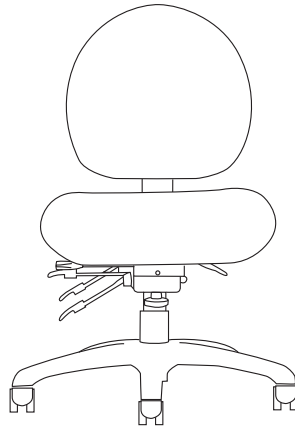

**ES2256**  
Mid Back

### Features

- Up to 13 active adjustments
- Contoured seat design
- Passive weight dispersion design
- Generous foam for optimal comfort
- Only available in Top Shelf, Cloud 9™ or Revive™

### Standard Features

- No Arms
- Carpet Casters
- 26" Black Base
- 5" Cylinder
- Seat Slider

### Need it Now? 5-day Quick Ship

Only standard features are available as Quick Ship unless otherwise noted.

#### QUICK SHIP ARMS

- 3 3" Adjustable Arms
- 5 No Arms
- 9 5-way Adjustable Arms

#### QUICK SHIP FABRICS

For available Quick Ship fabrics see page 8

## Step 1 — Model Number

Series Code	Select a Back	Seat	Select an Arm		Mech
<b>ES</b> E-Series	<ul style="list-style-type: none"> <li>2 Mid Back</li> <li>3 High Back</li> </ul>	<ul style="list-style-type: none"> <li>2 Medium Seat</li> </ul>	<ul style="list-style-type: none"> <li>0 4" Adjustable</li> <li>2 Lateral Sliding</li> <li>5 No Arms</li> <li>9 5-way Adjustable</li> </ul>	<ul style="list-style-type: none"> <li>\$125</li> <li>\$140</li> <li>\$0</li> <li>\$150</li> </ul>	<ul style="list-style-type: none"> <li>6 Multi-tilt</li> </ul> 
<b>ES</b>	<b>3</b>	<b>2</b>	<b>0</b>		<b>6</b>

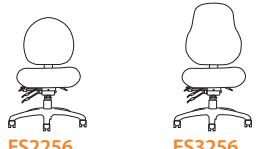

<b>ES2256</b>	<b>ES3256</b>
\$847	\$847
\$887	\$887
35.75 x 26 x 26	40 x 26 x 26
52.5 lbs	58 lbs
20.5	20.5
17.5 – 22.5	17.5 – 22.5
16 – 18	16 – 18
F1° – R16°	F1° – R16°
17.5	19.5
17 – 21	21 – 25
102° – 120°	97° – 112°
4	4
26	26
2 yd	2 yd
28 x 26 x 24	28 x 26 x 24
62.5 lbs	68 lbs
KD	KD

**Top Shelf**  
**Cloud 9 or Revive**

Chair (H x W x D)
Chair Weight
Seat Width
Seat Height
Seat Depth
Seat Angle
Back Width
Back Height
Back Angle
Lumbar Range
Arm Width
COM Yardage
Shipping Box (L x W x H)
Shipping Weight
Shipping Method

All measurements are nominal and shown in inches.  
Specs may differ for stools.

**Step 2 — Add option codes after model number ES3206 - \_\_ - \_\_**

General		
<b>F</b>	<b>Fring® Footrest</b>	\$50
	<i>Only available on (B0) base</i>	
Casters/Glides		
<b>C1</b>	<b>Hard Floor</b>	\$25

Chair Cylinders		
<b>L1</b>	<b>3" Cylinder</b>	\$0
<b>L13</b>	<b>7" Dual Stage</b>	\$55
<b>L14</b>	<b>10" Dual Stage</b>	\$55

Connexion® Arm		
<b>Z1</b>	<b>Connexion Arm</b>	\$350
Connexion® Arm Attachments		
<b>A1</b>	<b>Tablet Holder</b>	\$149
	<i>Requires (Z1) Connexion Arm</i>	

**Stool Options**

Stool Cylinders		
<b>L4</b>	<b>8" Cylinder</b>	\$55
<b>L5</b>	<b>10" Cylinder</b>	\$55
<b>L7</b>	<b>7" Cylinder</b>	\$55

Footrings for stool cylinders only		
<b>R1</b>	<b>18" Black Plastic</b>	\$60
<b>R2</b>	<b>20" Chrome</b>	\$80

NeXtep® for stool cylinders only		
<b>R8</b>	<b>8" w/Casters</b>	\$185
<b>R10</b>	<b>10" w/Casters</b>	\$185
<b>R18</b>	<b>8"/10" w/Casters</b>	\$295
<b>RW8</b>	<b>Wide 8" w/Casters</b>	\$295
<b>RW10</b>	<b>Wide 10" w/Casters</b>	\$295

Also available w/glides.

For additional stool options see page 110.



**EMB2124**  
Pulled Fabric

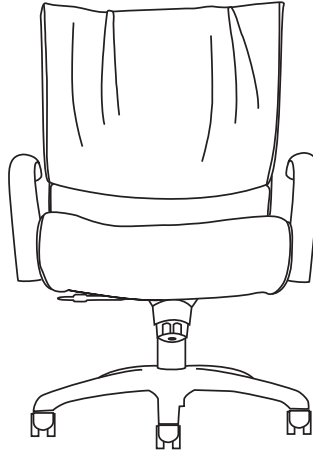

**EMB2124-PT**  
Pillow Top

## Features

- Up to 4 active adjustments
- Pillow top or pulled fabric upholstery
- Passive weight dispersion design
- Generous foam for optimal comfort
- Built-in lumbar

## Standard Features

- C Loop Arms
- Carpet Casters
- 26" Black Base



### TILT-SWIVEL

- 5" Cylinder







### KNEE-TILT

- 3" Cylinder

## Step 1 — Model Number

Series Code	Select a Back	Seat	Arm		Select a Base
<b>EMB</b> Embrace	1 Mid Back 2 High Back	1 Medium Seat	2 C Loop	\$0	4 Tilt-swivel  0 Knee-tilt 
<b>EMB</b>	<b>2</b>	<b>1</b>	<b>2</b>		<b>4</b>

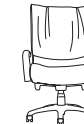

Tilt-swivel (Pulled)		Tilt-swivel (Pillow Top)		Knee-tilt (Pulled)		Knee-tilt (Pillow Top)		
								
<b>EMB1124</b>	<b>EMB2124</b>	<b>EMB1124-PT</b>	<b>EMB2124-PT</b>	<b>EMB1120</b>	<b>EMB2120</b>	<b>EMB1120-PT</b>	<b>EMB2120-PT</b>	
\$734	\$796	\$934	\$996	\$796	\$857	\$996	\$1,057	<b>Grade 1</b>
\$794	\$856	\$1,024	\$1,086	\$856	\$917	\$1,086	\$1,147	<b>Grade 2</b>
\$854	\$916	\$1,114	\$1,176	\$916	\$977	\$1,176	\$1,237	<b>Grade 3</b>
\$924	\$986	\$1,204	\$1,266	\$986	\$1,047	\$1,266	\$1,327	<b>Grade 4</b>
\$994	\$1,056	\$1,314	\$1,376	\$1,056	\$1,117	\$1,376	\$1,437	<b>Grade 5</b>
\$1,074	\$1,136	\$1,464	\$1,526	\$1,136	\$1,197	\$1,526	\$1,587	<b>Grade 6</b>
\$1,154	\$1,216	\$1,634	\$1,696	\$1,216	\$1,277	\$1,696	\$1,757	<b>Grade 7</b>
\$1,244	\$1,306	\$1,824	\$1,886	\$1,306	\$1,367	\$1,886	\$1,947	<b>Grade 8</b>
\$1,334	\$1,396	\$2,014	\$2,076	\$1,396	\$1,457	\$2,076	\$2,137	<b>Grade 9</b>
36 x 26 x 26	40 x 26 x 26	36 x 26 x 26	40 x 26 x 26	38.5 x 26 x 28	42.5 x 26 x 28	38.5 x 26 x 28	42.5 x 26 x 28	Chair (H x W x D)
57 lbs	57 lbs	57 lbs	57 lbs	57 lbs	57 lbs	57 lbs	57 lbs	Chair Weight
21	21	21	21	21	21	21	21	Seat Width
15.5 – 20.5	15.5 – 20.5	15.5 – 20.5	15.5 – 20.5	18 – 21	18 – 21	18 – 21	18 – 21	Seat Height
19.5	19.5	19.5	19.5	19.5	19.5	19.5	19.5	Seat Depth
R6° – F23°	R6° – F23°	R6° – F23°	R6° – F23°	R7° – F24°	R7° – F24°	R7° – F24°	R7° – F24°	Seat Angle
22	22	22	22	22	22	22	22	Back Width
22	25	22	25	22	25	22	25	Back Height
N/A	N/A	N/A	N/A	N/A	N/A	N/A	N/A	Back Angle
8	8	8	8	8	8	8	8	Arm Height
21.75	21.75	21.75	21.75	21.75	21.75	21.75	21.75	Arm Width
26	26	26	26	26	26	26	26	Base Diameter
2 yd	2 yd	2 yd	2 yd	2 yd	2 yd	2 yd	2 yd	COM Yardage – <i>Pulled</i>
4.5 yd	4.5 yd	4.5 yd	4.5 yd	4.5 yd	4.5 yd	4.5 yd	4.5 yd	COM Yardage – <i>Pillow Top</i>
37 x 23 x 22	37 x 23 x 22	37 x 23 x 22	37 x 23 x 22	37 x 23 x 22	37 x 23 x 22	37 x 23 x 22	37 x 23 x 22	Shipping Box (L x W x H)
67 lbs	67 lbs	67 lbs	67 lbs	67 lbs	67 lbs	67 lbs	67 lbs	Shipping Weight
KD	KD	KD	KD	KD	KD	KD	KD	Shipping Method

All measurements are nominal and shown in inches.  
 Not available in Cloud 9™, M Plus, Revive™ or Top Shelf upholstery.

**Step 2 — Add option code after model number EMB2124 - \_\_\_**

Finishes	Cylinders	Casters/Glides
<b>CP Chrome Package</b> <i>Chrome loop arm &amp; polished aluminum base. Ships fully assembled</i>	<b>L13 7" Dual Stage</b> <b>L14 10" Dual Stage</b>	<b>C1 Hard Floor</b>
\$295	\$55	\$25
	\$55	

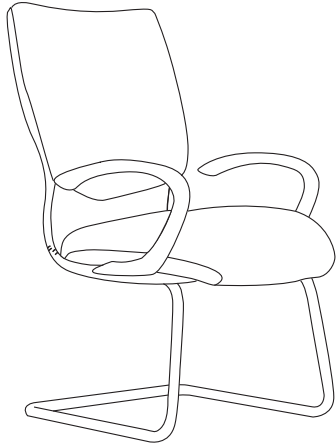

**EMC022**  
Pulled Fabric

Task/Conference

**Features**





- Generous amount of foam in seat and back
- Fully upholstered back
- Sturdy, cantilever steel base

**Standard Features**

- No Arms
- Black Cantilever Base

**Step 1 — Model Number**

Series Code	Back	Seat	Select an Arm
EMC Embrace Guest	0 Mid Back	2 Medium Seat	0 No Arms 2 C Loop
<b>EMC</b>	<b>0</b>	<b>2</b>	<b>2</b>

w/o Arms (Pulled)	w/o Arms (Pillow Top)	w/Arms (Pulled)	w/Arms (Pillow Top)
			
<b>EMC020</b>	<b>EMC020-PT</b>	<b>EMC022</b>	<b>EMC022-PT</b>
\$617	\$817	\$719	\$919
\$677	\$907	\$779	\$1,009
\$737	\$997	\$839	\$1,099
\$807	\$1,087	\$909	\$1,189
\$877	\$1,197	\$979	\$1,299
\$957	\$1,347	\$1,059	\$1,449
\$1,037	\$1,517	\$1,139	\$1,619
\$1,127	\$1,707	\$1,229	\$1,809
\$1,217	\$1,897	\$1,319	\$1,999

- Grade 1**
- Grade 2**
- Grade 3**
- Grade 4**
- Grade 5**
- Grade 6**
- Grade 7**
- Grade 8**
- Grade 9**

38.5 x 25 x 28	38.5 x 25 x 28	38.5 x 25 x 28	38.5 x 25 x 28
49 lbs	49 lbs	49 lbs	49 lbs
21	21	21	21
20	20	20	20
20.5	20.5	20.5	20.5
21	21	21	21
22	22	22	22
2 yd	2 yd	2 yd	2 yd
4.5 yd	4.5 yd	4.5 yd	4.5 yd
29 x 26.5 x 38	29 x 26.5 x 38	29 x 26.5 x 38	29 x 26.5 x 38
59 lbs	59 lbs	59 lbs	59 lbs
FA	FA	FA	FA

- Chair (H x W x D)
- Chair Weight
- Seat Width
- Seat Height
- Seat Depth
- Back Width
- Back Height
- COM Yardage – *Pulled Fabric*
- COM Yardage – *Pillow Top*
- Shipping Box (L x W x H)
- Shipping Weight
- Shipping Method

All measurements are nominal and shown in inches.  
Not available in Cloud 9™, M Plus, Revive™ or Top Shelf upholstery.

**Step 2 — Add option codes after model number EMC022 - \_\_ - \_\_**

**General**

- CB Chrome Base \$95**
- CP Chrome Package \$295**  
*Chrome loop arm & polished aluminum base*

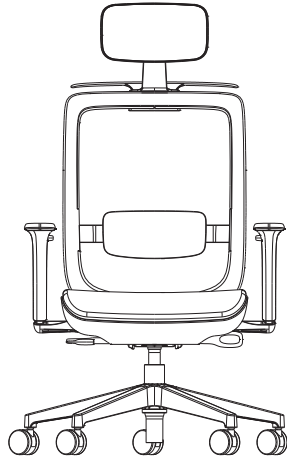

ICON4603-H2

Task/Conference

**Features**

- Medium gray mesh back
- Gray & black frame combination
- Replaceable/removable upholstered seat cushion – clips into place with no tools required
- Adjustable & removable lumbar support (easily slide up & down with no levers)
- Weight sensing mechanism without tension knob
- Finished seat bottom shell conceals mechanism
- 3 adjustment levers – height, synchro-tilt & seat slider

**Standard Features**

- No Arms
- Carpet Casters
- 26" Black Base
- 5" Cylinder
- Seat Slider
- N-dulgent® Memory Foam
- Adjustable Lumbar

**Need it Now? 5-day Quick Ship**

Only standard features are available as Quick Ship unless otherwise noted.

**QUICK SHIP ARMS**

0	1D
5	No Arms
3	3D

**QUICK SHIP FABRICS**

For available Quick Ship fabrics see page 8.

**Step 1 — Model Number**

Series Code	Select a Back	Seat	Select an Arm	Mech
<p><b>ICON</b> Icon</p>	<p>4 Mesh Back</p> <p>5 Upholstered Back</p>	<p>6 Medium Seat</p>	<p>0 1D \$40</p> <p>3 3D \$70</p> <p>5 No Arms \$0</p>	<p>3 Weight Sensitive</p> 
<b>ICON</b>	<b>4</b>	<b>6</b>	<b>0</b>	<b>3</b>

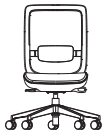

ICON4653



ICON5653

\$717	\$867	<b>Grade 1</b>
\$747	\$927	<b>Grade 2</b>
\$777	\$987	<b>Grade 3</b>
\$817	\$1,057	<b>Grade 4</b>
\$857	\$1,127	<b>Grade 5</b>
\$907	\$1,207	<b>Grade 6</b>
\$957	\$1,287	<b>Grade 7</b>
\$1,017	\$1,377	<b>Grade 8</b>
\$1,077	\$1,467	<b>Grade 9</b>

36.5 x 26 x 26	36.5 x 26 x 26	Chair (H x W x D)
36.5 lbs	36.5 lbs	Chair Weight
18.5	18.5	Seat Width
16 – 21	16 – 21	Seat Height
18 – 20	18 – 20	Seat Depth
R3° – R6°	R3° – R6°	Seat Angle
18	18	Back Width
20.5	20.5	Back Height
104° – 128°	104° – 128°	Back Angle
2.5	2.5	Lumbar Range
26	26	Base Diameter
1 yd	2 yd	COM Yardage
27 x 23 x 33	27 x 23 x 33	Shipping Box (L x W x H)
46.5 lbs	46.5 lbs	Shipping Weight
KD	KD	Shipping Method

All measurements are nominal and shown in inches. Specs may differ for stools.

ICONSC — Replacement Seat Cover	
Grade 1	\$100
Grade 2	\$130
Grade 3	\$160
Grade 4	\$200
Grade 5	\$240
Grade 6	\$290
Grade 7	\$340
Grade 8	\$400
Grade 9	\$460

Task/Conference

**Step 2 — Add option codes after model number ICON4603 - \_\_ - \_\_**

General		
<b>N2</b>	ThermaGel Memory Foam	\$90

Bases		
<b>B24</b>	26" Polished Aluminum	\$90

Casters/Glides		
<b>C1</b>	Hard Floor	\$25
<b>C2</b>	Glides	\$25

Cylinders		
<b>L13</b>	7" Dual Stage	\$55
<b>L14</b>	10" Dual Stage	\$55

Headrests		
<b>H1</b>	Headrest <i>Matching upholstery</i>	\$60
<b>H2</b>	Headrest w/Coat Hanger <i>Matching upholstery</i>	\$90

**Stool Options**

Stool Cylinders		
<b>L4</b>	8" Cylinder	\$55
<b>L5</b>	10" Cylinder	\$55
<b>L7</b>	7" Cylinder	\$55

Footrings for stool cylinders only		
<b>R1</b>	18" Black Plastic	\$60
<b>R2</b>	20" Chrome	\$80

NeXtep® for stool cylinders only		
<b>R9</b>	10" w/Glides	\$135
<b>R10</b>	10" w/Casters	\$185
<b>R21</b>	10"/12" w/Glides	\$235
<b>R22</b>	10"/12" w/Casters	\$295
<b>RW9</b>	Wide 10" w/Glides	\$235
<b>RW10</b>	Wide 10" w/Casters	\$295

For additional stool options see page 110.

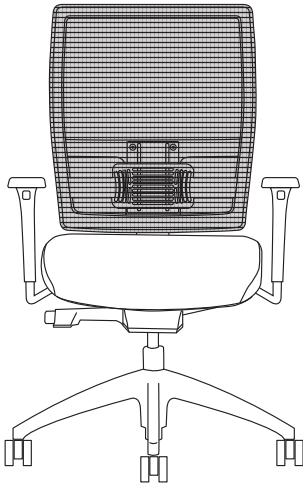

KNO4653

**Features**

- Mid and high mesh back options
- Adjustable lumbar support (easily slide up & down with no levers)
- Weight sensing mechanism without tension knob
- Height adjustable back
- Intuitive ergonomics

**Standard Features**

- No Arms
- Carpet Casters
- 26" High Crown Black Base
- 5" Cylinder
- Seat Slider
- Adjustable Lumbar
- Black Mesh

**Need it Now? 5-day Quick Ship**

**QS** Denotes Quick Ship models.

Only standard features are available as Quick Ship unless otherwise noted.



**QUICK SHIP ARMS**









- 3 3D
- 5 No Arms

**QUICK SHIP FABRICS**

For available Quick Ship fabrics see page 8.

**Step 1 — Model Number**

Series Code	Select a Back	Select a Seat	Select an Arm	Select a Mech
<b>KNO</b> Knomi	<ul style="list-style-type: none"> <li>4 Mesh Mid Back</li> <li>6 Mesh High Back</li> </ul>	<ul style="list-style-type: none"> <li>6 Medium Seat</li> <li>7 Large Seat</li> </ul>	<ul style="list-style-type: none"> <li>0 Fixed \$75</li> <li>3 3D \$75</li> <li>4 4D \$150</li> <li>5 No Arms \$0</li> <li>6 3D Chrome \$175</li> <li>7 Chrome Loop \$295</li> <li>8 4D Chrome \$250</li> </ul>	<ul style="list-style-type: none"> <li>2 <b>Synchro</b> </li> <li>3 <b>Weight Sensitive</b> </li> </ul>
<b>KNO</b>	<b>6</b>	<b>6</b>	<b>3</b>	<b>2</b>

Synchro				Weight Sensitive				
								
KNO4652	KNO4752	KNO6652	KNO6752	KNO4653	KNO4753	KNO6653	KNO6753	
\$865	\$905	\$965	\$1,005	\$825	\$865	\$925	\$965	<b>Grade 1</b>
\$895	\$935	\$995	\$1,035	\$855	\$895	\$955	\$995	<b>Grade 2</b>
\$925	\$965	\$1,025	\$1,065	\$885	\$925	\$985	\$1,025	<b>Grade 3</b>
\$965	\$1,005	\$1,065	\$1,105	\$925	\$965	\$1,025	\$1,065	<b>Grade 4</b>
\$1,005	\$1,045	\$1,105	\$1,145	\$965	\$1,005	\$1,065	\$1,105	<b>Grade 5</b>
\$1,055	\$1,095	\$1,155	\$1,195	\$1,015	\$1,055	\$1,115	\$1,155	<b>Grade 6</b>
\$1,105	\$1,145	\$1,205	\$1,245	\$1,065	\$1,105	\$1,165	\$1,205	<b>Grade 7</b>
\$1,165	\$1,205	\$1,265	\$1,305	\$1,125	\$1,165	\$1,225	\$1,265	<b>Grade 8</b>
\$1,225	\$1,265	\$1,325	\$1,365	\$1,185	\$1,225	\$1,285	\$1,325	<b>Grade 9</b>
35.5 x 26 x 26	35.5 x 26 x 26	40.5 x 26 x 26	40.5 x 26 x 26	35 x 26 x 26	35 x 26 x 26	40 x 26 x 26	40 x 26 x 26	Chair (H x W x D)
28 lbs	28 lbs	29 lbs	29 lbs	28 lbs	28 lbs	29 lbs	29 lbs	Chair Weight
19.5	21	19.5	21	19.5	21	19.5	21	Seat Width
17.25 – 22.25	17.25 – 22.25	17.25 – 22.25	17.25 – 22.25	17 – 22	17 – 22	17 – 22	17 – 22	Seat Height
17 – 19	17.5 – 19.5	17 – 19	17.5 – 19.5	17 – 19	17.5 – 19.5	17 – 19	17.5 – 19.5	Seat Depth
0° – R5.5°	0° – R5.5°	0° – R5.5°	0° – R5.5°	0° – R5.5°	0° – R5.5°	0° – R5.5°	0° – R5.5°	Seat Angle
20	20	19.5	19.5	20	20	19.5	19.5	Back Width
17 – 19	17 – 19	22 – 24	22 – 24	17 – 19	17 – 19	22 – 24	22 – 24	Back Height
102° – 123°	102° – 123°	102° – 123°	102° – 123°	102° – 123°	102° – 123°	102° – 123°	102° – 123°	Back Angle
3.5 – 8.5	3.5 – 8.5	3.5 – 8.5	3.5 – 8.5	3.5 – 8.5	3.5 – 8.5	3.5 – 8.5	3.5 – 8.5	Lumbar Range
26	26	26	26	26	26	26	26	Base Diameter
1	1	1	1	1	1	1	1	COM Yardage
36 x 26 x 19	36 x 26 x 19	36 x 26 x 19	36 x 26 x 19	36 x 26 x 19	36 x 26 x 19	36 x 26 x 19	36 x 26 x 19	Shipping Box (L x W x H)
38 lbs	38 lbs	39 lbs	39 lbs	38 lbs	38 lbs	39 lbs	39 lbs	Shipping Weight
KD	KD	KD	KD	KD	KD	KD	KD	Shipping Method

All measurements are nominal and shown in inches.

**Step 2 — Add option codes after model number KNO5636 - \_ - \_**

General		Mesh Color		Casters/Glides		Cylinders					
<b>N</b>	N-dulgent® Memory Foam	\$75	<b>M1</b>	Navy	\$50	<b>C1</b>	Hard Floor	\$25	<b>L1</b>	3" Cylinder	\$0
<b>N2</b>	ThermaGel Memory Foam	\$90	<b>M3</b>	Beige	\$50	<b>C2</b>	Glides	\$25			
			<b>M5</b>	Silver	\$50	<b>C8</b>	Chrome Carpet	\$90	<b>Headrest</b>		
			<b>Bases</b>			<b>C9</b>	Chrome Hard Floor	\$100	<b>H</b>	Headrest	\$95
			<b>B15</b>	26" High Crown Polished Aluminum	\$55				<i>Black vinyl</i>		

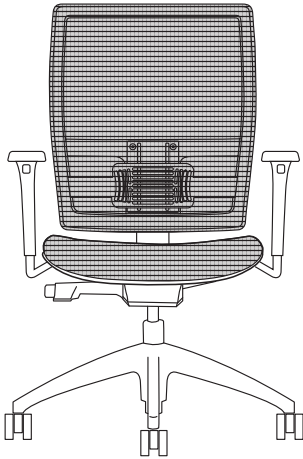

**KNO6353**

Task/Conference

**Features**

- Breathable mesh seat & back
- Adjustable lumbar
- Height adjustable back
- Intuitive ergonomics

**Standard Features**

- No Arms
- Carpet Casters
- 26" High Crown Black Base
- 5" Cylinder
- Seat Slider
- Adjustable Lumbar
- Black Mesh

**Need it Now? 5-day Quick Ship**

Only standard features are available as Quick Ship unless otherwise noted.



**QUICK SHIP ARMS**

- 3 3D
- 5 No Arms





**QUICK SHIP FABRICS**

For available Quick Ship fabrics see page 8.

**Step 1 — Model Number**

Series Code	Select a Back	Select a Seat	Select an Arm	Select a Mech
<b>KNO</b> Knomi	<ul style="list-style-type: none"> <li>4 Mesh Mid Back</li> <li>6 Mesh High Back</li> </ul>	<ul style="list-style-type: none"> <li>3 Mesh Seat</li> </ul>	<ul style="list-style-type: none"> <li>0 Fixed \$75</li> <li>3 3D \$75</li> <li>4 4D \$150</li> <li>5 No Arms \$0</li> <li>6 3D Chrome \$175</li> <li>7 Chrome Loop \$295</li> <li>8 4D Chrome \$250</li> </ul>	<ul style="list-style-type: none"> <li>2 Synchro </li> <li>3 Weight Sensitive </li> </ul>
<b>KNO</b>	<b>6</b>	<b>3</b>	<b>3</b>	<b>2</b>



Synchro		Weight Sensitive	
			
<b>KNO4352</b>	<b>KNO6352</b>	<b>KNO4353</b>	<b>KNO6353</b>
\$939	\$989	\$899	\$949

**Mesh**

35.5 x 26 x 26	40.5 x 26 x 26	35.5 x 26 x 26	40.5 x 26 x 26	Chair (H x W x D)
28 lbs	29 lbs	28 lbs	29 lbs	Chair Weight
20	20	20	20	Seat Width
16.5 – 21.5	16.5 – 21.5	16.25 – 21.25	16.25 – 21.25	Seat Height
17 – 19	17 – 19	17 – 19	17 – 19	Seat Depth
F1° – R4.5°	F1° – R4.5°	F1° – R4.5°	F1° – R4.5°	Seat Angle
20	19.5	20	19.5	Back Width
17 – 19	22 – 24	17 – 19	22 – 24	Back Height
102° – 123°	102° – 123°	102° – 123°	102° – 123°	Back Angle
3.5 – 8.5	3.5 – 8.5	3.5 – 8.5	3.5 – 8.5	Lumbar Range
26	26	26	26	Base Diameter
N/A	N/A	N/A	N/A	COM Yardage
36 x 26 x 19	36 x 26 x 19	36 x 26 x 19	36 x 26 x 19	Shipping Box (L x W x H)
38 lbs	39 lbs	38 lbs	39 lbs	Shipping Weight
KD	KD	KD	KD	Shipping Method

All measurements are nominal and shown in inches.

**Step 2 — Add option codes after model number KNO6332 - \_\_ - \_\_**

<b>Bases</b>	<b>Casters/Glides</b>	<b>Cylinders</b>
<b>B15</b> 26" High Crown Polished Aluminum \$55	<b>C0</b> Carpet \$0 <b>C1</b> Hard Floor \$25 <b>C2</b> Glides \$25 <b>C8</b> Chrome Carpet \$90 <b>C9</b> Chrome Hard Floor \$100	<b>L1</b> 3" Cylinder \$0 <b>Headrest</b> <b>H</b> Headrest \$95 <i>Black vinyl</i>



NV3402

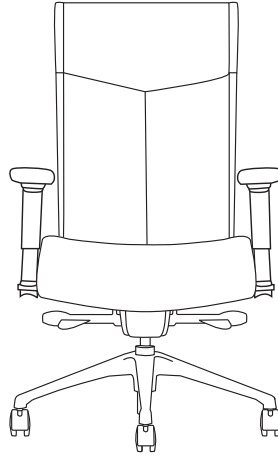

NV4122  
Pillow Top

**Features**

- Up to 13 active adjustments
- High back with built-in lumbar
- Contoured seat with waterfall
- Passive weight dispersion design
- Removable inner pad in upper back  
*Only available on (4) back*

**Standard Features**

- Lateral Sliding Arms
- 26" High Crown Black Base
- Carpet Casters
- 3" Cylinder
- Seat Slider

**Step 1 — Model Number**

Series Code	Select a Back	Select a Seat	Select an Arm	Mech
NV NV	<p>3 High Back</p> <p>4 High Back, Pillow Top</p>	<p>1 Medium Seat, Pillow Top</p> <p>2 Large Seat, Pillow Top</p> <p>4 Medium Seat</p>	<p>0 Polished Aluminum Loop \$0</p> <p>2 Lateral Sliding \$0</p> <p>5 No Arms (\$100)</p>	<p>2 Synchro</p> 
NV	4	1	2	2

Pillow Top Back



NV3422	NV3122	NV3222	NV4422	NV4122	NV4222	
\$1,377	\$1,428	\$1,479	\$1,479	\$1,530	\$1,581	Grade 1
\$1,447	\$1,498	\$1,549	\$1,549	\$1,600	\$1,651	Grade 2
\$1,517	\$1,568	\$1,619	\$1,619	\$1,670	\$1,721	Grade 3
\$1,597	\$1,648	\$1,699	\$1,699	\$1,750	\$1,801	Grade 4
\$1,677	\$1,728	\$1,779	\$1,779	\$1,830	\$1,881	Grade 5
\$1,767	\$1,818	\$1,869	\$1,869	\$1,920	\$1,971	Grade 6
\$1,857	\$1,908	\$1,959	\$1,959	\$2,010	\$2,061	Grade 7
\$1,957	\$2,008	\$2,059	\$2,059	\$2,110	\$2,161	Grade 8
\$2,057	\$2,108	\$2,159	\$2,159	\$2,210	\$2,261	Grade 9

41.5 x 26 x 26	41.5 x 26 x 26	41.5 x 26 x 26	42 x 26 x 26	42 x 26 x 26	42 x 26 x 26	Chair (H x W x D)
45.5 lbs	45.5 lbs	45.5 lbs	46.5 lbs	46.5 lbs	46.5 lbs	Chair Weight
19.5	20.5	20.5	19.5	20.5	20.5	Seat Width
18 - 21	19.5 - 22.5	19.5 - 22.5	18 - 21	19.5 - 22.5	19.5 - 22.5	Seat Height
18.5 - 21.5	15.5 - 18.5	19 - 22	18.5 - 21	18 - 20.5	18 - 20.5	Seat Depth
F5° - R10°	F5° - R10°	F5° - R10°	F6° - 12°	F8° - R14°	F8° - R14°	Seat Angle
19	19	19	19	19	19	Back Width
23.5 - 27.5	23.5 - 27.5	23.5 - 27.5	24 - 28	23.5 - 27.5	23.5 - 27.5	Back Height
100° - 115°	100° - 115°	100° - 115°	98° - 114°	100° - 115°	100° - 115°	Back Angle
4	4	4	4	4	4	Lumbar Range
26	26	26	26	26	26	Base Diameter
2.25 yd	2.25 yd	2.25 yd	3 yd	3 yd	3 yd	COM Yardage
28 x 28 x 42	28 x 28 x 42	28 x 28 x 42	28 x 28 x 42	28 x 28 x 42	28 x 28 x 42	Shipping Box (L x W x H)
65.5 lbs	65.5 lbs	65.5 lbs	66.5 lbs	66.5 lbs	66.5 lbs	Shipping Weight
FA	FA	FA	FA	FA	FA	Shipping Method

All measurements are nominal and shown in inches.  
 Not available in Cloud 9™, M Plus, Revive™ or Top Shelf upholstery.

Task/Conference

**Step 2 — Add option codes after model number NV4122 - \_ - \_**

General		Casters/Glides		Bases		Cylinders	
<b>D2</b>	<b>Adjustable Lumbar Support</b> \$100 <i>Not available on (3) back</i>	<b>C0</b>	<b>Carpet</b> \$0	<b>B0</b>	<b>26" Black</b> \$0	<b>L3</b>	<b>5" Cylinder</b> \$0
		<b>C1</b>	<b>Hard Floor</b> \$25	<b>B6</b>	<b>26" Polished Aluminum</b> \$140	<b>L13</b>	<b>7" Dual Stage</b> \$55
		<b>C8</b>	<b>Chrome Carpet</b> \$90	<b>B15</b>	<b>26" High Crown Polished Aluminum</b> \$55	<b>L14</b>	<b>10" Dual Stage</b> \$55
		<b>C9</b>	<b>Chrome Hard Floor</b> \$100	<b>B16</b>	<b>26" High Crown Black</b> \$0		
<b>Finishes</b>							
<b>J</b>	<b>Upholstered Arm Pad</b> \$65 <i>Only available on (2) arm</i>						

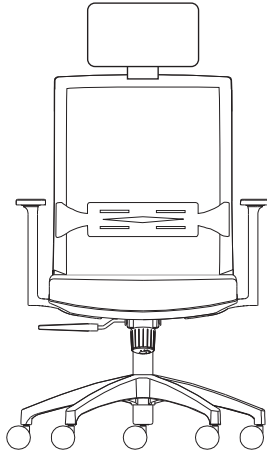

REN4604-H

**Features**

- Black mesh back & frame
- Tilt-swivel mechanism
- Heavy-duty casters & base

**Standard Features**

- No Arms
- Carpet Casters
- 26" Black Base
- 5" Cylinder
- Adjustable Lumbar

**Need it Now? 5-day Quick Ship**

Only standard features are available as Quick Ship unless otherwise noted.

**QUICK SHIP ARMS**

- 0 Adjustable Arms
- 5 No Arms

**QUICK SHIP FABRICS**

For available Quick Ship fabrics see page 8.

**Step 1 — Model Number**

Series Code	Back	Seat	Select an Arm	Mech
REN Renati	4 Mesh Back	6 Medium Seat	0 Adjustable Arms \$40 5 No Arms \$0	4 Tilt-swivel 
<b>REN</b>	<b>4</b>	<b>6</b>	<b>0</b>	<b>4</b>



**REN4654**

\$507	<b>Grade 1</b>
\$537	<b>Grade 2</b>
\$567	<b>Grade 3</b>
\$607	<b>Grade 4</b>
\$647	<b>Grade 5</b>
\$697	<b>Grade 6</b>
\$747	<b>Grade 7</b>
\$807	<b>Grade 8</b>
\$867	<b>Grade 9</b>

37 x 26 x 26	Chair (H x W x D)
28.5 lbs	Chair Weight
19.5	Seat Width
16 – 21	Seat Height
18.5	Seat Depth
F1° – R16°	Seat Angle
17.5	Back Width
21	Back Height
100° – 125°	Back Angle
2.5	Lumbar Range
26	Base Diameter
1 yd	COM Yardage
27 x 23 x 33	Shipping Box (L x W x H)
38.5 lbs	Shipping Weight
KD	Shipping Method

All measurements are nominal and shown in inches. Specs may differ for stools.

**Step 2 — Add option codes after model number REN4604 - \_\_ - \_\_ -**

**Stool Options**

General		Casters/Glides		Headrest		Stool Cylinders	
<b>N</b>	N-dulgent® Memory Foam \$75	<b>C0</b>	Carpet \$0	<b>H</b>	Headrest \$60	<b>L4</b>	8" Cylinder \$55
<b>N2</b>	ThermaGel Memory Foam \$90	<b>C1</b>	Hard Floor \$25		<i>Matching upholstery</i>	<b>L5</b>	10" Cylinder \$55
		<b>C2</b>	Glides \$25			<b>L7</b>	7" Cylinder \$55
Bases		Cylinders				Footrings for stool cylinders only	
<b>B24</b>	26" Polished Aluminum \$90	<b>L13</b>	7" Dual Stage \$55			<b>R1</b>	18" Black Plastic \$60
		<b>L14</b>	10" Dual Stage \$55			<b>R2</b>	20" Chrome \$80
						NeXtep® for stool cylinders only	
						<b>R9</b>	10" w/Glides \$135
						<b>R10</b>	10" w/Casters \$185
						<b>R21</b>	10"/12" w/Glides \$235
						<b>R22</b>	10"/12" w/Casters \$295
						<b>RW9</b>	Wide 10" w/Glides \$235
						<b>RW10</b>	Wide 10" w/Casters \$295

For additional stool options see page 110.

# Right Chair®

Task/Conference

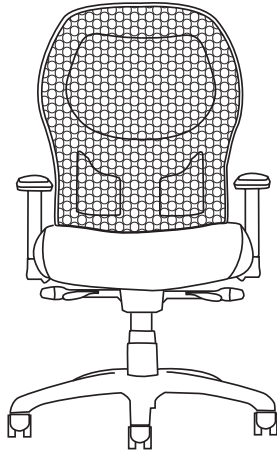

RCT4632

## Features

- Up to 13 active adjustments
- High mesh back & contoured seat design
- Passive weight dispersion design
- Generous foam for optimal comfort
- Convert mesh back to upholstered w/optional sleeve
- Independent lumbar adjustment
- 2 headrest options

## Standard Features

- No Arms
- 26" Black Base
- Carpet Casters
- 5" Cylinder
- Adjustable Lumbar

## Need it Now? 5-day Quick Ship

Only standard features are available as Quick Ship unless otherwise noted.



### QUICK SHIP ARMS





- 3 3" Adjustable
- 5 No Arms
- 9 5-way Adjustable

### QUICK SHIP FABRICS

For available Quick Ship fabrics see page 8.

## Step 1 — Model Number

Series Code	Back	Select a Seat	Select an Arm	Select a Mech
<b>RCT</b> Right Chair	<b>4</b> Mesh Back	<b>6</b> Medium Seat <b>7</b> Large Seat	<b>0</b> 4" Adjustable \$125 <b>1</b> 4" Adjustable w/Pivot \$150 <b>2</b> Lateral Sliding \$140 <b>3</b> 3" Adjustable \$75 <b>4</b> Swing \$295 <b>5</b> No Arms \$0 <b>6</b> C Loop \$75 <b>7</b> Chrome Loop \$75 <b>8</b> 360° NP \$175 <i>Only available on (2) synchro mech</i> <b>9</b> 5-way Adjustable \$150	<b>2</b> Synchro  <b>6</b> Multi-tilt 
<b>RCT</b>	<b>4</b>	<b>6</b>	<b>3</b>	<b>2</b>

Synchro		Multi-tilt	
			
<b>RCT4652</b>	<b>RCT4752</b>	<b>RCT4656</b>	<b>RCT4756</b>
\$842	\$893	\$918	\$969
\$872	\$923	\$948	\$999
\$902	\$953	\$978	\$1,029
\$942	\$993	\$1,018	\$1,069
\$982	\$1,033	\$1,058	\$1,109
\$1,032	\$1,083	\$1,108	\$1,159
\$1,082	\$1,133	\$1,158	\$1,209
\$1,142	\$1,193	\$1,218	\$1,269
\$1,202	\$1,253	\$1,278	\$1,329

- Grade 1
- Grade 2
- Grade 3
- Grade 4
- Grade 5
- Grade 6
- Grade 7
- Grade 8
- Grade 9

40.5 x 26 x 26	40.5 x 26 x 26	39.5 x 26 x 26	39.5 x 26 x 26	Chair (H x W x D)
37 lbs	37 lbs	48 lbs	48.5 lbs	Chair Weight
19.5	22	19.5	22	Seat Width
16.5 – 21.5	16.5 – 21.5	15.25 – 20.25	15.25 – 20.25	Seat Height
16.5 – 19.5	16.5 – 19.5	16 – 18	19 – 21	Seat Depth (OPTIONAL)
F5° – R14°	F5° – R14°	F6° – R11°	F8° – R18°	Seat Angle
19	19	19	19	Back Width
23	23	23	23	Back Height
102° – 120°	102° – 120°	100° – 115°	100° – 115°	Back Angle
4	4	4	4	Lumbar Range
26	26	26	26	Base Diameter
1 yd	1 yd	1 yd	1 yd	COM Yardage
28 x 26 x 24	28 x 26 x 24	28 x 26 x 24	28 x 26 x 24	Shipping Box (L x W x H)
47 lbs	47 lbs	58 lbs	58.5 lbs	Shipping Weight
KD	KD	KD	KD	Shipping Method

All measurements are nominal and shown in inches.

**Step 2 — Add option codes after model number RCT4632 - \_\_ - \_\_**

<b>General</b>	<b>Back Sleeve – Back of sleeve made w/Spacer</b>	<b>Bases</b>	<b>Connexion® Arm</b>
<b>F Fring® Footrest</b> \$50 <i>Only available on (B0) base</i>	<b>S1 Grade 1</b> \$110	<b>B6 26" Polished Aluminum</b> \$140	<b>Z1 Connexion Arm</b> \$350 <i>Not available with (6) &amp; (7) arm</i>
<b>J Upholstered Arm Pad</b> \$65 <i>Only available on (2) arm</i>	<b>S2 Grade 2</b> \$160	<b>B7 26" Black Aluminum</b> \$100	
<b>N N-dulgent® Memory Foam</b> \$75	<b>S3 Grade 3</b> \$200	<b>B8 27" Brushed Aluminum</b> \$140	<b>Connexion® Arm Attachments</b>
<b>N2 ThermaGel Memory Foam</b> \$90	<b>S4 Grade 4</b> \$240	<b>Cylinders</b>	<b>A1 Tablet Holder</b> \$149 <i>Requires (Z1) Connexion Arm</i>
<b>S Seat Slider</b> \$75	<b>S5 Grade 5</b> \$280	<b>L1 3" Cylinder</b> \$0	
	<b>S6 Grade 6</b> \$330	<b>L13 7" Dual Stage</b> \$55	
	<b>S7 Grade 7</b> \$380	<b>L14 10" Dual Stage</b> \$55	
	<b>S8 Grade 8</b> \$430		
	<b>S9 Grade 9</b> \$480		
	<b>Not available with a headrest</b>	<b>Headrests</b>	
		<b>HE Height Adjustable</b> \$60 <i>Black vinyl</i>	
	<b>Casters/Glides</b>	<b>H5 Dual Pivot</b> \$280 <i>Black faux leather</i>	
	<b>C1 Hard Floor</b> \$25		
	<b>C2 Glides</b> \$25		

# Right Chair®

Stool

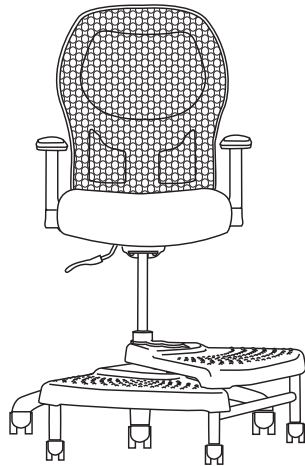

RCT4651

Task/Conference

## Features

- High mesh back & contoured seat design
- Passive weight dispersion design
- Generous foam for optimal comfort
- Convert mesh back to upholstered with optional sleeve
- Independent lumbar adjustment
- 2 headrest options

## Standard Features

- No Arms
- 26" Black Base
- Carpet Casters
- 8" Cylinder
- Adjustable Lumbar

## Need it Now? 5-day Quick Ship

Only standard features are available as Quick Ship unless otherwise noted.

### QUICK SHIP ARMS

- 3 3" Adjustable
- 5 No Arms
- 9 5-way Adjustable

### QUICK SHIP FABRICS

For available Quick Ship fabrics see page 8.

## Step 1 — Model Number

Series Code	Back	Select a Seat	Select an Arm	Select a Mech
<b>RCT</b> Right Chair	<b>4</b> Mesh Back	<b>6</b> Medium Seat <b>7</b> Large Seat	<b>0</b> 4" Adjustable \$125 <b>1</b> 4" Adjustable w/Pivot \$150 <b>2</b> Lateral Sliding \$140 <b>3</b> 3" Adjustable \$75 <b>4</b> Swing \$295 <b>5</b> No Arms \$0 <b>6</b> C Loop \$75 <b>7</b> Chrome Loop \$75 <b>8</b> 360° NP \$175 <b>9</b> 5-way Adjustable \$150	<b>1</b> Basic <b>8</b> Standard <b>9</b> Deluxe-tilt
<b>RCT</b>	<b>4</b>	<b>6</b>	<b>3</b>	<b>8</b>



Basic		Standard		Deluxe-tilt	
<b>RCT4651</b>	<b>RCT4751</b>	<b>RCT4658</b>	<b>RCT4758</b>	<b>RCT4659</b>	<b>RCT4759</b>
\$857	\$908	\$877	\$928	\$898	\$949
\$887	\$938	\$907	\$958	\$928	\$979
\$917	\$968	\$937	\$988	\$958	\$1,009
\$957	\$1,008	\$977	\$1,028	\$998	\$1,049
\$997	\$1,048	\$1,017	\$1,068	\$1,038	\$1,089
\$1,047	\$1,098	\$1,067	\$1,118	\$1,088	\$1,139
\$1,097	\$1,148	\$1,117	\$1,168	\$1,138	\$1,189
\$1,157	\$1,208	\$1,177	\$1,228	\$1,198	\$1,249
\$1,217	\$1,268	\$1,237	\$1,288	\$1,258	\$1,309
44.5 x 26 x 26	44.5 x 26 x 26	45 x 26 x 26	45 x 26 x 26	45 x 26 x 26	45 x 26 x 26
34.5 lbs	34.5 lbs	45.5 lbs	45.5 lbs	46 lbs	46 lbs
19.5	22	19.5	22	19.5	22
21 – 29	21.25 – 29.25	22.5 – 30.5	22.5 – 30.5	22.5 – 30.5	22.5 – 30.5
17 – 18	17 – 18	15.5 – 17.5	15.5 – 17.5	15.5 – 17.5	15.5 – 17.5
R4°	R4°	R3°	R3°	R4°	R4°
19	19	19	19	19	19
23	23	23	23	23	23
102°	102°	95° – 99°	95° – 99°	95° – 99°	95° – 99°
4	4	4	4	4	4
26	26	26	26	26	26
1 yd	1 yd	1 yd	1 yd	1 yd	1 yd
28 x 26 x 24	28 x 26 x 24	28 x 26 x 24	28 x 26 x 24	28 x 26 x 24	28 x 26 x 24
44.5 lbs	44.5 lbs	55.5 lbs	55.5 lbs	56 lbs	56 lbs
KD	KD	KD	KD	KD	KD

- Grade 1**
- Grade 2**
- Grade 3**
- Grade 4**
- Grade 5**
- Grade 6**
- Grade 7**
- Grade 8**
- Grade 9**

- Chair (H x W x D)
- Chair Weight
- Seat Width
- Seat Height
- Seat Depth (OPTIONAL)
- Seat Angle
- Back Width
- Back Height
- Back Angle
- Lumbar Range
- Base Diameter
- COM Yardage
- Shipping Box (L x W x H)
- Shipping Weight
- Shipping Method

All measurements are nominal and shown in inches.

**Step 2 — Add option codes after model number RCT4638 - \_ - \_**

<p><b>General</b></p> <p><b>J Upholstered Arm Pad</b> \$65 <i>Only available on (2) arm</i></p> <p><b>N N-dulgent® Memory Foam</b> \$75</p> <p><b>N2 ThermaGel Memory Foam</b> \$90</p> <p><b>Back Sleeve – Back of sleeve made w/Spacer</b></p> <p><b>S1 Grade 1</b> \$110</p> <p><b>S2 Grade 2</b> \$160</p> <p><b>S3 Grade 3</b> \$200</p> <p><b>S4 Grade 4</b> \$240</p> <p><b>S5 Grade 5</b> \$280</p> <p><b>S6 Grade 6</b> \$330</p> <p><b>S7 Grade 7</b> \$380</p> <p><b>S8 Grade 8</b> \$430</p> <p><b>S9 Grade 9</b> \$480</p> <p>Not available with a headrest</p>	<p><b>Casters/Glides</b></p> <p><b>C1 Hard Floor</b> \$25</p> <p><b>C2 Glides</b> \$25</p> <p><b>Bases</b></p> <p><b>B6 26" Polished Aluminum</b> \$140</p> <p><b>Headrests</b></p> <p><b>HE Height Adjustable</b> \$60 <i>Black vinyl</i></p> <p><b>H5 Dual Pivot</b> \$280 <i>Black faux leather</i></p>	<p><b>Chair Cylinders</b></p> <p><b>L1 3" Cylinder</b> \$0</p> <p><b>L3 5" Cylinder</b> \$0</p> <p><b>L13 7" Dual Stage</b> \$0</p> <p><b>L14 10" Dual Stage</b> \$0</p> <p><b>Stool Cylinders</b></p> <p><b>L5 10" Cylinder</b> \$0</p> <p><b>L7 7" Cylinder</b> \$0</p> <p><b>Connexion® Arm</b></p> <p><b>Z1 Connexion Arm</b> \$350 <i>Not available with (6) &amp; (7) arm</i></p> <p><b>Connexion® Arm Attachments</b></p> <p><b>A1 Tablet Holder</b> \$149 <i>Requires (Z1) Connexion Arm</i></p>	<p><b>Footrings for stool cylinders only</b></p> <p><b>R1 18" Black Plastic</b> \$60</p> <p><b>R2 20" Chrome</b> \$80</p> <p><b>NeXtep® for stool cylinders only</b></p> <p><b>R8 8" w/Casters</b> \$185</p> <p><b>R10 10" w/Casters</b> \$185</p> <p><b>R18 8"/10" w/Casters</b> \$295</p> <p><b>RW8 Wide 8" w/Casters</b> \$295</p> <p><b>RW10 Wide 10" w/Casters</b> \$295</p> <p>Also available w/glides.</p>
--	--	--	---

For additional stool options see page 110.

# Right Chair® Mesh

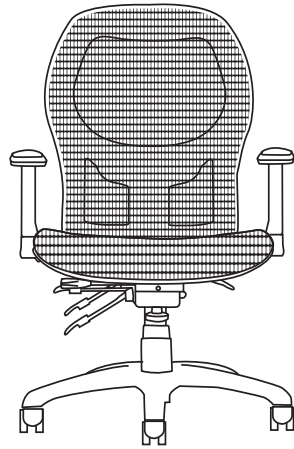

RCT5336

Task/Conference

## Features

- Breathable mesh seat & back
- Adjustable lumbar
- 2 headrest options

## Standard Features

- No Arms
- 26" Black Base
- Carpet Casters
- 5" Cylinder
- Adjustable Lumbar

## Need it Now? 5-day Quick Ship

Only standard features are available as Quick Ship unless otherwise noted.



### QUICK SHIP ARMS



- 3 3" Adjustable
- 5 No Arms
- 9 5-way Adjustable

### QUICK SHIP FABRICS

For available Quick Ship fabrics see page 8.

## Step 1 — Model Number

Series Code	Back	Seat	Select an Arm	Select a Mech
<b>RCT</b> Right Chair	<b>5</b> Mesh Back	<b>3</b> Mesh Seat	<ul style="list-style-type: none"> <li><b>2</b> Lateral Sliding \$140</li> <li><b>3</b> 3" Adjustable \$75</li> <li><b>5</b> No Arms \$0</li> <li><b>9</b> 5-way Adjustable \$150</li> </ul>	<ul style="list-style-type: none"> <li><b>2</b> Synchro-tilt </li> <li><b>6</b> Multi-tilt </li> </ul>
<b>RCT</b>	<b>5</b>	<b>3</b>	<b>3</b>	<b>2</b>

Synchro	Multi-tilt
	
<b>RCT5352</b>	<b>RCT5356</b>
\$918	\$995

**Mesh**

40.5 x 26 x 26	39.5 x 26 x 26	Chair (H x W x D)
41 lbs	41.5 lbs	Chair Weight
20	20	Seat Width
16.5 – 21.5	15.25 – 20.25	Seat Height
16.5 – 19.5	16.5 – 19	Seat Depth (OPTIONAL)
F1° – R5°	F6° – R11°	Seat Angle
19	19	Back Width
24	24	Back Height
100° – 120°	95° – 112°	Back Angle
4	4	Lumbar Range
26	26	Base Diameter
N/A	N/A	COM Yardage
28 x 26 x 24	28 x 26 x 24	Shipping Box (L x W x H)
51 lbs	51.5 lbs	Shipping Weight
KD	KD	Shipping Method

All measurements are nominal and shown in inches.

## Step 2 — Add option codes after model number RCT5332 - \_\_ - \_\_

General		Casters/Glides		Bases		Headrests					
<b>F</b>	<b>Fring® Footrest</b> <i>Only available on (B0) base</i>	\$50	<b>C1</b>	<b>Hard Floor</b>	\$25	<b>B6</b>	<b>26" Polished Aluminum</b>	\$140	<b>HE</b>	<b>Height Adjustable</b> <i>Black vinyl</i>	\$60
<b>J</b>	<b>Upholstered Arm Pad</b> <i>Only available on (2) arm</i>	\$65	<b>C2</b>	<b>Glides</b>	\$25	<b>Cylinders</b>			<b>H5</b>	<b>Dual Pivot</b> <i>Black faux leather</i>	\$280
<b>S</b>	<b>Seat Slider</b>	\$75				<b>L1</b>	<b>3" Cylinder</b>	\$0			
						<b>L13</b>	<b>7" Dual Stage</b>	\$55			
						<b>L14</b>	<b>10" Dual Stage</b>	\$55			

# Right Chair® Mesh Stool

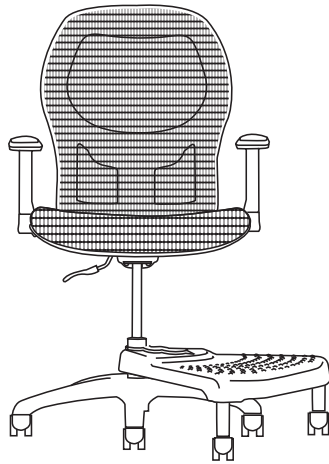

RCT5331-R10

Task/Conference

## Features

- Breathable mesh seat & back
- Adjustable lumbar
- 2 headrest options

## Standard Features

- No Arms
- 26" Black Base
- Carpet Casters
- 8" Cylinder
- Adjustable Lumbar

## Need it Now? 5-day Quick Ship

Only standard features are available as Quick Ship unless otherwise noted.

### QUICK SHIP ARMS



- 3 3" Adjustable
- 5 No Arms
- 9 5-way Adjustable

### QUICK SHIP FABRICS

For available Quick Ship fabrics see page 8.

## Step 1 — Model Number

Series Code	Back	Seat	Select an Arm		Select a Mech
<b>RCT</b> Right Chair	<b>5</b> Mesh Back	<b>3</b> Mesh Seat	<b>2</b> Lateral Sliding	\$140	<b>1</b> Basic
			<b>3</b> 3" Adjustable	\$75	
			<b>5</b> No Arms	\$0	<b>8</b> Standard
			<b>9</b> 5-way Adjustable	\$150	
					<b>9</b> Deluxe-tilt
<b>RCT</b>	<b>5</b>	<b>3</b>	<b>3</b>		<b>8</b>

Basic	Standard	Deluxe-tilt
		
<b>RCT5351</b>	<b>RCT5358</b>	<b>RCT5359</b>
\$1,010	\$1,030	\$1,051
44.5 x 26 x 26	45 x 26 x 26	45 x 26 x 26
34.5 lbs	45.5 lbs	46 lbs
20	20	20
20.75 – 28.75	21.5 – 29.5	21.5 – 29.5
17.75 – 18.75	16 – 18	15.5 – 17.5
R4°	R3°	R4°
19	19	19
23	23	23
102°	95° – 99°	95° – 99°
4	4	4
26	26	26
N/A	N/A	N/A
28 x 26 x 24	28 x 26 x 24	28 x 26 x 24
44.5 lbs	55.5 lbs	56 lbs
KD	KD	KD

## Mesh

- Chair (H x W x D)
- Chair Weight
- Seat Width
- Seat Height
- Seat Depth (OPTIONAL)
- Seat Angle
- Back Width
- Back Height
- Back Angle
- Lumbar Range
- Base Diameter
- COM Yardage
- Shipping Box (L x W x H)
- Shipping Weight
- Shipping Method

All measurements are nominal and shown in inches.

## Step 2 — Add option codes after model number RCT5338 - \_\_ - \_\_

<b>General</b>	<b>Chair Cylinders</b>	<b>Headrests</b>	<b>Footrings for stool cylinders only</b>
<b>J Upholstered Arm Pad</b> \$65 <i>Only available on (2) arm</i>	<b>L1 3" Cylinder</b> \$0	<b>HE Height Adjustable</b> \$60 <i>Black vinyl</i>	<b>R1 18" Black Plastic</b> \$60
	<b>L3 5" Cylinder</b> \$0		<b>R2 20" Chrome</b> \$80
	<b>L13 7" Dual Stage</b> \$0	<b>H5 Dual Pivot</b> \$280 <i>Black faux leather</i>	
<b>Casters/Glides</b>	<b>L14 10" Dual Stage</b> \$0		<b>NeXtep® for stool cylinders only</b>
<b>C1 Hard Floor</b> \$25	<b>Stool Cylinders</b>		<b>R8 8" w/Casters</b> \$185
<b>C2 Glides</b> \$25	<b>L5 10" Cylinder</b> \$0		<b>R10 10" w/Casters</b> \$185
<b>Bases</b>	<b>L7 7" Cylinder</b> \$0		<b>R18 8"/10" w/Casters</b> \$295
<b>B6 26" Polished Aluminum</b> \$140			<b>RW8 Wide 8" w/Casters</b> \$295
			<b>RW10 Wide 10" w/Casters</b> \$295
			<small>Also available w/glides.</small>

For additional stool options see page 110.

# Right Chair®

Guest

Task/Conference

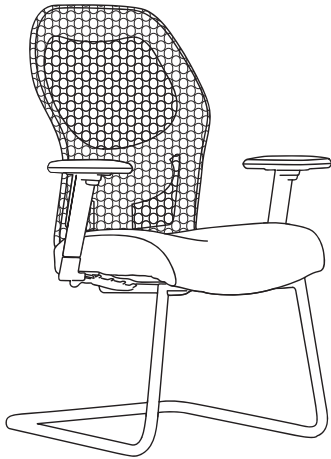

RCG4635



## Features

- High back & contoured seat design
- Passive weight dispersion design
- Generous foam for optimal comfort

## Standard Features

- No Arms
- Black Base

## Step 1 — Model Number

Series Code	Back	Seat	Select an Arm	Select a Base
<b>RCG</b> Right Chair Guest	<b>4</b> Mesh Back	<b>6</b> Medium Seat	<b>3</b> 3" Adjustable <i>Fixed Width</i> \$75 <b>5</b> No Arms \$0 <b>6</b> C Loop \$75 <b>7</b> Chrome Loop \$75	<b>4</b> 4-leg  <b>5</b> Sled 
<b>RCG</b>	<b>4</b>	<b>6</b>	<b>3</b>	<b>5</b>

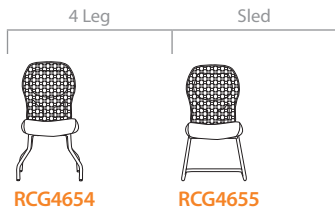

RCG4654	RCG4655
\$719	\$785
\$749	\$815
\$779	\$845
\$819	\$885
\$859	\$925
\$909	\$975
\$959	\$1,025
\$1,019	\$1,085
\$1,079	\$1,145

- Grade 1
- Grade 2
- Grade 3
- Grade 4
- Grade 5
- Grade 6
- Grade 7
- Grade 8
- Grade 9

40 x 20.5 x 24	39.5 x 20.5 x 24	Chair (H x W x D)
28 lbs	31 lbs	Chair Weight
19.5	19.5	Seat Width
18	17.25	Seat Height
17.5	17.5	Seat Depth
R3°	R4°	Seat Angle
19	19	Back Width
23	23	Back Height
100°	102°	Back Angle
4	4	Lumbar Range
20.5	20.5 x 23	Base Diameter
1 yd	1 yd	COM Yardage
30 x 27 x 39	30 x 27 x 39	Shipping Box (L x W x H)
38 lbs	41 lbs	Shipping Weight
FA	FA	Shipping Method

All measurements are nominal and shown in inches.

**Step 2 — Add option codes after model number RCG4635 - \_\_\_**

**General**

<b>CB</b>	<b>Chrome Base</b>	<b>\$95</b>
-----------	--------------------	-------------

**Back Sleeve – Back of sleeve made w/Spacer**

<b>S1</b>	<b>Grade 1</b>	<b>\$110</b>
<b>S2</b>	<b>Grade 2</b>	<b>\$160</b>
<b>S3</b>	<b>Grade 3</b>	<b>\$200</b>
<b>S4</b>	<b>Grade 4</b>	<b>\$240</b>
<b>S5</b>	<b>Grade 5</b>	<b>\$280</b>
<b>S6</b>	<b>Grade 6</b>	<b>\$330</b>
<b>S7</b>	<b>Grade 7</b>	<b>\$380</b>
<b>S8</b>	<b>Grade 8</b>	<b>\$430</b>
<b>S9</b>	<b>Grade 9</b>	<b>\$480</b>

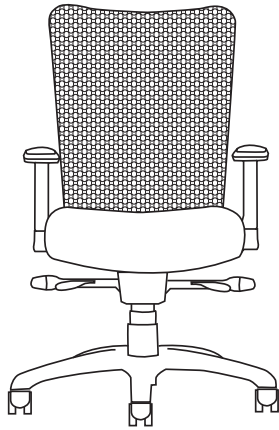

U4ia4600

**Features**

- Up to 13 active adjustments
- Height adjustable mesh back
- Passive weight dispersion design
- Generous foam for optimal comfort
- Optional removable back sleeve for an upholstered look & feel

**Standard Features**

- No Arms
- Carpet Casters
- 26" Black Base
- 5" Cylinder
- Black Mesh Back

**Need it Now? 5-day Quick Ship**

Only standard features are available as Quick Ship unless otherwise noted.

**QUICK SHIP ARMS**

3 3" Adjustable Arms

5 No Arms

9 5-way Adjustable Arms

**QUICK SHIP FABRICS**

For available Quick Ship fabrics see page 8.

**Step 1 — Model Number**

Series Code	Back	Select a Seat	Select an Arm	Mech
U4ia U4ia	4 Mid Back	6 Medium Seat 7 Large Seat	0 4" Adjustable \$125 1 4" Adjustable w/Pivot \$150 2 Lateral Sliding \$140 3 3" Adjustable \$75 4 Swing \$295 5 No Arms \$0 6 C Loop \$75 7 Chrome Loop \$75 9 5-way Adjustable \$150	2 Synchro 
<b>U4ia</b>	<b>4</b>	<b>6</b>	<b>3</b>	<b>2</b>



Synchro



<b>U4ia4652</b>	<b>U4ia4752</b>
\$791	\$842
\$821	\$872
\$851	\$902
\$891	\$942
\$931	\$982
\$981	\$1,032
\$1,031	\$1,082
\$1,091	\$1,142
\$1,151	\$1,202

- Grade 1**
- Grade 2**
- Grade 3**
- Grade 4**
- Grade 5**
- Grade 6**
- Grade 7**
- Grade 8**
- Grade 9**

38 x 26 x 26	38 x 26 x 26	Chair (H x W x D)
36 lbs	36 lbs	Chair Weight
19.5	22	Seat Width
16.5 – 21.5	16.5 – 21.5	Seat Height
16.5 – 19	16.5 – 19	Seat Depth (OPTIONAL)
F5° – R15°	F5° – R15°	Seat Angle
19	19	Back Width
20.5 – 23.5	20.5 – 23.5	Back Height
100° – 128°	100° – 128°	Back Angle
3	3	Lumbar Range
26	26	Base Diameter
1 yd	1 yd	COM Yardage
36 x 26 x 19	36 x 26 x 19	Shipping Box (L x W x H)
46 lbs	46 lbs	Shipping Weight
KD	KD	Shipping Method

All measurements are nominal and shown in inches.

**Step 2 — Add option codes after model number U4ia4632 - \_ - \_**

General		Back Sleeve (back of sleeve made w/Spacer)		Casters/Glides		Cylinders		
<b>F</b>	<b>Fring® Footrest</b> <i>Only available on (B0) base</i>	\$50	<b>S1</b> Grade 1	\$110	<b>C1</b> Hard Floor	\$25	<b>L1</b> 3" Cylinder	\$0
<b>J</b>	<b>Upholstered Arm Pad</b> <i>Only available on (2) arm</i>	\$65	<b>S2</b> Grade 2	\$160	<b>C2</b> Glides	\$25	<b>L13</b> 7" Dual Stage	\$55
<b>N</b>	<b>N-dulgent® Memory Foam</b>	\$75	<b>S3</b> Grade 3	\$200			<b>L14</b> 10" Dual Stage	\$55
<b>N2</b>	<b>ThermaGel Memory Foam</b>	\$90	<b>S4</b> Grade 4	\$240				
<b>S</b>	<b>Seat Slider</b>	\$75	<b>S5</b> Grade 5	\$280	<b>Bases</b>		<b>Connexion® Arm</b>	
			<b>SU</b> Stitched Ultraleather™	\$295	<b>B6</b> 26" Polished Aluminum	\$140	<b>Z1</b> Connexion Arm	\$350
			<b>S6</b> Grade 6	\$330			<i>Not available with (6) &amp; (7) arm</i>	
			<b>S7</b> Grade 7	\$380			<b>Connexion® Arm Attachments</b>	
			<b>S8</b> Grade 8	\$430			<b>A1</b> Tablet Holder	\$149
			<b>S9</b> Grade 9	\$480			<i>Requires (Z1) Connexion Arm</i>	
			<b>NR</b> Non-removable	\$0				
<b>Mesh Color</b>								
<b>M1</b>	<b>London (Navy)</b>	\$25						
<b>M2</b>	<b>Cognac (Red)</b>	\$25						
<b>M3</b>	<b>Mocha (Brown)</b>	\$25						
<b>M4</b>	<b>Ivory</b>	\$25						
<b>M5</b>	<b>Silver</b>	\$25						

# U4ia® Stool

Task/Conference

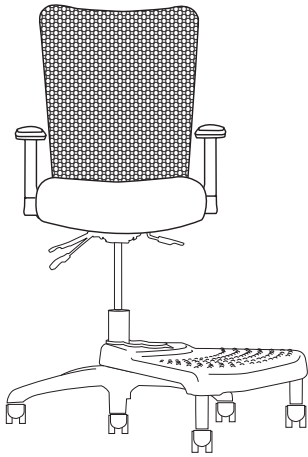

U4ia4608-R8

## Features

- Passive weight dispersion design
- Generous foam for optimal comfort
- Optional removable back sleeve for an upholstered look & feel

## Standard Features

- No Arms
- Carpet Casters
- 26" Black Base
- 8" Cylinder
- Black Mesh Back

## Need it Now? 5-day Quick Ship

Only standard features are available as Quick Ship unless otherwise noted.

### QUICK SHIP ARMS

3 3" Adjustable Arms

5 No Arms







9 5-way Adjustable Arms

### QUICK SHIP FABRICS

For available Quick Ship fabrics see page 8.

## Step 1 — Model Number

Series Code	Back	Select a Seat	Select an Arm	Select a Mech
U4ia U4ia	4 Mid Back	6 Medium Seat 7 Large Seat	0 4" Adjustable \$125 1 4" Adjustable w/Pivot \$150 2 Lateral Sliding \$140 3 3" Adjustable \$75 4 Swing \$295 5 No Arms \$0 6 C Loop \$75 7 Chrome Loop \$75 9 5-way Adjustable \$150	1 Basic 8 Standard 9 Deluxe-tilt
<b>U4ia</b>	<b>4</b>	<b>6</b>	<b>3</b>	<b>8</b>

Basic		Standard		Deluxe-tilt	
					
<b>U4ia4651</b>	<b>U4ia4751</b>	<b>U4ia4658</b>	<b>U4ia4758</b>	<b>U4ia4659</b>	<b>U4ia4759</b>
\$806	\$857	\$826	\$877	\$847	\$898
\$836	\$887	\$856	\$907	\$877	\$928
\$866	\$917	\$886	\$937	\$907	\$958
\$906	\$957	\$926	\$977	\$947	\$998
\$946	\$997	\$966	\$1,017	\$987	\$1,038
\$996	\$1,047	\$1,016	\$1,067	\$1,037	\$1,088
\$1,046	\$1,097	\$1,066	\$1,117	\$1,087	\$1,138
\$1,106	\$1,157	\$1,126	\$1,177	\$1,147	\$1,198
\$1,166	\$1,217	\$1,186	\$1,237	\$1,207	\$1,258

- Grade 1**
- Grade 2**
- Grade 3**
- Grade 4**
- Grade 5**
- Grade 6**
- Grade 7**
- Grade 8**
- Grade 9**

42.5 x 26 x 26	42.5 x 26 x 26	44.5 x 26 x 26	44.5 x 26 x 26	44.5 x 26 x 26	44.5 x 26 x 26	Chair (H x W x D)
32 lbs	32 lbs	40 lbs	40 lbs	40 lbs	40 lbs	Chair Weight
19.5	22	19.5	22	19.5	22	Seat Width
21.5 – 29.5	21.5 – 29.5	22.5 – 30.5	22.5 – 30.5	22.5 – 30.5	22.5 – 30.5	Seat Height
17 – 18	17 – 18	16.5 – 19	16.5 – 19	16.5 – 19	16.5 – 19	Seat Depth (OPTIONAL)
R4°	R4°	R3°	R3°	R4°	R4°	Seat Angle
19	19	19	19	19	19	Back Width
22	22	22	22	22	22	Back Height
97°	97°	95° – 102°	95° – 102°	95° – 102°	95° – 102°	Back Angle
N/A	N/A	N/A	N/A	N/A	N/A	Lumbar Range
26	26	26	26	26	26	Base Diameter
1 yd	1 yd	1 yd	1 yd	1 yd	1 yd	COM Yardage
36 x 26 x 19	36 x 26 x 19	36 x 26 x 19	36 x 26 x 19	36 x 26 x 19	36 x 26 x 19	Shipping Box (L x W x H)
42 lbs	42 lbs	50 lbs	50 lbs	50 lbs	50 lbs	Shipping Weight
KD	KD	KD	KD	KD	KD	Shipping Method

All measurements are nominal and shown in inches.

## Step 2 — Add option codes after model number U4ia4638 - \_ - \_

<b>General</b>		<b>Back Sleeve</b> (back of sleeve made w/Spacer)		<b>Bases</b>		<b>Connexion® Arm</b>		
<b>J</b>	<b>Upholstered Arm Pad</b> <i>Only available on (2) arm</i>	\$65	<b>S1</b> <b>Grade 1</b>	\$110	<b>B6</b> <b>26" Polished Aluminum</b>	\$140	<b>Z1</b> <b>Connexion Arm</b> <i>Not available with (6) &amp; (7) arm</i>	\$350
<b>N</b>	<b>N-dulgent® Memory Foam</b>	\$75	<b>S2</b> <b>Grade 2</b>	\$160	<b>Chair Cylinders</b>		<b>Connexion® Arm Attachments</b>	
<b>N2</b>	<b>ThermaGel Memory Foam</b>	\$90	<b>S3</b> <b>Grade 3</b>	\$200	<b>L1</b> <b>3" Cylinder</b>	\$0	<b>A1</b> <b>Tablet Holder</b>	\$149
<b>Mesh Color</b>			<b>S4</b> <b>Grade 4</b>	\$240	<b>L3</b> <b>5" Cylinder</b>	\$0	<i>Requires (Z1) Connexion Arm</i>	
<b>M1</b>	<b>London (Navy)</b>	\$25	<b>S5</b> <b>Grade 5</b>	\$280	<b>L13</b> <b>7" Dual Stage</b>	\$0	<b>NeXtep® for stool cylinders only</b>	
<b>M2</b>	<b>Cognac (Red)</b>	\$25	<b>SU</b> <b>Stitched Ultraleather™</b>	\$295	<b>L14</b> <b>10" Dual Stage</b>	\$0	<b>R8</b> <b>8" w/Casters</b>	\$185
<b>M3</b>	<b>Mocha (Brown)</b>	\$25	<b>S6</b> <b>Grade 6</b>	\$330	<b>Stool Cylinders</b>		<b>R10</b> <b>10" w/Casters</b>	\$185
<b>M4</b>	<b>Ivory</b>	\$25	<b>S7</b> <b>Grade 7</b>	\$380	<b>L5</b> <b>10" Cylinder</b>	\$0	<b>R18</b> <b>8"/10" w/Casters</b>	\$295
<b>M5</b>	<b>Silver</b>	\$25	<b>S8</b> <b>Grade 8</b>	\$430	<b>L7</b> <b>7" Cylinder</b>	\$0	<b>RW8</b> <b>Wide 8" w/Casters</b>	\$295
			<b>S9</b> <b>Grade 9</b>	\$480	<b>Footrings for stool cylinders only</b>		<b>RW10</b> <b>Wide 10" w/Casters</b>	\$295
			<b>NR</b> <b>Non-removable</b> <i>Make a back sleeve non-removable</i>	\$0	<b>R1</b> <b>18" Black Plastic</b>	\$60	<i>Also available w/glides.</i>	
			<b>Casters/Glides</b>		<b>R2</b> <b>20" Chrome</b>	\$80		
			<b>C1</b> <b>Hard Floor</b>	\$25				
			<b>C2</b> <b>Glides</b>	\$25				

For additional stool options see page 110.

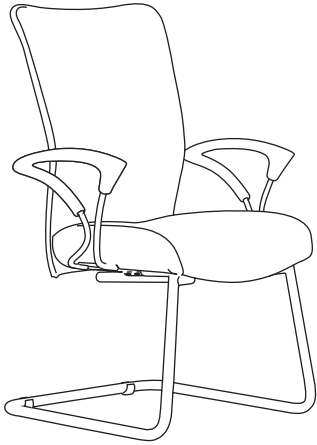

U4iaG4665



**Features**



- Mesh or upholstered back option
- Passive weight dispersion design
- Generous foam for optimal comfort
- Optional removable back sleeve for an upholstered look & feel

**Standard Features**

- No Arms
- Black Base

**Step 1 — Model Number**

Series Code	Back	Seat	Select an Arm	Select a Base
U4iaG U4ia Guest	4 Mid Back	6 Medium Seat	3 3" Adjustable <i>Fixe Width</i> \$75 5 No Arms \$0 6 C Loop \$75 7 Chrome Loop \$75	4 4-leg  5 Sled 
<b>U4iaG</b>	<b>4</b>	<b>6</b>	<b>3</b>	<b>5</b>

4-leg Base	Sled Base	
		
<b>U4iaG4654</b>	<b>U4iaG4655</b>	
\$729	\$796	<b>Grade 1</b>
\$759	\$826	<b>Grade 2</b>
\$789	\$856	<b>Grade 3</b>
\$829	\$896	<b>Grade 4</b>
\$869	\$936	<b>Grade 5</b>
\$919	\$986	<b>Grade 6</b>
\$969	\$1,036	<b>Grade 7</b>
\$1,029	\$1,096	<b>Grade 8</b>
\$1,089	\$1,156	<b>Grade 9</b>

38.75 x 20.5 x 24	38.25 x 20.5 x 24	Chair (H x W x D)
27.5 lbs	31 lbs	Chair Weight
19.5	19.5	Seat Width
18	17.25	Seat Height
18	18	Seat Depth
R3°	R4°	Seat Angle
19	19	Back Width
21	21	Back Height
104°	104°	Back Angle
N/A	N/A	Lumbar Range
20.5	20.5 x 23	Base Diameter
1 yd	1 yd	COM Yardage
30 x 27 x 39	30 x 27 x 39	Shipping Box (L x W x H)
37.5 lbs	40.5 lbs	Shipping Weight
FA	FA	Shipping Method

All measurements are nominal and shown in inches.

**Step 2** — Add option codes after model number U4iaG4635 - \_\_ - \_\_

General	Mesh Color	Back Sleeve (back of sleeve made w/Spacer)
<b>CB</b> Chrome Base \$95	<b>M0</b> Black Blurr \$0	<b>S1</b> Grade 1 \$110
	<b>M1</b> London (Navy) \$25	<b>S2</b> Grade 2 \$160
	<b>M2</b> Cognac (Red) \$25	<b>S3</b> Grade 3 \$200
	<b>M3</b> Mocha (Brown) \$25	<b>S4</b> Grade 4 \$240
	<b>M4</b> Ivory \$25	<b>S5</b> Grade 5 \$280
	<b>M5</b> Silver \$25	<b>SU</b> Stitched Ultraleather™ \$295
		<b>S6</b> Grade 6 \$330
		<b>S7</b> Grade 7 \$380
		<b>S8</b> Grade 8 \$430
		<b>S9</b> Grade 9 \$480
		<b>NR</b> Non-removable \$0



ULU4602

Task/Conference

**Features**

- Upholstered or mesh back
- Adjustable lumbar support (easily slide up & down with no levers)
- Weight sensing mechanism without tension knob
- Intuitive ergonomics

**Standard Features**

- No Arms
- Carpet Casters
- 25" Black Base
- 5" Cylinder
- Seat Slider
- Black Mesh
- Adjustable Lumbar

**Need it Now? 5-day Quick Ship**

**QS** Denotes Quick Ship models.

Only standard features are available as Quick Ship unless otherwise noted.



**QUICK SHIP ARMS**









- 3 3D
- 5 No Arms

**QUICK SHIP FABRICS**

For available Quick Ship fabrics see page 8.

**Step 1 — Model Number**

Series Code	Select a Back	Select a Seat	Select an Arm	Select a Mech
<b>ULU</b> Ulius	4 Mesh Back 5 Upholstered Back	6 Medium Seat 7 Large Seat	0 Fixed \$75 3 3D \$75 4 4D \$150 5 No Arms \$0 6 3D Chrome \$175 7 Chrome Loop \$295 8 4D Chrome \$250	2 <b>Synchro</b>  3 <b>Weight Sensitive</b> 
<b>ULU</b>	<b>4</b>	<b>6</b>	<b>3</b>	<b>3</b>

Synchro				Weight Sensitive				
								
ULU4652	ULU4752	ULU5652	ULU5752	ULU4653	ULU4753	ULU5653	ULU5753	
\$785	\$835	\$885	\$935	\$745	\$795	\$845	\$895	<b>Grade 1</b>
\$815	\$865	\$945	\$995	\$775	\$825	\$905	\$955	<b>Grade 2</b>
\$845	\$895	\$1,005	\$1,055	\$805	\$855	\$965	\$1,015	<b>Grade 3</b>
\$885	\$935	\$1,075	\$1,125	\$845	\$895	\$1,035	\$1,085	<b>Grade 4</b>
\$925	\$975	\$1,145	\$1,195	\$885	\$935	\$1,105	\$1,155	<b>Grade 5</b>
\$975	\$1,025	\$1,225	\$1,275	\$935	\$985	\$1,185	\$1,235	<b>Grade 6</b>
\$1,025	\$1,075	\$1,305	\$1,355	\$985	\$1,035	\$1,265	\$1,315	<b>Grade 7</b>
\$1,085	\$1,135	\$1,395	\$1,445	\$1,045	\$1,095	\$1,355	\$1,405	<b>Grade 8</b>
\$1,145	\$1,195	\$1,485	\$1,535	\$1,105	\$1,155	\$1,445	\$1,495	<b>Grade 9</b>
40 x 26 x 26	40 x 26 x 26	40 x 26 x 26	40 x 26 x 26	40 x 26 x 26	40 x 26 x 26	40 x 26 x 26	40 x 26 x 26	Chair (H x W x D)
30 lbs	30 lbs	30 lbs	30 lbs	28 lbs	28 lbs	28 lbs	28 lbs	Chair Weight
19.5	21	19.5	21	19.5	21	19.5	21	Seat Width
17.25 - 22.25	17.25 - 22.25	17.25 - 22.25	17.25 - 22.25	17 - 22	17 - 22	17 - 22	17 - 22	Seat Height
17.25 - 19.75	17.25 - 19.75	17 - 19.5	17 - 19.5	17.25 - 19.75	17.25 - 19.75	17 - 19.5	17 - 19.5	Seat Depth
R1.5° - R6°	R1.5° - R6°	R1.5° - R6°	R1.5° - R6°	R1° - R5.5°	R1° - R5.5°	R1° - R5.5°	R1° - R5.5°	Seat Angle
18.5	18.5	18.5	18.5	18.5	18.5	18.5	18.5	Back Width
22	22	22	22	22	22	22	22	Back Height
98° - 120°	98° - 120°	98° - 120°	98° - 120°	100° - 118°	100° - 118°	100° - 118°	100° - 118°	Back Angle
4.25 - 8.25	4.25 - 8.25	5 - 8	5 - 8	4.25 - 8.25	4.25 - 8.25	5 - 8	5 - 8	Lumbar Range
26	26	26	26	26	26	26	26	Base Diameter
1	1	3	3	1	1	3	3	COM Yardage
26 x 35.5 x 19	26 x 35.5 x 19	26 x 35.5 x 19	26 x 35.5 x 19	26 x 35.5 x 19	26 x 35.5 x 19	26 x 35.5 x 19	26 x 35.5 x 19	Shipping Box (L x W x H)
40 lbs	40 lbs	40 lbs	40 lbs	38 lbs	38 lbs	38 lbs	38 lbs	Shipping Weight
KD	KD	KD	KD	KD	KD	KD	KD	Shipping Method

All measurements are nominal and shown in inches.

**Step 2 — Add option codes after model number ULU4633 - \_ - \_**

General		Mesh Color		Casters		Cylinders		
<b>N</b>	N-dulgent® Memory Foam	\$75	<b>M1</b> Navy	\$50	<b>C1</b> Hard Floor	\$25	<b>L26</b> 5" Chrome Cylinder	\$55
<b>N2</b>	ThermaGel Memory Foam	\$90	<b>M3</b> Beige	\$50				
			<b>M5</b> Silver	\$50				
					Bases		Headrest	
					<b>B36</b> 25" Polished Aluminum	\$140	<b>H</b> Headrest	\$95

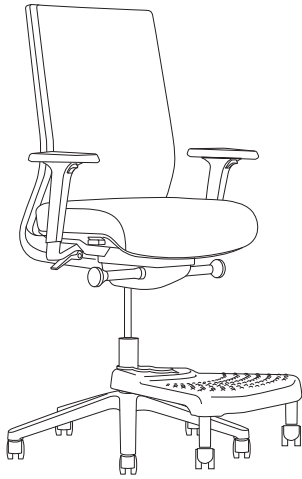

ULS5632

Task/Conference



**Features**

- Upholstered back
- Adjustable lumbar support (easily slide up & down with no levers)
- Weight sensing mechanism without tension knob
- Intuitive ergonomics

**Standard Features**

- No Arms
- Carpet Casters
- 26" Black Base
- 8" Cylinder
- Adjustable Lumbar

**Step 1 — Model Number**

Series Code	Select a Back	Select a Seat	Select an Arm	Select a Mech
<b>ULS</b> Ulius Stool	<b>5</b> Upholstered Back	<b>6</b> Medium Seat <b>7</b> Large Seat	<b>0</b> Fixed \$75 <b>3</b> 3D \$75 <b>4</b> 4D \$150 <b>5</b> No Arms \$0 <b>6</b> 3D Chrome \$175 <b>7</b> Chrome Loop \$295 <b>8</b> 4D Chrome \$250	<b>2</b> Synchro  <b>3</b> Weight Sensitive 
<b>ULS</b>	<b>5</b>	<b>6</b>	<b>3</b>	<b>3</b>

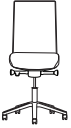
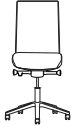
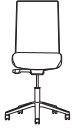
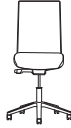

Synchro		Weight Sensitive	
			
<b>ULS5652</b>	<b>ULS5752</b>	<b>ULS5653</b>	<b>ULS5753</b>
\$885	\$935	\$845	\$895
\$945	\$995	\$905	\$955
\$1,005	\$1,055	\$965	\$1,015
\$1,075	\$1,125	\$1,035	\$1,085
\$1,145	\$1,195	\$1,105	\$1,155
\$1,225	\$1,275	\$1,185	\$1,235
\$1,305	\$1,355	\$1,265	\$1,315
\$1,395	\$1,445	\$1,355	\$1,405
\$1,485	\$1,535	\$1,445	\$1,495

- Grade 1**
- Grade 2**
- Grade 3**
- Grade 4**
- Grade 5**
- Grade 6**
- Grade 7**
- Grade 8**
- Grade 9**

46.25 x 26 x 26	46.25 x 26 x 26	46 x 26 x 26	46 x 26 x 26	Chair (H x W x D)
30 lbs	30 lbs	28 lbs	28 lbs	Chair Weight
19.5	21	19.5	21	Seat Width
23.25 - 31	23.25 - 31	23 - 30.75	23 - 30.75	Seat Height
17	17	17	17	Seat Depth
R1.5° - R6°	R1.5° - R6°	R1° - R5.5°	R1° - R5.5°	Seat Angle
18.5	18.5	18.5	18.5	Back Width
22	22	22	22	Back Height
98° - 120°	98° - 120°	100° - 118°	100° - 118°	Back Angle
5 - 8	5 - 8	5 - 8	5 - 8	Lumbar Range
26	26	26	26	Base Diameter
3	3	3	3	COM Yardage
26 x 35.5 x 19	26 x 35.5 x 19	26 x 35.5 x 19	26 x 35.5 x 19	Shipping Box (L x W x H)
41 lbs	41 lbs	39 lbs	39 lbs	Shipping Weight
KD	KD	KD	KD	Shipping Method

All measurements are nominal and shown in inches.

**Step 2 — Add option codes after model number ULU5633 - \_ - \_**

General	Cylinders	Footrings	NeXtep® for stool cylinders only
<b>N</b> N-dulgent® Memory Foam \$75	<b>L5</b> 10" Cylinder \$0	<b>R1</b> 18" Black Plastic \$60	<b>R8</b> 8" w/Casters \$185
<b>N2</b> ThermaGel Memory Foam \$90	<b>L7</b> 7" Cylinder \$0	<b>R2</b> 20" Chrome \$80	<b>R10</b> 10" w/Casters \$185
<b>Casters</b>	<b>L13</b> 7" Dual Stage \$0		<b>R18</b> 8"/10" w/Casters \$295
<b>C1</b> Hard Floor \$25	<b>L14</b> 10" Dual Stage \$0		<b>RW8</b> Wide 8" w/Casters \$295
<b>Bases</b>	<b>Headrest</b>		<b>RW10</b> Wide 10" w/Casters \$295
<b>B26</b> 25" Black \$0	<b>H</b> Headrest \$95		Also available w/glides.
<b>B36</b> 25" Polished Aluminum \$140			

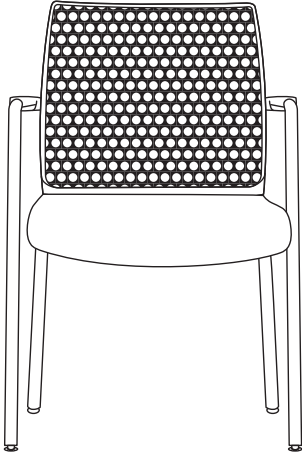

ULG264

Task/Conference

**Features**

- Upholstered and mesh back options
- Wall saver legs

**Standard Features**

- Black Base

**Step 1 — Model Number**

Series Code	Select a Back	Select a Seat	Select a Base
<p><b>ULG</b> Ulius Guest</p>	<p><b>2</b> Mesh Back</p> <p><b>3</b> Upholstered</p>	<p><b>6</b> Medium Seat</p>	<p><b>4</b> 4-leg</p>
<p><b>ULG</b></p>	<p><b>2</b></p>	<p><b>6</b></p>	<p><b>4</b></p>



ULG264



ULG364

\$635	\$735	<b>Grade 1</b>
\$665	\$795	<b>Grade 2</b>
\$695	\$855	<b>Grade 3</b>
\$735	\$925	<b>Grade 4</b>
\$775	\$995	<b>Grade 5</b>
\$825	\$1,075	<b>Grade 6</b>
\$875	\$1,155	<b>Grade 7</b>
\$935	\$1,245	<b>Grade 8</b>
\$995	\$1,335	<b>Grade 9</b>

33.25 x 21.5 x 24.5	33.25 x 21.5 x 24.5	Chair (H x W x D)
22 lbs	22 lbs	Chair Weight
19	19	Seat Width
17.5	17.5	Seat Height
19	19	Seat Depth
18	18	Back Width
16	16	Back Height
8.5	8.5	Arm Height
21.5	21.5	Arm Width
1	2	COM Yardage
24 x 23 x 35	24 x 23 x 35	Shipping Box (L x W x H)
32 lbs	32 lbs	Shipping Weight
FA	FA	Shipping Method

All measurements are nominal and shown in inches.

## Step 2 — Add option codes after model number ULG264 - \_\_ - \_\_

### General

**CB** Chrome Base \$95

---

## **ACTIVE/GUEST SEATING**

---

Neutral Posture's active/guest seating are ideal for high traffic areas like waiting rooms, cafes or multi-purpose spaces. Whether you're looking

for traditional guest chairs or seating for your collaborative areas, they provide support, comfort and style sure to bring sophistication to any area.

# ACTIVE/GUEST SEATING

---

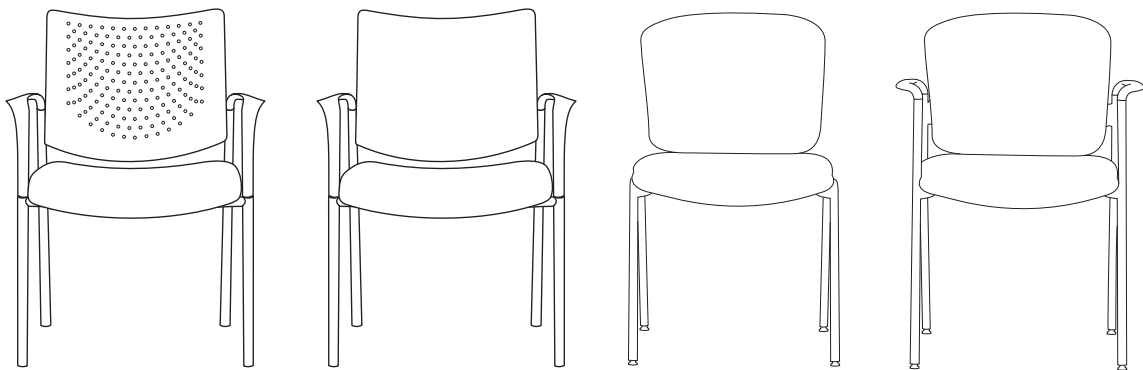

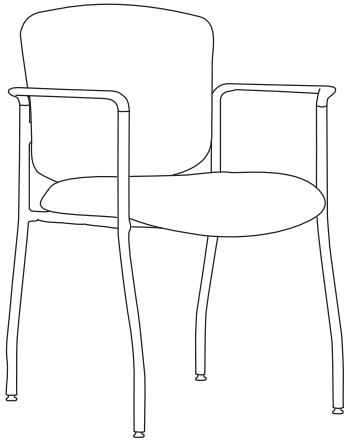

DCE211

Active/Guest

**Features**

- Stackable, up to 5 high
- Generous amount of foam in seat & back
- Fully upholstered back
- Self-leveling non-marking glides
- Optional arms
- Optional ganging device

**Standard Features**

- Black Base
- Glides

**Step 1 — Model Number**

Series Code	Back	Seat	Select an Arm
DCE Dice	2 Back	1 Seat	1 Arms 5 No Arms
DCE	2	1	1

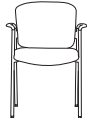
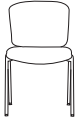

DCE215

DCE211

\$469	\$500	<b>Grade 1</b>
\$514	\$545	<b>Grade 2</b>
\$559	\$590	<b>Grade 3</b>
\$614	\$645	<b>Grade 4</b>
\$669	\$700	<b>Grade 5</b>
\$734	\$765	<b>Grade 6</b>
\$799	\$830	<b>Grade 7</b>
\$874	\$905	<b>Grade 8</b>
\$949	\$980	<b>Grade 9</b>

33 x 19 x 21.5	33 x 23.5 x 21.5	Chair (H x W x D)
19 lbs	20 lbs	Chair Weight
18	18	Seat Width
18.5	18.5	Seat Height
18	18	Seat Depth
19	19	Back Width
15.5	15.5	Back Height
N/A	21	Arm Width
2 yd	2 yd	COM Yardage
24 x 23 x 35	24 x 23 x 35	Shipping Box (L x W x H)
29 lbs	30 lbs	Shipping Weight
FA	FA	Shipping Method

All measurements are nominal and shown in inches.

**Step 2** — Add option codes after model number DCE211 - \_\_ - \_\_

**General**

<b>C6</b>	<b>Optional Casters</b> <i>Set of 4</i>	<b>\$30</b>
<b>CBL005</b>	<b>Ganging Device</b> <i>2 per set</i>	<b>\$30</b>
<b>CP</b>	<b>Chrome Package</b> <i>Chrome frame</i>	<b>\$40</b>

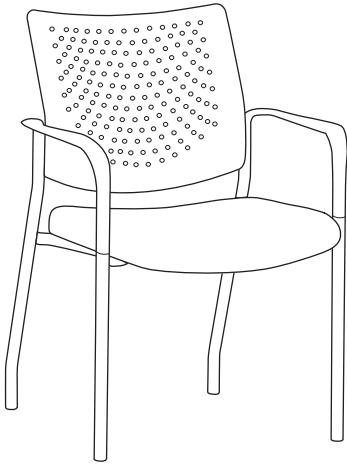

**FAC160**  
Molded plastic back

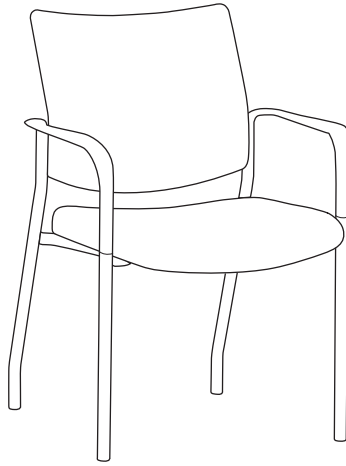

**FAC260**  
Upholstered back

**Features**

- 9 frame colors available in addition to standard black
- Upholstered or molded plastic back
- Upholstered back style stacks 5-high
- Molded plastic back style stacks 6-high
- Integrated wall saver leg design
- Optional ganging device
- Optional arms

**Standard Features**

- Black Base
- Glides

**Step 1 — Model Number**

Series Code

**FAC** Facet

**FAC**

Select a Back

- 1** Molded Plastic Back
- 2** Upholstered Back

**1**

Seat

**6** Medium Seat

**6**

Select an Arm

- 0** Arms
- 5** No Arms

**0**



Molded Plastic Back

Upholstered Back

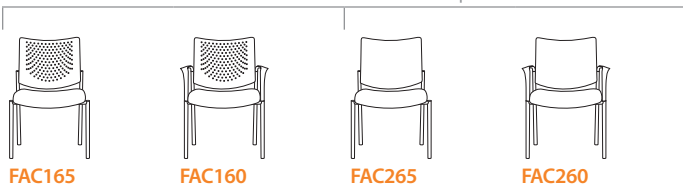

FAC165	FAC160	FAC265	FAC260
\$392	\$414	\$434	\$457
\$437	\$459	\$479	\$502
\$482	\$504	\$524	\$547
\$537	\$559	\$579	\$602
\$592	\$614	\$634	\$657
\$657	\$679	\$699	\$722
\$722	\$744	\$764	\$787
\$797	\$819	\$839	\$862
\$872	\$894	\$914	\$937

- Grade 1
- Grade 2
- Grade 3
- Grade 4
- Grade 5
- Grade 6
- Grade 7
- Grade 8
- Grade 9

33 x 22.5 x 23	33 x 24.5 x 23	33 x 22.5 x 23	33 x 24.5 x 23
16.5 lbs	18 lbs	18.5 lbs	20 lbs
18.5	18.5	18.5	18.5
18.5	18.5	18.5	18.5
18.5	18.5	18.5	18.5
18.5	18.5	18.5	18.5
15	15	15	15
N/A	24.5	N/A	24.5
0.75 yd	0.75 yd	1.25 yd	1.25 yd
29 x 27 x 39	29 x 27 x 39	29 x 27 x 39	29 x 27 x 39
26.5 lbs	28 lbs	28.5 lbs	30 lbs
FA	FA	FA	FA

- Chair (H x W x D)
- Chair Weight
- Seat Width
- Seat Height
- Seat Depth
- Back Width
- Back Height
- Arm Width
- COM Yardage
- Shipping Box (L x W x H)
- Shipping Weight
- Shipping Method

All measurements are nominal and shown in inches.

Active/Guest

**Step 2** — Add option codes after model number FAC160 - \_\_ - \_\_

General		Frame Color	
<b>C6</b>	<b>Casters</b> <i>Set of 4</i>	<b>\$30</b>	<b>201T Cream</b> \$120
<b>CBL005</b>	<b>Ganging Device</b> <i>2 per set</i>	<b>\$30</b>	<b>202T Designer Beige</b> \$120
			<b>203T Grey</b> \$120
			<b>204T Jet Black</b> \$120
			<b>200T Sky White</b> \$120
			<b>303 Brass</b> \$140
			<b>301 Champagne</b> \$140
			<b>302 Platinum</b> \$140

---

## INDUSTRIAL/HEALTHCARE SEATING

---

Neutral Posture's industrial seating is designed for mobility and support during the busy workday. The industrial chairs were designed with a different mindset than most chairs because they serve such different and unique purposes. Industrial seating is designed to support some of the hardest workers out there. From the dental assistant on the Geo to the car mechanic on the Stratus Urethane, the Industrial seating plays an imperative role in the backbone of

almost every company. With an indefinite number of customization options in industrial seating, you can build and design the perfect industrial chair that will support you and work just as hard as you do. From the urethane seats that are stain resistant and can be used in the roughest environments to the upholstered Adapta Stool for more long term use, NP's industrial seating has everything you need to be supported and productive in your work.

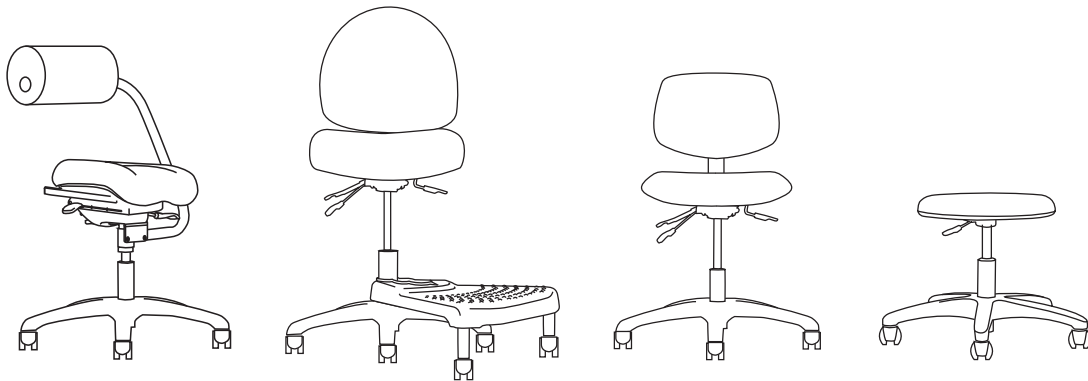

# INDUSTRIAL/HEALTHCARE SEATING

---

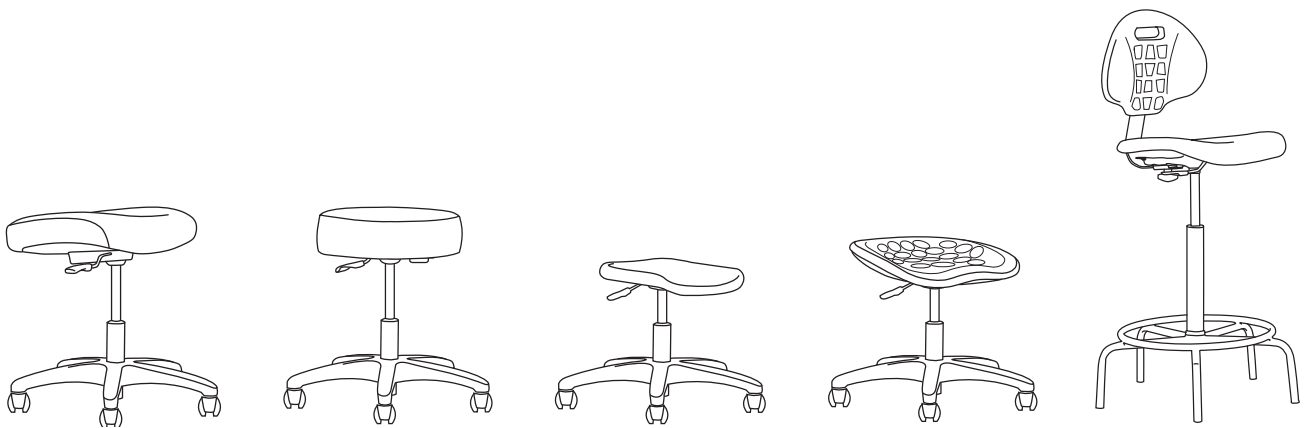

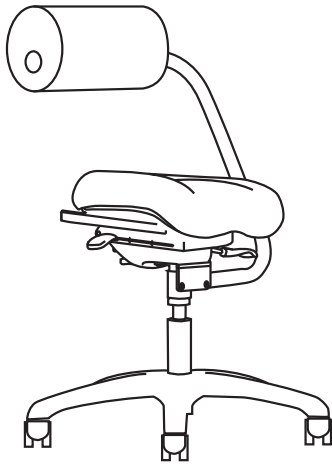

ABC1633

## Features

- ESD & Cleanroom options available
- Adjustable seat height, depth, angle & tension
- Adjustable AbRest™ height
- 4-way AbRest™ rotation
- AbRest™ swivel/pivot

## Standard Features

- Black Arm
- Hard Floor Casters
- 26" Black Base
- 5" Cylinder

## Step 1 — Model Number

Series Code	Select a Back	Select a Seat	Arm	Mech
ABC AbChair	1 Urethane AbRest 2 Upholstered AbRest	3 Medium Seat 5 Urethane Seat 6 Medium Seat <i>Moderate Contour</i>	3 Black Arm	3 Tilt <i>w/Seat Slider</i>
ABC	2	3	3	3

ABC1333	ABC1533	ABC1633	ABC2333	ABC2533	ABC2633
\$1,112	\$1,142	\$1,224	\$1,112	\$1,142	\$1,224
\$1,142	N/A	\$1,254	\$1,172	\$1,202	\$1,284
\$1,172	N/A	\$1,284	\$1,232	\$1,262	\$1,344
\$1,212	N/A	\$1,324	\$1,302	\$1,332	\$1,414
\$1,252	N/A	\$1,364	\$1,372	\$1,402	\$1,484
\$1,302	N/A	\$1,414	\$1,452	\$1,482	\$1,564
\$1,352	N/A	\$1,464	\$1,532	\$1,562	\$1,644
\$1,412	N/A	\$1,524	\$1,622	\$1,652	\$1,734
\$1,472	N/A	\$1,584	\$1,712	\$1,742	\$1,824
37 x 28 x 28	37 x 28 x 28	37 x 28 x 28	37 x 28 x 28	37 x 28 x 28	37 x 28 x 28
45 lbs	49 lbs	47 lbs	45 lbs	49 lbs	47 lbs
22	19	23	22	19	23
21 – 26	20 – 25	22 – 27	21 – 26	20 – 25	22 – 27
17 – 19.75	16 – 18.75	18 – 20.75	17 – 19.75	16 – 18.75	18 – 20.75
R1° – F16°	R1° – F16°	R1° – F16°	R1° – F16°	R1° – F16°	R1° – F16°
26	26	26	26	26	26
1 yd	N/A	1 yd	2 yd	1 yd	2 yd
36 x 26 x 19	36 x 26 x 19	36 x 26 x 19	36 x 26 x 19	36 x 26 x 19	36 x 26 x 19
55 lbs	59 lbs	57 lbs	55 lbs	59 lbs	57 lbs
FA	FA	FA	FA	FA	FA

- Grade 1
- Grade 2
- Grade 3
- Grade 4
- Grade 5
- Grade 6
- Grade 7
- Grade 8
- Grade 9

- Chair (H x W x D)
- Chair Weight
- Seat Width
- Seat Height
- Seat Depth
- Seat Angle
- Base Diameter
- COM Yardage
- Shipping Box (L x W x H)
- Shipping Weight
- Shipping Method

All measurements are nominal and shown in inches. Specs may differ for stools.

**Step 2 — Add option codes after model number ABC2333 - \_\_ - \_\_**

<b>General</b>	<b>Bases</b>
<b>CR Cleanroom to Class 100</b> \$120 <i>Urethane AbRest only</i>	<b>B0 26" Black</b> \$0
<b>E ESD*</b> \$290	<b>B9 28" Chrome</b> \$160
	<b>B22 22" Black</b> \$0
<b>Casters/Glides</b>	<b>Chair Cylinder</b>
<b>C1 Hard Floor</b> \$0	<b>L3 5" Cylinder</b> \$0
<b>C2 Glides</b> \$0	<b>L14 10" Dual Stage</b> \$55
<b>C3 Occupied Braking</b> \$185	
<b>C4 Unoccupied Braking</b> \$60	

**Stool Options**

<b>Stool Cylinder</b>	
<b>L4 8" Cylinder</b>	\$55
<b>Footrings for stool cylinders only</b>	
<b>R1 18" Black Plastic</b>	\$60
<b>R2 20" Chrome</b>	\$80
<b>NeXtep® for stool cylinders only</b>	
<b>R8 8" w/Casters</b>	\$185
<b>R10 10" w/Casters</b>	\$185
<b>R18 8"/10" w/Casters</b>	\$295
<b>RW8 Wide 8" w/Casters</b>	\$295
<b>RW10 Wide 10" w/Casters</b>	\$295
Also available w/glides.	

For additional stool options see page 110.

# Adapta™ Stool

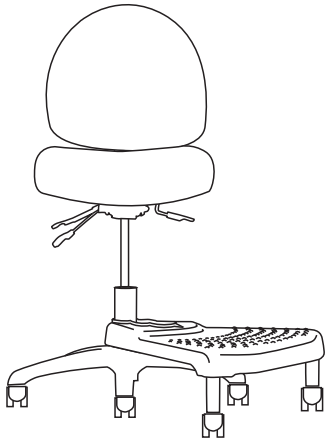

ADS5658-R8

## Features



- Upholstered seat & back
- Generous foam for optimal comfort
- ESD & Cleanroom options available
- Optional NeXtep® platform with depth adjustments







## Standard Features

- No Arms
- Hard Floor Casters
- 26" Black Base
- 8" Cylinder

Industrial/Healthcare

## Step 1 — Model Number

Series Code	Back	Select a Seat	Select an Arm	Select a Mech
<b>ADS</b> Adapta	<b>5</b> Mid Back	<b>6</b> Medium Seat <b>7</b> Large Seat	<b>0</b> 4" Adjustable \$125 <b>1</b> 4" Adjustable w/Pivot \$150 <b>2</b> Lateral Sliding \$140 <b>3</b> 3" Adjustable \$75 <b>4</b> Swing \$295 <b>5</b> No Arms \$0 <b>6</b> C Loop \$75 <b>7</b> Chrome Loop \$75 <b>9</b> 5-way Adjustable \$150	<b>1</b> Basic  <b>8</b> Standard  <b>9</b> Deluxe-tilt 
<b>ADS</b>	<b>5</b>	<b>6</b>	<b>3</b>	<b>8</b>

Basic		Standard		Deluxe-tilt	
					
<b>ADS5651</b>	<b>ADS5751</b>	<b>ADS5658</b>	<b>ADS5758</b>	<b>ADS5659</b>	<b>ADS5759</b>
\$836	\$887	\$857	\$908	\$877	\$928
\$896	\$947	\$917	\$968	\$937	\$988
\$956	\$1,007	\$977	\$1,028	\$997	\$1,048
\$1,026	\$1,077	\$1,047	\$1,098	\$1,067	\$1,118
\$1,096	\$1,147	\$1,117	\$1,168	\$1,137	\$1,188
\$1,176	\$1,227	\$1,197	\$1,248	\$1,217	\$1,268
\$1,256	\$1,307	\$1,277	\$1,328	\$1,297	\$1,348
\$1,346	\$1,397	\$1,367	\$1,418	\$1,387	\$1,438
\$1,436	\$1,487	\$1,457	\$1,508	\$1,477	\$1,528
42 x 26 x 26	42 x 26 x 26	43 x 26 x 26	43 x 26 x 26	43 x 26 x 26	43 x 26 x 26
32 lbs	32 lbs	40.5 lbs	40.5 lbs	40.5 lbs	40.5 lbs
19.5	22	19.5	22	19.5	22
21.5 – 29.5	21.5 – 29.5	22.5 – 30.5	22.5 – 30.5	22.5 – 30.5	22.5 – 30.5
14.5 – 16	14.5 – 16	15 – 17.5	15 – 17.5	15 – 17.5	15 – 17.5
R4°	R4°	R3°	R3°	R4°	R4°
19.5	19.5	19.5	19.5	19.5	19.5
20.5	20.5	21 – 23.5	21 – 23.5	21 – 23.5	21 – 23.5
100°	100°	97° – 105°	97° – 105°	97° – 105°	97° – 105°
2.75	2.75	2.75	2.75	2.75	2.75
26	26	26	26	26	26
2 yd	2 yd	2 yd	2 yd	2 yd	2 yd
36 x 26 x 19	36 x 26 x 19	36 x 26 x 19	36 x 26 x 19	36 x 26 x 19	36 x 26 x 19
42 lbs	42 lbs	50.5 lbs	50.5 lbs	50.5 lbs	50.5 lbs
KD	KD	KD	KD	KD	KD

- Grade 1
- Grade 2
- Grade 3
- Grade 4
- Grade 5
- Grade 6
- Grade 7
- Grade 8
- Grade 9

- Chair (H x W x D)
- Chair Weight
- Seat Width
- Seat Height
- Seat Depth
- Seat Angle
- Back Width
- Back Height
- Back Angle
- Lumbar Range
- Base Diameter
- COM Yardage
- Shipping Box (L x W x H)
- Shipping Weight
- Shipping Method

All measurements are nominal and shown in inches.

## Step 2 — Add option codes after model number ADS5638 - \_\_ - \_\_

## Stool Options

### General

<b>CR</b>	<b>Cleanroom to Class 100</b>	<b>\$120</b>
<b>E</b>	<b>ESD*</b>	<b>\$290</b>
<b>F</b>	<b>Fring® Footrest</b>	<b>\$100</b>
	<i>Only available on (B0) base</i>	
<b>J</b>	<b>Upholstered Arm Pad</b>	<b>\$65</b>
	<i>Only available on (2) arm</i>	

### Casters/Glides

<b>C0</b>	<b>Carpet</b>	<b>\$0</b>
<b>C1</b>	<b>Hard Floor</b>	<b>\$0</b>
<b>C2</b>	<b>Glides</b>	<b>\$0</b>
<b>C3</b>	<b>Occupied Braking</b>	<b>\$185</b>
<b>C4</b>	<b>Unoccupied Braking</b>	<b>\$60</b>
<b>C5</b>	<b>Single Wheel Industrial</b>	<b>\$60</b>
	<i>Hard floor</i>	

### Bases

<b>B0</b>	<b>26" Black</b>	<b>\$0</b>
<b>B3</b>	<b>26" Spider Ring w/Glides</b>	<b>\$140</b>
	<i>Special shipping required</i>	
<b>B6</b>	<b>26" Polished Aluminum</b>	<b>\$140</b>
<b>B9</b>	<b>28" Chrome</b>	<b>\$160</b>
<b>B12</b>	<b>28" Black</b>	<b>\$110</b>
<b>B20</b>	<b>25" Spider Ring w/Glides</b>	<b>\$145</b>
	<i>Special shipping required</i>	

### Chair Cylinders

<b>L1</b>	<b>3" Cylinder</b>	<b>\$0</b>
<b>L3</b>	<b>5" Cylinder</b>	<b>\$0</b>
<b>L13</b>	<b>7" Dual Stage</b>	<b>\$55</b>
<b>L14</b>	<b>10" Dual Stage</b>	<b>\$55</b>

### Stool Cylinders

<b>L4</b>	<b>8" Cylinder</b>	<b>\$0</b>
<b>L5</b>	<b>10" Cylinder</b>	<b>\$0</b>
<b>L7</b>	<b>7" Cylinder</b>	<b>\$0</b>

### Footrings for stool cylinders only

<b>R1</b>	<b>18" Black Plastic</b>	<b>\$60</b>
<b>R2</b>	<b>20" Chrome</b>	<b>\$80</b>

### NeXtep® for stool cylinders only

<b>R8</b>	<b>8" w/Casters</b>	<b>\$185</b>
<b>R10</b>	<b>10" w/Casters</b>	<b>\$185</b>
<b>R18</b>	<b>8"/10" w/Casters</b>	<b>\$295</b>
<b>RW8</b>	<b>Wide 8" w/Casters</b>	<b>\$295</b>
<b>RW10</b>	<b>Wide 10" w/Casters</b>	<b>\$295</b>

Also available w/glides.

For additional stool options see page 110.

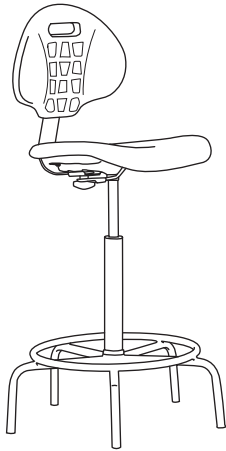

NCUGG1-L5-B20

Industrial/Healthcare

**Features**

- 3 active adjustments
- Concave low back
- Contoured, waterfall seat
- Textured urethane seat & back
- Wide variety of stool packages
- Urethane is resilient to harsh environments
- Cleanroom option available

**Standard Features**

- No Arms
- Hard Floor Casters
- 26" Black Base
- 5" Cylinder
- Cleanroom to Class 100

**Step 1 — Model Number**

Series Code	Back	Seat	Mech
NCU Geo	G Geo Urethane Back	G Geo Urethane Seat	1 Basic 
<b>NCU</b>	<b>G</b>	<b>G</b>	<b>1</b>





**NCUGG1**

\$367

**Urethane**

38 x 26 x 26	Chair (H x W x D)
22 lbs	Chair Weight
18	Seat Width
15.5 – 20.5	Seat Height
16.5 – 19	Seat Depth
R 9°	Seat Angle
16.25	Back Width
14.5 – 18	Back Height
95° – 100°	Back Angle
N/A	Lumbar Range
26	Base Diameter
30.25 x 26 x 24	Shipping Box (L x W x H)
32 lbs	Shipping Weight
KD	Shipping Method

All measurements are nominal and shown in inches.  
Specs may differ for stools.

**Step 2 — Add option codes after model number NCUGG1 - \_\_ - \_\_**

**Stool Options**

General		Bases		Chair Cylinders		Stool Cylinders					
<b>F</b>	<b>Fring® Footrest</b> <i>Only available on (B0) base</i>	<b>\$50</b>	<b>B0</b>	<b>26" Black</b>	<b>\$0</b>	<b>L1</b>	<b>3" Cylinder</b>	<b>\$0</b>	<b>L4</b>	<b>8" Cylinder</b>	<b>\$55</b>
			<b>B3</b>	<b>26" Spider Ring w/Glides</b> <i>Special shipping required</i>	<b>\$140</b>	<b>L3</b>	<b>5" Cylinder</b>	<b>\$0</b>	<b>L5</b>	<b>10" Cylinder</b>	<b>\$55</b>
			<b>B6</b>	<b>26" Polished Aluminum</b>	<b>\$140</b>	<b>L13</b>	<b>7" Dual Stage</b>	<b>\$55</b>	<b>L7</b>	<b>7" Cylinder</b>	<b>\$55</b>
			<b>B9</b>	<b>28" Chrome</b>	<b>\$160</b>	<b>L14</b>	<b>10" Dual Stage</b>	<b>\$55</b>			
			<b>B12</b>	<b>28" Black</b>	<b>\$110</b>				<b>Footrings for stool cylinders only</b>		
			<b>B20</b>	<b>25" Spider Ring w/Glides</b> <i>Special shipping required</i>	<b>\$145</b>				<b>R1</b>	<b>18" Black Plastic</b>	<b>\$60</b>
									<b>R2</b>	<b>20" Chrome</b>	<b>\$80</b>
									<b>NeXtep® for stool cylinders only</b>		
									<b>R8</b>	<b>8" w/Casters</b>	<b>\$185</b>
									<b>R10</b>	<b>10" w/Casters</b>	<b>\$185</b>
									<b>R18</b>	<b>8"/10" w/Casters</b>	<b>\$295</b>
									<b>RW8</b>	<b>Wide 8" w/Casters</b>	<b>\$295</b>
									<b>RW10</b>	<b>Wide 10" w/Casters</b>	<b>\$295</b>

Also available w/glides.

For additional stool options see page 110.

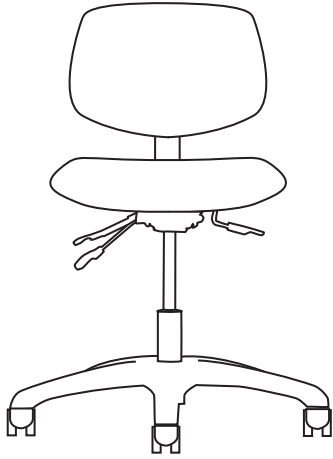

NCU552

Industrial/Healthcare



## Features

- Passive weight dispersion design
- Urethane is resilient to harsh environments
- Wide variety of stool options
- Cleanroom option available

## Standard Features

- No Arms
- Hard Floor Casters
- 26" Black Base
- 5" Cylinder
- Cleanroom to Class 100

## Step 1 — Model Number

Series Code	Back	Seat	Select a Mech
NCU Graphite	5 Flat Urethane Back	5 Flat Urethane Seat	1 Basic  2 Standard  3 Deluxe-tilt 
<b>NCU</b>	<b>5</b>	<b>5</b>	<b>2</b>

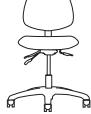
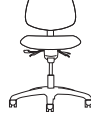
Basic	Standard	Deluxe-tilt
		
<b>NCU551</b>	<b>NCU552</b>	<b>NCU553</b>
\$479	\$541	\$571

**Urethane**

	Basic	Standard	Deluxe-tilt	
	33.5 x 26 x 26	31.5 x 26 x 26	31.5 x 26 x 26	Chair (H x W x D)
	41 lbs	41 lbs	41 lbs	Chair Weight
	19	19	19	Seat Width
	14.25 – 19.25	14 – 19	14 – 19	Seat Height
	17.5 – 20	18	18	Seat Depth
	R5°	R5°	F7° – R4°	Seat Angle
	17	17	17	Back Width
	16.25	14.5 – 18.5	14.5 – 18.5	Back Height
	103°	90° – 120°	105° – 136°	Back Angle
	16 – 20	16 – 20	16 – 20	Lumbar Range
	26	26	26	Base Diameter
	28 x 26 x 24	28 x 26 x 24	28 x 26 x 24	Shipping Box (L x W x H)
	51 lbs	51 lbs	51 lbs	Shipping Weight
	KD	KD	KD	Shipping Method

All measurements are nominal and shown in inches. Specs may differ for stools.

**Step 2 — Add option codes after model number NCU552 - \_\_\_ - \_\_\_**

**Stool Options**

General		Casters/Glides		Bases		Stool Cylinders			
<b>F</b>	<b>Fring® Footrest</b> <i>Only available on (B0) base</i>	\$50	<b>C2</b>	<b>Glides</b>	\$0	<b>L4</b>	<b>8" Cylinder</b>	\$55	
<b>HD</b>	<b>Heavy Duty</b> <i>Only available on (1) Mech</i>	\$100	<b>C3</b>	<b>Occupied Braking</b>	\$185	<b>L5</b>	<b>10" Cylinder</b>	\$55	
			<b>C4</b>	<b>Unoccupied Braking</b>	\$60	<b>L7</b>	<b>7" Cylinder</b>	\$55	
<b>Arms</b>				<b>B3</b>	<b>26" Spider Ring w/Glides</b> <i>Special shipping required</i>	\$140	<b>Footrings for stool cylinders only</b>		
<b>A0</b>	<b>4" Adjustable</b>	\$140		<b>B6</b>	<b>26" Polished Aluminum</b>	\$140	<b>R1</b>	<b>18" Black Plastic</b>	\$60
<b>A2</b>	<b>T Arms</b>	\$90		<b>B9</b>	<b>28" Chrome</b>	\$160	<b>R2</b>	<b>20" Chrome</b>	\$80
<b>A3</b>	<b>3" Adjustable</b>	\$90		<b>B12</b>	<b>28" Black</b>	\$110	<b>NeXtep® for stool cylinders only</b>		
<b>A6</b>	<b>4" Adjustable Extended Height</b>	\$190		<b>B20</b>	<b>25" Spider Ring w/Glides</b> <i>Special shipping required</i>	\$145	<b>R8</b>	<b>8" w/Casters</b>	\$185
							<b>R10</b>	<b>10" w/Casters</b>	\$185
							<b>R18</b>	<b>8"/10" w/Casters</b>	\$295
							<b>RW8</b>	<b>Wide 8" w/Casters</b>	\$295
							<b>RW10</b>	<b>Wide 10" w/Casters</b>	\$295

Also available w/glides.

For additional stool options see page 110.

# Stratus™ Upholstered

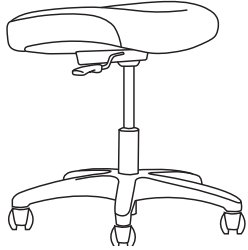

NBF064



NBF074

## Features

- ESD & Cleanroom options available
- Passive weight dispersion design
- Generous foam for optimal comfort





## Standard Features

- Hard Floor Casters
- 22" Black Base
- 5" Cylinder

Industrial/Healthcare

## Step 1 — Model Number

Series Code	Back	Select a Seat	Select a Mech
NBF Stratus Upholstered	0 Backless	6 Medium Seat 7 Round Seat	4 Basic 5 Ring 6 Tilt
<b>NBF</b>	<b>0</b>	<b>6</b>	<b>6</b> 

Basic	Ring	Tilt	
			
<b>NBF064</b>	<b>NBF074</b>	<b>NBF075</b>	<b>NBF066</b>
\$316	\$265	\$296	\$418
\$346	\$295	\$326	\$448
\$376	\$325	\$356	\$478
\$416	\$365	\$396	\$518
\$456	\$405	\$436	\$558
\$506	\$455	\$486	\$608
\$556	\$505	\$536	\$658
\$616	\$565	\$596	\$718
\$676	\$625	\$656	\$778

- Grade 1
- Grade 2
- Grade 3
- Grade 4
- Grade 5
- Grade 6
- Grade 7
- Grade 8
- Grade 9

17 x 22 x 22	16 x 22 x 22	16 x 22 x 22	19 x 22 x 22	Chair (H x W x D)
16.5 lbs	14 lbs	14 lbs	23.5 lbs	Chair Weight
19.5	16	16	19.5	Seat Width
14.5 – 19.5	16 – 21	16 – 21	15.75 – 20.75	Seat Height
18.5	16	16	18.5	Seat Depth
F4.4°	N/A	N/A	F4.7° – R21.3°	Seat Angle
22	22	22	22	Base Diameter
1 yd	1 yd	1 yd	1 yd	COM Yardage
28 x 26 x 24	25 x 25 x 11	25 x 25 x 11	28 x 26 x 24	Shipping Box (L x W x H)
26.5 lbs	24 lbs	24 lbs	33.5 lbs	Shipping Weight
KD	KD	KD	KD	Shipping Method

All measurements are nominal and shown in inches.  
Specs may differ for stools.

## Step 2 — Add option codes after model number NBF066 - \_\_ - \_\_

## Stool Options

<b>General</b>	<b>Bases</b>	<b>Connexion® Arm</b>	<b>Stool Cylinders</b>
<b>CR Cleanroom to Class 100</b> \$120	<b>B0 26" Black</b> \$0	<b>Z1 Connexion Arm</b> \$350	<b>L4 8" Cylinder</b> \$55
<b>E ESD*</b> \$290	<b>B3 26" Spider Ring w/Glides</b> \$140 <i>Special shipping required</i>	<i>Only available on (7) seat</i>	<b>L5 10" Cylinder</b> \$55
<b>F Fring® Footrest</b> \$50 <i>Only available on (B0) base</i>	<b>B6 26" Polished Aluminum</b> \$140	<b>Connexion® Arm Attachments</b>	<b>L7 7" Cylinder</b> \$55
<b>Casters/Glides</b>	<b>B9 28" Chrome</b> \$160	<b>A1 Tablet Holder</b> \$149 <i>Requires (Z1) Connexion Arm</i>	<b>Footrings for stool cylinders only</b>
<b>C1 Hard Floor</b> \$0	<b>B12 28" Black</b> \$110		<b>R1 18" Black Plastic</b> \$60
<b>C2 Glides</b> \$0	<b>B20 25" Spider Ring w/Glides</b> \$145 <i>Special shipping required</i>		<b>R2 20" Chrome</b> \$80
<b>C3 Occupied Braking</b> \$185	<b>B22 22" Black</b> \$0		<b>NeXtep® for stool cylinders only</b>
<b>C4 Unoccupied Braking</b> \$60	<b>Chair Cylinders</b>		<b>R8 8" w/Casters</b> \$185
<b>C5 Single Wheel Industrial</b> \$60 <i>Hard floor</i>	<b>L1 3" Cylinder</b> \$0		<b>R10 10" w/Casters</b> \$185
	<b>L3 5" Cylinder</b> \$0		<b>R18 8"/10" w/Casters</b> \$295
	<b>L14 10" Dual Stage</b> \$55		<b>RW8 Wide 8" w/Casters</b> \$295
			<b>RW10 Wide 10" w/Casters</b> \$295

Also available w/glides.

For additional stool options see page 110.

\*Contact Customer Service – customerservice@neutralposture.com

# Stratus™ Urethane

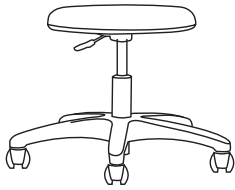

NBU044

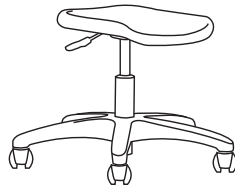

NBU054

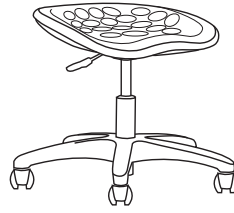

NBU084

## Features



- Passive weight dispersion design
- Urethane is resilient to harsh environments
- Cleanroom option available

## Standard Features

- 5" Cylinder
- 22" Black Base
- Hard Floor Casters
- Cleanroom to Class 100

Industrial/Healthcare

## Step 1 — Model Number







Series Code	Back	Select a Seat	Select a Mech
NBU Stratus Urethane	0 Backless	4 Round Seat 5 Flat Seat 8 Tractor Seat	4 Basic  5 Ring  6 Tilt 
<b>NBU</b>	<b>0</b>	<b>4</b>	<b>6</b>

Basic

Ring

Tilt

## Stratus™ Urethane

Basic		Ring		Tilt	
					
<b>NBU044</b>	<b>NBU054</b>	<b>NBU084</b>	<b>NBU045</b>	<b>NBU056</b>	<b>NBU086</b>
\$204	\$326	\$357	\$235	\$428	\$459
13.5 x 22 x 22	14.5 x 22 x 22	13.5 x 22 x 22	13.5 x 22 x 22	15 x 22 x 22	13.25 x 22 x 22
17 lbs	28 lbs	22 lbs	17 lbs	28 lbs	22 lbs
14	19	19	14	19	19
13.5 – 18.5	14.5 – 19.5	13.5 – 18.5	13.5 – 18.5	15 – 20	13.25 – 18.25
14	18	13.5	14	18	13.5
R0°	R7°	R2.5°	R0°	F2° – R14°	F2.5° – R10°
22	22	22	22	22	22
N/A	N/A	N/A	N/A	N/A	N/A
25 x 25 x 11	25 x 25 x 11	25 x 25 x 11	25 x 25 x 11	25 x 25 x 11	25 x 25 x 11
27 lbs	38 lbs	32 lbs	27 lbs	38 lbs	32 lbs
KD	KD	KD	KD	KD	KD

## Urethane

Chair (H x W x D)

Chair Weight

Seat Width

Seat Height

Seat Depth

Seat Angle

Base Diameter

COM Yardage

Shipping Box (L x W x H)

Shipping Weight

Shipping Method

All measurements are nominal and shown in inches.  
Specs may differ for stools.

## Step 2 — Add option codes after model number NBU046 - \_\_\_ - \_\_\_

## Stool Options

## General

**F** **Fring® Footrest** \$50  
*Only available on (B0) base*

## Casters/Glides

**C1** **Hard Floor** \$0  
**C2** **Glides** \$0  
**C3** **Occupied Braking** \$185  
**C4** **Unoccupied Braking** \$60  
**C5** **Single Wheel Industrial** \$60  
*Hard floor*

## Bases

**B0** **26" Black** \$0  
**B3** **26" Spider Ring w/Glides** \$140  
*Special shipping required*  
**B6** **26" Polished Aluminum** \$140  
**B9** **28" Chrome** \$160  
**B12** **28" Black** \$110  
**B20** **25" Spider Ring w/Glides** \$145  
*Special shipping required*  
**B22** **22" Black** \$0

## Chair Cylinders

**L1** **3" Cylinder** \$0  
**L3** **5" Cylinder** \$0  
**L14** **10" Dual Stage** \$55

## Stool Cylinders

**L4** **8" Cylinder** \$55  
**L5** **10" Cylinder** \$55  
**L7** **7" Cylinder** \$55

## Footrings for stool cylinders only

**R1** **18" Black Plastic** \$60  
**R2** **20" Chrome** \$80

## NeXtep® for stool cylinders only

**R8** **8" w/Casters** \$185  
**R10** **10" w/Casters** \$185  
**R18** **8"/10" w/Casters** \$295  
**RW8** **Wide 8" w/Casters** \$295  
**RW10** **Wide 10" w/Casters** \$295

Also available w/glides.

For additional stool options  
see page 110.

## NEXTEP®

- Adjustable depth (13", 15" & 17") from cylinder  
*Not available on Wide NeXtep*
- Wide platform for comfortable & ergonomic positioning of the feet & leg support
- Strong, stable step for entering & exiting the stool
- Casters lock when weight is applied
- Supports up to 400 lbs

### Only available on Neutral Posture stools

	w/Glides		w/Locking Casters	
8"	<b>R7</b>	\$135	<b>R8</b>	\$185
10"	<b>R9</b>	\$135	<b>R10</b>	\$185
12"	<b>R11</b>	\$135	<b>R12</b>	\$185
8"/10" Combo	<b>R17</b>	\$235	<b>R18</b>	\$295
10"/12" Combo	<b>R21</b>	\$235	<b>R22</b>	\$295
Wide 8"	<b>RW7</b>	\$235	<b>RW8</b>	\$295
Wide 10"	<b>RW9</b>	\$235	<b>RW10</b>	\$295

*The NeXtep should only be used on stools that meet the current BIFMA tip test standards.*

### R8

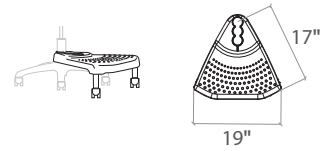

### R18

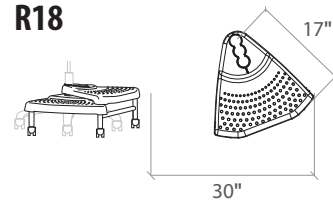

### RW10

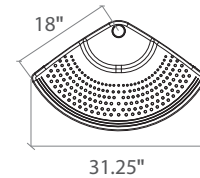

## N-POSITION™

- Wide platform for comfortable & ergonomic positioning of the feet & leg support
- Top surface provides extra raised surface area to support legs while sitting
- Supports up to 400 lbs

**F8** (8" Platform) \$395

**F10** (10" Platform) \$395

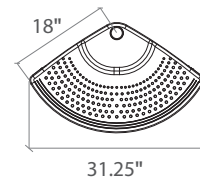
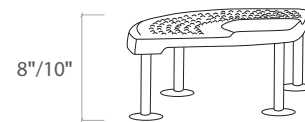



---

## FOOTRINGS

---

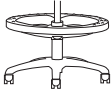

- 18" BLACK PLASTIC**
- Flat textured surface
  - Height adjustable
  - Pressure fit

R1            \$60

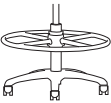

- 20" CHROME**
- Height adjustable
  - Twist/spin tightening

R2            \$80



- FRING® W/BASE**
- Aids shorter workers with a slightly higher "floor"
  - Raised massage bumps provide a gentle rub to shoeless feet

FRF           \$175

---

## FOOTRESTS

---

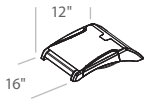

- ADJUSTABLE**
- Easy adjustment, folding support legs provide platform
  - Tilt angles of 6°, 12°, 16° & 25°
  - Provides support for workers under 5<sup>th</sup> percentile
  - Footrest surface covered by anti-fatigue rubber mat

FR16         \$175

---

## **WORKPLACE ACCESSORIES**

---

At Neutral Posture we are about more than just chairs. The office is all about being a place where you can be productive and get your task done with excellence and speed. In order to be the most productive you can be you need accessories to help. Nothing is worse than not having the right tool when you are trying to

complete a task. People of all industries work hard and our accessories collection is here to make life just a little bit easier. From our popular Connexion Arm®, that supports your tablet, to our monitor arms, our accessories are ground-breaking and will elevate your productivity to the next level with ease.

# WORKPLACE ACCESSORIES

---

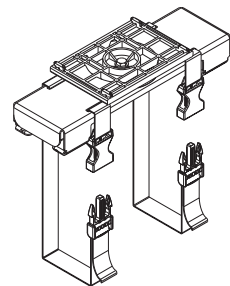
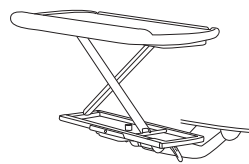
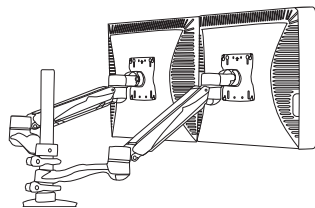
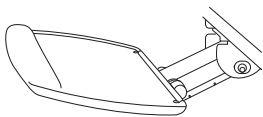

## KEYBOARD ARMS



Leverless



Sit/Stand

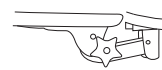

Econo

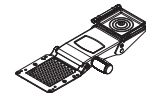

Dual Indicator  
HFES compliant

Code	A	C	E	U
Leverless Height	✓	✓	N/A	N/A
Height	-6" – 2.5"	-6" – 8"	-5.25" – 0"	-6.5" – 2.38"
Tilt	-15° – 0°	-15° – 0°	-15° – 15°	-20° – 10°
Spring Assist	✓	✓	✓	✓
360° Rear Swivel	✓	✓	✓	✓
Track Length	23"	21"	18"	19"
(OPTIONAL) Short Track	18"	18"	N/A	N/A
Glide Track	✓	✓	✓	✓
Quick Ship	QS	QS	QS	
List	\$210	\$230	\$160	\$245

## KEYBOARD TRAYS

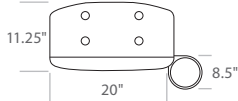

- 11**
- Straights, corners & natural keyboards
  - Anti-skid neoprene pads hold keyboard securely in place

List \$155

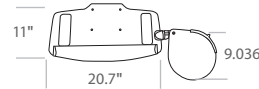

- 52**
- Straight
  - 20" "green" tray
  - Height adjustable tilt & swivel mouse
  - Gel filled palm rest

List \$325

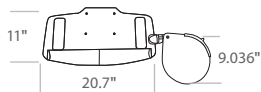

- 21**
- Straight
  - 20" phenolic tray
  - Height adjustable tilt & swivel mouse
  - Gel filled palm rest

List \$325

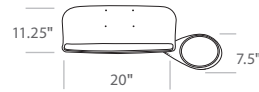

- 86 — ELEMENTAL®**
- Straights, corners and natural keyboards
  - Made from 100% recycled aluminum
  - Polished surface

List \$295

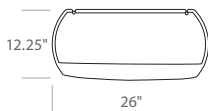





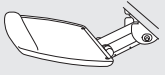
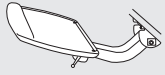

- 43 — SOFTOUCH™**
- Straight
  - Urethane over steel plate
  - Includes mouse surface

List \$230

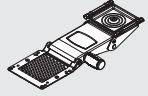
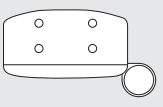
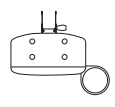
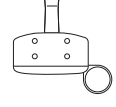
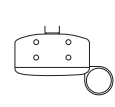
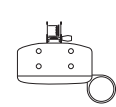
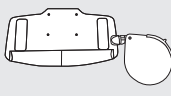
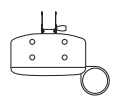
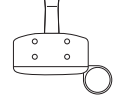
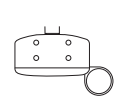
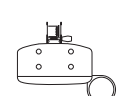

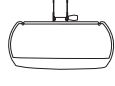
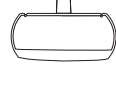
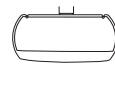
EASY COMBOS

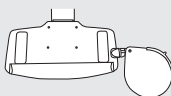
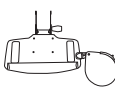
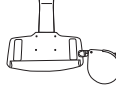
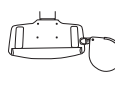
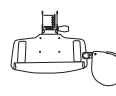
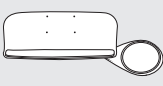
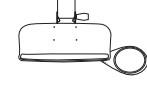
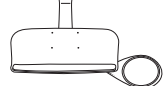
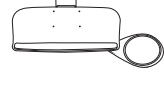
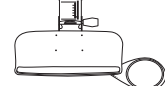
		Keyboard Arms			
					
		Leverless (A)	Sit/Stand (C)	Econo (E)	Dual Indicator (U)
Keyboard Trays	 11	 <b>Easy A11</b> \$365	 <b>Easy C11</b> \$385	 <b>Easy E11</b> \$315	 <b>Easy U11</b> \$400
	 21	 <b>Easy A21</b> \$535	 <b>Easy C21</b> \$555	 <b>Easy E21</b> \$485	 <b>Easy U21</b> \$570
	 43 – SofTouch™	 <b>Easy A43</b> \$440	 <b>Easy C43</b> \$460	 <b>Easy E43</b> \$390	 <b>Easy U43</b> \$475
	 52	 <b>Easy A52</b> \$535	 <b>Easy C52</b> \$555	 <b>Easy E52</b> \$485	 <b>Easy U52</b> \$570
	 86 – elementAI®	 <b>Easy A86</b> \$505	 <b>Easy C86</b> \$525	 <b>Easy E86</b> \$455	 <b>Easy U86</b> \$540

Easy Combo Options

- General
- 5 **Short Track – 18"** \$0  
*Only available on (A) or (C) arm*

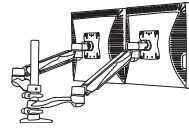

## MONITOR ARMS

### BOOST™ MONITOR ARM

- Yields 13" of vertical movement & 24" of extension
- Supports monitors weighing up to 20 lbs
- Effortlessly position two monitors at the same height on a single post without additional brackets
- Easily attach two arms on a single post without additional brackets
- Install three or more arms with an optional cross bar
- Convenient keyhole slots to effortlessly install monitor onto mounting plate
- Panel, slat wall & desk mounting options

**NOTE: For multi-screen solutions, contact [customerservice@neutralposture.com](mailto:customerservice@neutralposture.com)**

Single Arm	Description	List
KCG-110B	Black	\$455
KCG-110S	Silver	\$455
Double Arm		List
KCG-110DB	Black	\$899
KCG-110DS	Silver	\$899
Wall Mount		List
KCG-WMB	Black	\$525
KCG-WMS	Silver	\$525

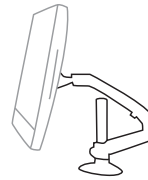

### FREEDOM ARM

- Includes vesa plate aluminum articulating arm & desk clamp base
- Tilt: Up 90°, Down 45°
- Pan: 180°
- Rotation: 360°
- Offers 14" of dynamic one-touch height adjustment
- Full extension range of 23.4"

Model #	Description	List
918001	Silver	\$495

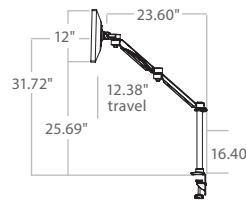

### SIT/STAND MONITOR ARM

- Sturdy aluminum construction with vesa compatibility
- Width & depth adjustable fasteners
- Convenient pull handle
- Brings monitor up to standing height

Model #	Description	List
KCG-SSB	Black	\$575
KCG-SSS	Silver	\$575

## ACCESSORIES

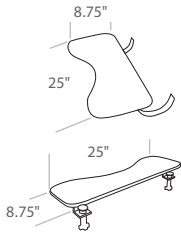

### FOREARM SUPPORTS

- Alleviates shoulder, neck & body burden
- Provides soft transition to protect ulnar nerve
- Lightweight & portable



Model 1	Model 2	
160241 \$240	160243 \$240	w/Hooks
160242 \$240	160244 \$240	w/Screws

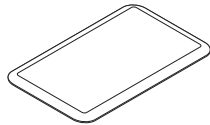

### ANTI-FATIGUE FLOOR MATS

- Premium comfort will not bottom out or lose bounce over time
- Commercial-grade heavy-duty polyurethane
- Matte texture provides optimum traction
- Beveled edge reduces tripping potential
- Available in black

H	W	D	MODEL #	LIST
¾"	32"	20"	<b>EAM3220B</b>	\$285
¾"	48"	20"	<b>EAM4820B</b>	\$435
¾"	72"	20"	<b>EAM7220B</b>	\$648
¾"	36"	24"	<b>EAM3624B</b>	\$360
¾"	60"	36"	<b>EAM6036B</b>	\$828

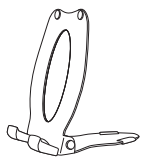

### TABLET HOLDER

- Light weight & portable
- Dimensions: 6.76 x 5.5 x 2
- Holds tablets, phones or documents upright
- Easily adjusts for comfortable viewing angle
- Rests on desktop or flat surfaces

Model #	Description	List
TABHLDR	Black	\$137

## CPU HOLDERS

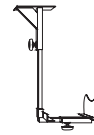

### CPU HOLDER

- Mounts easily under worksurface storing CPU safely under desk & off the floor
- Adjusts to either a vertical or horizontal position
- Adjustable width of 5.5" – 9.8" & height of 15.5" – 20"

Model #	List
VCPUF	\$175

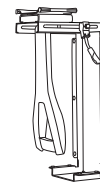

### CPU HOLDER

- CPU retracts on a 17" track & swivels to allow full accessibility & easy storage
- Accommodates CPU weighing up to 75 lbs & measuring 64" in perimeter
- Installation is quick & easy
- Soft touch anti-slip pads prevent CPU from slipping

Model #	List
VCPU	\$195

## ADJUSTABLE HEIGHT TABLES

For adjustable height tables see Equity<sup>NP</sup> Price List

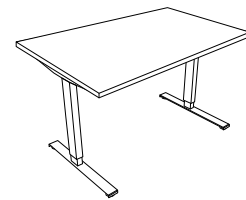

# Workplace Accessories



## STANDUP®

- Retrofits between most existing keyboard trays & keyboard arms
- Mounts directly to worksurface without keyboard arm
- Additional 2" – 11" of height adjustment
- Infinite range positioning
- \$50 discount when ordered with any Easy Combo (page 115)

MODEL #	LIST
SUP04	\$420

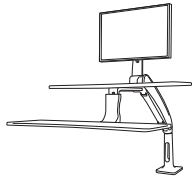

## STANDUP® A1

- The integral dual tray system offers a spacious keyboard & mouse platform as well as a secondary surface for other items
- Extends forward to allow the keyboard tray to rest below the desk surface supporting proper ergonomic positioning
- Over 22" of assisted positioning
- Accommodates users ranging from 5<sup>th</sup> percentile seated female to 95<sup>th</sup> percentile standing male
- Supports monitors weighing between 5–20 lbs
- Supports technology ranging from 5–25 lbs
- Grommet or clamp mount

1 MONITOR	MECH	LIST
SUPA1B	Black	\$997
SUPA1S	Silver	\$997

2 MONITORS	MECH	LIST
SUPA2B	Black	\$1,187
SUPA2S	Silver	\$1,187

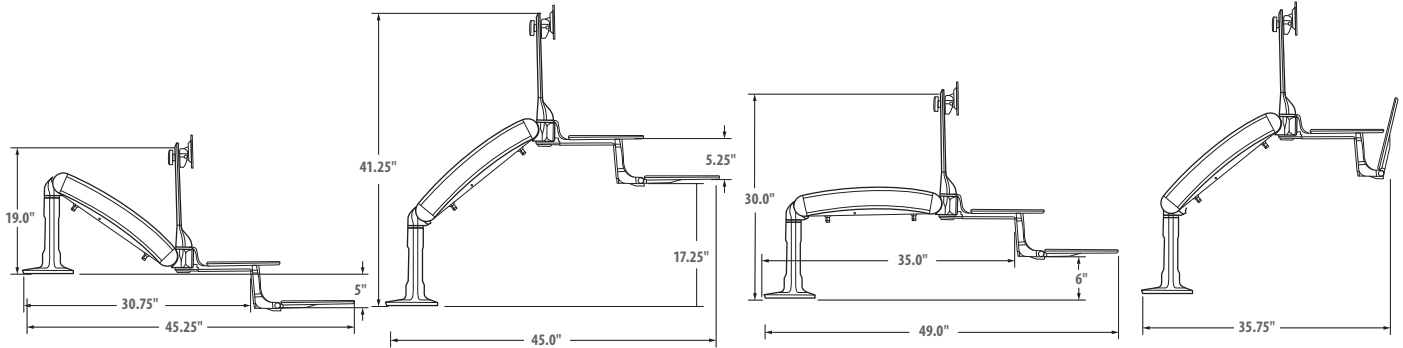
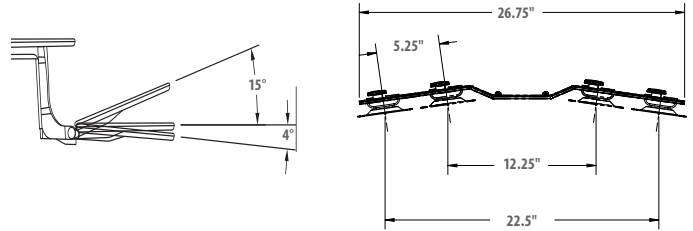

### GROMMET MOUNT

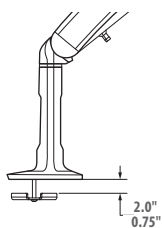

### CLAMP MOUNT

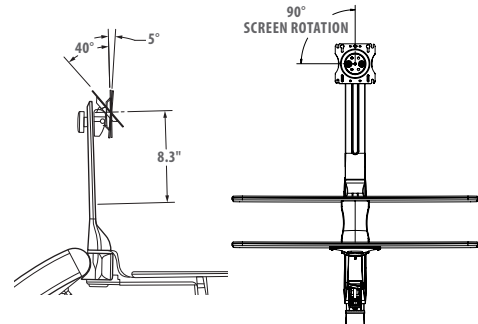
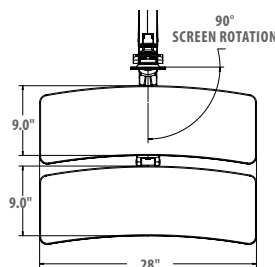
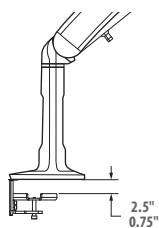





## STANDUP® X1

- Easily convert any desk into a sit/stand workstation
- 13.8" of height range accommodates a variety of users
- Keyboard tray has 20° (-10° to 10°) of tilt
- Weighs only 40 lbs
- Primary worksurface accommodates two 24" monitors
- No assembly required

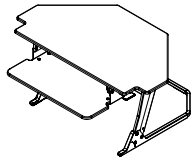
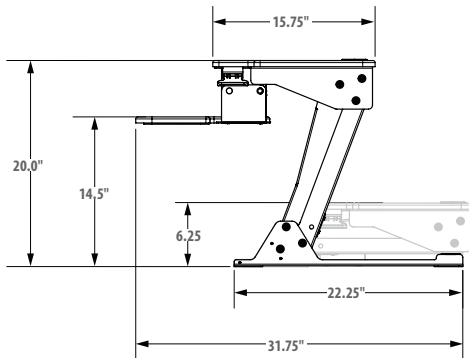

## STANDUP® X1 — CORNER

- Easily convert any desk into a sit/stand workstation
- Designed to fit 90° corner desk configurations
- 13.8" of height range accommodates a variety of users
- Keyboard tray has 20° (-10° to 10°) of tilt
- Weighs only 42 lbs
- Primary worksurface accommodates two 24" monitors
- No assembly required

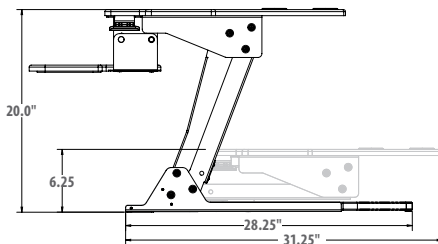

## 36" Wide — Supports up to 35 lbs

MODEL #	MECH	WORKSURFACE	LIST/L1	L2	L3
SUPX136B	Black	N/A	\$ 567	N/A	N/A
SUPX136BL	Black	Laminate	\$ 897	\$ 987	\$ 1,076
SUPX136W	White	N/A	\$ 567	N/A	N/A
SUPX136WL	White	Laminate	\$ 897	\$ 987	\$ 1,076

## 40" Wide — Supports up to 35 lbs

MODEL #	MECH	WORKSURFACE	LIST/L1	L2	L3
SUPX140BL	Black	Laminate	\$ 955	\$ 1,051	\$ 1,146
SUPX140WL	White	Laminate	\$ 975	\$ 1,073	\$ 1,170

## 42" Wide — Supports up to 45 lbs

MODEL #	MECH	WORKSURFACE	LIST/L1	L2	L3
SUPX142B	Black	N/A	\$ 975	N/A	N/A
SUPX142BL	Black	Laminate	\$ 995	\$ 1,095	\$ 1,194

## 48" Wide — Supports up to 45 lbs

MODEL #	MECH	WORKSURFACE	LIST/L1	L2	L3
SUPX148BL	Black	Laminate	\$ 1,175	\$ 1,293	\$ 1,410

## 36" Wide — Supports up to 35 lbs

MODEL #	MECH	WORKSURFACE	LIST/L1	L2	L3
SUPX1CR36BL	Black	Laminate	\$ 1,365	\$ 1,502	\$ 1,638

## 42" Wide — Supports up to 35 lbs

MODEL #	MECH	WORKSURFACE	LIST/L1	L2	L3
SUPX1CR42B	Black	N/A	\$ 995	N/A	N/A
SUPX1CR42BL	Black	Laminate	\$ 1,395	\$ 1,535	\$ 1,674

## LAMINATES FOR STANDUP X1

### L1

Ebony Starlight – Surf(x)  
Matte White – Surf(x)

3D-100  
3D-200

### L2

American Natural – Surf(x)  
Baroque – 3D  
Shaker Cherry – Surf(x)

3D-300  
3D-600  
3D-500

### L3

All other laminates from Omnova are available at L3 pricing with a minimum order of 10 StandUp X1s.

<https://www.omnova.com/product-types/laminates>

# Upholstery

## FABRICS

### Grade 1

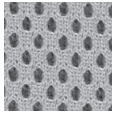

**Spacer**  
Mayer Fabrics  
1,000,000+ double rubs

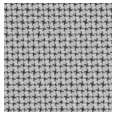

**Cross Check**  
Mayer Fabrics  
258,000 double rubs

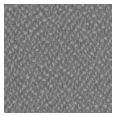

**Forte**  
Mayer Fabrics  
183,000 double rubs

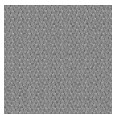

**Quattro**  
Mayer Fabrics  
237,000 double rubs



**Rumba**  
Mayer Fabrics  
55,000 double rubs

### Grade 2

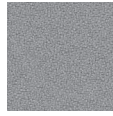

**Ace**  
C.F. Stinson  
1,000,000+ double rubs  
*Not available on NV (3) back*

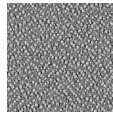

**Foundation 10**  
Mayer Fabrics  
1,000,000 double rubs

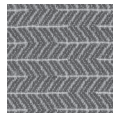

**Jive**  
Mayer Fabrics  
82,000 double rubs

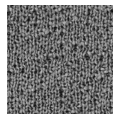

**M Plus**  
Teknit®  
200,000 double rubs  
*Not available on Embrace, Embrace Guest & NV*

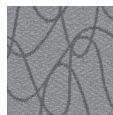

**Samba**  
Mayer Fabrics  
85,000 double rubs

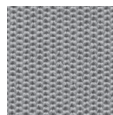

**Top Shelf**  
Guilford of Maine  
250,000 double rubs  
*Not available on Embrace, Embrace Guest & NV*

### Grade 3

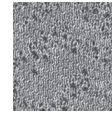

**Cloud 9™**  
335,000 double rubs  
*Not available on Embrace, Embrace Guest & NV*



**Fedora**  
Mayer Fabrics  
100,000 double rubs

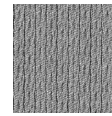

**Moonscape**  
Mayer Fabrics  
378,000 double rubs

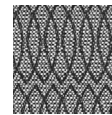

**Reverb**  
Mayer Fabrics  
100,000+ double rubs

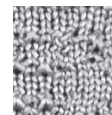

**Revive™**  
Teknit®  
125,000 double rubs  
*Not available on Embrace, Embrace Guest & NV*

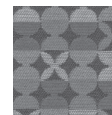

**Tango**  
Mayer Fabrics  
80,000 double rubs

## CAL 133

### Grade 2

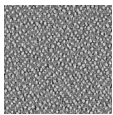

**Foundation 10**  
Mayer Fabrics  
1,000,000 double rubs

## ESD

### Grade 3

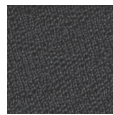

**Cloud 9™ ESD (Thunder Only)**  
*Not available on Embrace, Embrace Guest & NV*

## CRYPTON

### Grade 5

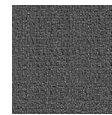

**Finale**  
Mayer Fabrics  
250,000 double rubs

### Grade 4



**Avant**  
C.F. Stinson  
1,500,000 double rubs

### Grade 5

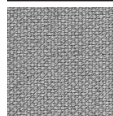

**Nylon Stat**  
Mayer Fabrics  
138,000 double rubs



**Vinyl Stat - ESD**  
Mayer Fabrics  
100,000 double rubs

## LEATHERS/FAUX LEATHERS

### Grade 1

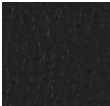
 **Ranchero**  
Mayer  
250,000 double rubs

### Grade 2

 **Dolce (Black Only)**  
Spradling International  
400,000 double rubs

### Grade 3

 **Canter EPU**  
Momentum Textiles  
1,000,000 double rubs

 **Primera®**  
Ultrafabrics®  
400,000 double rubs

 **Nauga Soft**  
Mosehart-Schleeter  
1,000,000 double rubs

### Grade 5

 **Dolce (Colors)**  
Spradling International  
400,000 double rubs

 **Ultraleather™**  
Ultrafabrics®  
400,000 double rubs

### Grade 9

 **Madras**  
335,000 double rubs

## QUICK SHIP FABRICS

### Grade 1

Ranchero	Black	230609
Spacer	Pewter	200651
Spacer	Ink	200649
Spacer	Black	200648
Spacer	Wine	200650

### Grade 2

Ace	Toast	200714
Ace	Peony	200710
Ace	Char	200703
Ace	Midnight	200709
Ace	Jet	200707

### Grade 3

Cloud 9	Red Dawn
Cloud 9	Midnight Sky
Cloud 9	New Haze
Cloud 9	Fog
Cloud 9	Thunder
Revive	Ebony
Revive	Goose
Revive	Ink
Revive	Metal

# Graded In Fabrics

## GRADED IN AND COM UPHOLSTERY

Neutral Posture's furniture is manufactured to the highest standards. The unique nature of upholstery and the other materials that are used in production means that no two pieces will be exactly alike. Fabrics will upholster differently based on composition and construction. Neutral Posture makes every effort to ensure that each item is produced to our exacting standards, but cannot be held responsible for slight variations in upholstery, color and general appearance.

Our artisans are skilled in creating consistent finishes across all products and materials. However, the individual nature of the materials used in the construction of our furniture means that no two pieces of furniture are exactly alike. Similarly, the images in our publications are as accurate as your monitor is calibrated, but customers are reminded that colors and finishes may vary according to the unique nature of each item of furniture.

Neutral Posture will not be responsible for variances in the sit and performance of a chair due to the fact that certain fabrics such as knits will perform differently than milled fabrics. Generally, knitted fabrics will create a softer sit and milled fabrics will provide a firmer sit.

For specific color matching requirements please contact Customer Service.

The Neutral Posture Upholstery Department is pleased to offer a Graded-in program and also accepts C.O.M. for most products. For certain items or in cases of unusual or difficult fabric patterns additional material may be required. Any unusual or special cutting requirements must be requested in writing and a full-width fabric repeat sent to Customer Service in order for a quotation to be provided. The customer is responsible for shipping C.O.M. to our Upholstery Department.

ARC COM		
Manufacturer	Pattern	Grade
Arc Com	Allegra	5
Arc Com	Alpha	5
Arc Com	Analog	7
Arc Com	Apex	6
Arc Com	Arashi	7
Arc Com	Astral	6
Arc Com	Atomic	7
Arc Com	Aurora	6
Arc Com	Axis	6
Arc Com	Bali	7
Arc Com	Block Party	7
Arc Com	Block Petal	6
Arc Com	Blossom	7
Arc Com	Boardwalk	5
Arc Com	Bounce	7
Arc Com	Brayer Flower	7
Arc Com	Bronco	5
Arc Com	Bubbly	7
Arc Com	Campus Stripe	6
Arc Com	Candy Land	7
Arc Com	Carnival	5
Arc Com	Casablanca	6
Arc Com	Cascade	6
Arc Com	Cassio	5
Arc Com	Cavo	7
Arc Com	Centring Stripe	6
Arc Com	Channel	5
Arc Com	Chit-Chat	5
Arc Com	Chroma	5
Arc Com	Cirque	7
Arc Com	Clarion	6
Arc Com	Coastline	5
Arc Com	Column	5
Arc Com	Compass	7
Arc Com	Constantine	8
Arc Com	Contour	5
Arc Com	Cosmos	5
Arc Com	Crescendo	6
Arc Com	Crossroads	6
Arc Com	Crystal	5
Arc Com	Dakota	5
Arc Com	Dakota 2	5
Arc Com	Daytona	7
Arc Com	Dazzle	8
Arc Com	Delphi	5
Arc Com	Delta	5
Arc Com	Drifter	5
Arc Com	Durango	4
Arc Com	Dynasty	6
Arc Com	Eclipse	6
Arc Com	Elementary	7
Arc Com	Elevado	6
Arc Com	Emerson	5
Arc Com	Empress	5
Arc Com	Encore	5
Arc Com	Etch	5
Arc Com	Facet	7
Arc Com	Fiji	5

Manufacturer	Pattern	Grade
Arc Com	Fiore	7
Arc Com	Fireflies	5
Arc Com	Fragment	7
Arc Com	Francesca Wool	8
Arc Com	Francesca Wool II	8
Arc Com	Frontier	4
Arc Com	Galaxy	6
Arc Com	Gamma	5
Arc Com	Gardenia	5
Arc Com	Gatsby	5
Arc Com	Gem	5
Arc Com	Geostitch	7
Arc Com	Gianni	6
Arc Com	Glam	5
Arc Com	Glo	6
Arc Com	Great Wall	6
Arc Com	Grid	6
Arc Com	Hanji	6
Arc Com	Harlequin	6
Arc Com	Highlands	7
Arc Com	Hush	5
Arc Com	Illusion	4
Arc Com	Illusion 2	4
Arc Com	Intaglio	6
Arc Com	Intaglio 2	6
Arc Com	Intersect	5
Arc Com	Interstate	5
Arc Com	Iona	5
Arc Com	Isabella	5
Arc Com	Itajime	6
Arc Com	Jardin	6
Arc Com	Jing	5
Arc Com	Jive	6
Arc Com	Journey	6
Arc Com	Kaolin	5
Arc Com	Kassena	5
Arc Com	Katano	6
Arc Com	Key	5
Arc Com	Kimono	6
Arc Com	Kinetic	6
Arc Com	Kirgami	6
Arc Com	Kuba	6
Arc Com	Kumo	7
Arc Com	Laurel	6
Arc Com	Legacy	6
Arc Com	Legend	6
Arc Com	Linea	6
Arc Com	Loara	6
Arc Com	Lore	6
Arc Com	Lunette	7
Arc Com	Luxe	6
Arc Com	Lyre	5
Arc Com	Lyric	6
Arc Com	Majorca	7
Arc Com	Marathon	5
Arc Com	Marquee	7
Arc Com	Mason	6
Arc Com	Mason Stripe	6
Arc Com	Meadow	6

Manufacturer	Pattern	Grade	Manufacturer	Pattern	Grade	Manufacturer	Pattern	Grade
Arc Com	Mesa	5	Arc Com	Solitude	6	Carnegie	Bolt	9
Arc Com	Mirror Mirror	6	Arc Com	Sonata Stripe	6	Carnegie	Break Line	9
Arc Com	Montage	7	Arc Com	Sonic	6	Carnegie	Brick Lane	6
Arc Com	Moon Beam	6	Arc Com	Spectrum	5	Carnegie	Brigitte Couture S	7
Arc Com	Moon Beam 2	6	Arc Com	Speedway	6	Carnegie	Brimfield	7
Arc Com	Morocco	6	Arc Com	Spinnaker	7	Carnegie	Buff	5
Arc Com	Mystique	6	Arc Com	Spirit	5	Carnegie	Buzz	7
Arc Com	Nahouri	6	Arc Com	Spot On	6	Carnegie	Camden	7
Arc Com	Navigator	6	Arc Com	Spring	6	Carnegie	Cane Embroider S	Call
Arc Com	Network	8	Arc Com	Spyro	6	Carnegie	Carnival	8
Arc Com	Niagara	6	Arc Com	Square One	7	Carnegie	Cascade Applique S	Call
Arc Com	Nova	6	Arc Com	Strata	5	Carnegie	Channel	5
Arc Com	Oculus	6	Arc Com	Streamline	5	Carnegie	Chelsea	5
Arc Com	Odyssey	5	Arc Com	Sukhala	6	Carnegie	Chroma	9
Arc Com	Ombre Petal	6	Arc Com	Sundial	6	Carnegie	Circuit S	6
Arc Com	Omega	5	Arc Com	Symphony	6	Carnegie	Cirque Couture	Call
Arc Com	Orion	5	Arc Com	Sync	5	Carnegie	Coco Couture	7
Arc Com	Pala	7	Arc Com	Tally	5	Carnegie	Collage	7
Arc Com	Palatine	6	Arc Com	Tectonic	5	Carnegie	Cross Stitch	9
Arc Com	Palatine 2	6	Arc Com	The Plaid	8	Carnegie	Crossing	6
Arc Com	Panache	5	Arc Com	Theory	3	Carnegie	Cycle X	6
Arc Com	Pebble Beach	5	Arc Com	Top Notch	Call	Carnegie	Dash X	6
Arc Com	Perspective	6	Arc Com	Traverse	6	Carnegie	Dawn	5
Arc Com	Plateau	5	Arc Com	Tritik	6	Carnegie	Dazzle	8
Arc Com	Polished	6	Arc Com	Uptown	8	Carnegie	Deco Embroider S	9
Arc Com	Polo	6	Arc Com	Urban	6	Carnegie	Departure	5
Arc Com	Posh	7	Arc Com	Vault	6	Carnegie	Edge	6
Arc Com	Primavera	5	Arc Com	Velocity	7	Carnegie	Elite	3
Arc Com	Prism	4	Arc Com	Venture	7	Carnegie	Fine Line	7
Arc Com	Provence	Call	Arc Com	Vineyard	6	Carnegie	Flash Back S	6
Arc Com	Quest	7	Arc Com	Vivo	6	Carnegie	Flex	5
Arc Com	Radius	7	Arc Com	Volt	8	Carnegie	Flux X	6
Arc Com	Raya	6	Arc Com	Wanderer	8	Carnegie	Four Square	7
Arc Com	Reality Check	5	Arc Com	Windlass	7	Carnegie	Fractal Emboss S	6
Arc Com	Ringling	6	Arc Com	Yo-Yo	7	Carnegie	Fragment Emboss S	6
Arc Com	Riviera	7	Arc Com	Zip Line	6	Carnegie	Fresco	6
Arc Com	Rbotic	6				Carnegie	Fusion	6
Arc Com	Rodeo	5				Carnegie	Gamma S	5
Arc Com	Rodeo 2	5				Carnegie	Genome Embroider S	9
Arc Com	Rogue	6				Carnegie	Groove	5
Arc Com	Roundabout	5				Carnegie	Hashtag	5
Arc Com	Sagrada	7				Carnegie	Havana X	6
Arc Com	Sahara	6				Carnegie	Haze X	7
Arc Com	Samba	6				Carnegie	Hepburn	6
Arc Com	Santa Fe	6				Carnegie	Herald	5
Arc Com	Santorini	7				Carnegie	Herringbone X	5
Arc Com	Saxon	6				Carnegie	Hide	5
Arc Com	Sea Willow	6				Carnegie	High Line	7
Arc Com	Sector	6				Carnegie	Hive	7
Arc Com	Sequoia	6				Carnegie	Hoop Embroider S	8
Arc Com	Sherlock	5				Carnegie	Hue	6
Arc Com	Sherlock 2	5				Carnegie	Icon	9
Arc Com	Shibori	6				Carnegie	Impress	5
Arc Com	Shift	6				Carnegie	Index	4
Arc Com	Shimmer	5				Carnegie	Infinity Plaid	8
Arc Com	Shimmer 2	5				Carnegie	Infinity Plush	8
Arc Com	Silverado	5				Carnegie	Infinity Stripe	8
Arc Com	Silverado 2	5				Carnegie	Journey	7
Arc Com	Skye	7				Carnegie	Kaleidoscope S	6

CARNEGIE		
Manufacturer	Pattern	Grade
Carnegie	360	9
Carnegie	Abacus Embroider S	8
Carnegie	Alex	8
Carnegie	Allure	5
Carnegie	Anchor	7
Carnegie	Antoinette Couture S	7
Carnegie	Aria	Call
Carnegie	Artisan Embroider S	9
Carnegie	Axis Embroider S	8
Carnegie	Bangle	7
Carnegie	Bardot	6
Carnegie	Barre	7
Carnegie	Basket	6
Carnegie	Bauble	8
Carnegie	Bliss	7
Carnegie	Blowing Bubbles	7

# Graded In Fabrics

Manufacturer	Pattern	Grade	Manufacturer	Pattern	Grade	Manufacturer	Pattern	Grade
Carnegie	Keystone	5	Carnegie	Tweed S	6	C.F. Stinson	Channel	5
Carnegie	Kid	5	Carnegie	Twine	6	C.F. Stinson	Charlotte	4
Carnegie	Kinetic	7	Carnegie	Ultra	6	C.F. Stinson	Chroma	5
Carnegie	Koi	7	Carnegie	Veneer Emboss X	6	C.F. Stinson	Cimena	6
Carnegie	Linen X	5	Carnegie	Versailles Emboss X	6	C.F. Stinson	Chi w/ Agion®	7
Carnegie	Low Line	7	Carnegie	Verse	4	C.F. Stinson	Cinnamon Blossom	6
Carnegie	Maxim	5	Carnegie	Vibe	6	C.F. Stinson	Circulate w/ Celliant	6
Carnegie	Maxwell Street	9	Carnegie	Vintage	7	C.F. Stinson	Cirro	6
Carnegie	Maze	7	Carnegie	Whirlybird	7	C.F. Stinson	Cirque	5
Carnegie	Merge	6	Carnegie	Wish	7	C.F. Stinson	Citadel	4
Carnegie	Merkhet	6				C.F. Stinson	Clean Slate	5
Carnegie	Mesh X	6				C.F. Stinson	Coco	6
Carnegie	Meteor X	6				C.F. Stinson	Colden	6
Carnegie	Moire Stripe Couture S	7				C.F. Stinson	Color Black	7
Carnegie	Monocle Embroider	9				C.F. Stinson	Colorguard	3
Carnegie	Monroe	6				C.F. Stinson	Comeback	7
Carnegie	Moto	6				C.F. Stinson	Concentric	6
Carnegie	Ola	Call				C.F. Stinson	Connect	4
Carnegie	Origin	5				C.F. Stinson	Continuum	5
Carnegie	Oxford	5				C.F. Stinson	Core	3
Carnegie	Pivot	6				C.F. Stinson	Cottonwood	5
Carnegie	Pixie Applique X	Call				C.F. Stinson	Courtyard	6
Carnegie	Pony	5				C.F. Stinson	Cozy	5
Carnegie	Pop Emboss X	6				C.F. Stinson	Criss Cross	4
Carnegie	Prime	5				C.F. Stinson	Crypton Metro	5
Carnegie	Prism X	6				C.F. Stinson	Crystalline	6
Carnegie	Quarry X	6				C.F. Stinson	Current	7
Carnegie	Rattan X	5				C.F. Stinson	Curves Ahead	6
Carnegie	Reef X	5				C.F. Stinson	Cyma	6
Carnegie	Relay	9				C.F. Stinson	Dart	4
Carnegie	Reveal	8				C.F. Stinson	Deflection	6
Carnegie	Reverie	5				C.F. Stinson	Detail	5
Carnegie	Revolve	7				C.F. Stinson	Deza	7
Carnegie	Rise	3				C.F. Stinson	Diffusion	7
Carnegie	Roxy	5				C.F. Stinson	Diva	5
Carnegie	Sequence X	6				C.F. Stinson	Division	5
Carnegie	Spark	9				C.F. Stinson	Dodgeball	6
Carnegie	Silhouette Embroider X	8				C.F. Stinson	Donegal	5
Carnegie	Siltech Press	7				C.F. Stinson	Double Time w/ Agion	7
Carnegie	Sleet Embroider X	8				C.F. Stinson	Drizzle	7
Carnegie	Slide X	6				C.F. Stinson	Duet	5
Carnegie	Spice	7				C.F. Stinson	Elderberry	7
Carnegie	Spire X	6				C.F. Stinson	English Pub	4
Carnegie	Spyro Embroider X	7				C.F. Stinson	Enhance w/ Celliant	6
Carnegie	Strata X	5				C.F. Stinson	Equinox	5
Carnegie	Stride	Call				C.F. Stinson	Essential	3
Carnegie	Strie X	5				C.F. Stinson	Euclid	4
Carnegie	Sway Embroider S	8				C.F. Stinson	Expressions	4
Carnegie	Switch X	6				C.F. Stinson	Fast Lane	4
Carnegie	Switch Embroider X	8				C.F. Stinson	Fenestra	7
Carnegie	Tangle	6				C.F. Stinson	Figment	6
Carnegie	Theory	5				C.F. Stinson	Firefly	7
Carnegie	Tilt	7				C.F. Stinson	Fizz	5
Carnegie	Topiary Embroider X	9				C.F. Stinson	Flanders	4
Carnegie	Trace X	7				C.F. Stinson	Fleck	3
Carnegie	Trestle	7				C.F. Stinson	Flex	5
Carnegie	Triad	7				C.F. Stinson	Flip Flops	6
Carnegie	Triad Stripe	7				C.F. Stinson	Florentine	5
Carnegie	Triathlon	7				C.F. Stinson	Folio	6
C.F. STINSON								
Manufacturer	Pattern	Grade						
C.F. Stinson	Ace	2						
C.F. Stinson	Acanthus	6						
C.F. Stinson	Acrobat	7						
C.F. Stinson	Adaigo	5						
C.F. Stinson	Adirondack	6						
C.F. Stinson	Aero	5						
C.F. Stinson	Alchemy	5						
C.F. Stinson	Alfresco	6						
C.F. Stinson	Algiers	7						
C.F. Stinson	Alignment	6						
C.F. Stinson	Amplify	3						
C.F. Stinson	Anagram	5						
C.F. Stinson	Arc	5						
C.F. Stinson	Ardent	4						
C.F. Stinson	Artisan	4						
C.F. Stinson	Atlas	3						
C.F. Stinson	Avant	4						
C.F. Stinson	Balance Beam	6						
C.F. Stinson	Bali	6						
C.F. Stinson	Bass Line	6						
C.F. Stinson	Beatbox	6						
C.F. Stinson	Bespoke	5						
C.F. Stinson	Bistro	4						
C.F. Stinson	Blip	4						
C.F. Stinson	Block Party	6						
C.F. Stinson	Bloom	8						
C.F. Stinson	Bongo	6						
C.F. Stinson	Boost w/ Celliant	6						
C.F. Stinson	Borderline	6						
C.F. Stinson	Breton	6						
C.F. Stinson	Brilliant	4						
C.F. Stinson	Broadband	6						
C.F. Stinson	Bryant Park	3						
C.F. Stinson	Burkshire	4						
C.F. Stinson	Calibration	6						
C.F. Stinson	Cannon Beach	7						
C.F. Stinson	Carlisle	4						
C.F. Stinson	Cassidy	4						
C.F. Stinson	Catalina	6						
C.F. Stinson	Catalyst	4						
C.F. Stinson	Catwalk	5						
C.F. Stinson	Celeste	6						
C.F. Stinson	Chakra	7						

Manufacturer	Pattern	Grade	Manufacturer	Pattern	Grade	Manufacturer	Pattern	Grade
C.F. Stinson	Fractal	6	C.F. Stinson	Maxwell	4	C.F. Stinson	Rialto	4
C.F. Stinson	Frequency	5	C.F. Stinson	Maze	7	C.F. Stinson	Riddle	4
C.F. Stinson	Full Tum	7	C.F. Stinson	Mica	5	C.F. Stinson	Ritz	5
C.F. Stinson	Furrows	4	C.F. Stinson	Migration	7	C.F. Stinson	Rogue II	3
C.F. Stinson	Fuse	3	C.F. Stinson	Mingle	6	C.F. Stinson	Salinas	8
C.F. Stinson	Geomet	5	C.F. Stinson	Moby	3	C.F. Stinson	San Simeon	7
C.F. Stinson	Gradation	5	C.F. Stinson	Moccasin	4	C.F. Stinson	Satellite	5
C.F. Stinson	Grand Sierra	4	C.F. Stinson	Modernist	7	C.F. Stinson	Scintillate	6
C.F. Stinson	Gravity	5	C.F. Stinson	Monhegan	6	C.F. Stinson	Scout	4
C.F. Stinson	Grove	6	C.F. Stinson	Montage	5	C.F. Stinson	Script	5
C.F. Stinson	Hands On	6	C.F. Stinson	Montana	4	C.F. Stinson	Seagrass	6
C.F. Stinson	Handwork	6	C.F. Stinson	Mumbai	7	C.F. Stinson	Season	7
C.F. Stinson	Happy Hour	5	C.F. Stinson	Neochrome III	4	C.F. Stinson	Semaphore	5
C.F. Stinson	Happy Tappy	7	C.F. Stinson	Network	5	C.F. Stinson	Sensor	6
C.F. Stinson	Haven	5	C.F. Stinson	Nest	6	C.F. Stinson	Sequence	4
C.F. Stinson	Helix	6	C.F. Stinson	Next Scene	6	C.F. Stinson	Serene	7
C.F. Stinson	Hi-Fi	4	C.F. Stinson	Nimble	6	C.F. Stinson	Shantung	4
C.F. Stinson	Highlight	4	C.F. Stinson	Nova	5	C.F. Stinson	Shift	4
C.F. Stinson	Hive	4	C.F. Stinson	Now & Zen w/ Agion	7	C.F. Stinson	Shimmy	5
C.F. Stinson	Hopsake	5	C.F. Stinson	Naugasoft	4	C.F. Stinson	Shuffle	8
C.F. Stinson	Hot Spot	5	C.F. Stinson	Nishiki	4	C.F. Stinson	Sideline	5
C.F. Stinson	Hourglass	6	C.F. Stinson	Olivia	3	C.F. Stinson	Silver Point	6
C.F. Stinson	Hudson	7	C.F. Stinson	On the Money	5	C.F. Stinson	Sirocco	6
C.F. Stinson	Hush	6	C.F. Stinson	Orbit	5	C.F. Stinson	Skyline	6
C.F. Stinson	I Spy	6	C.F. Stinson	Oscillate	6	C.F. Stinson	Sleek	5
C.F. Stinson	Infinity Plush	7	C.F. Stinson	Outlander	4	C.F. Stinson	Sleeping Bear Dunes	6
C.F. Stinson	Inside Track	4	C.F. Stinson	Overlay	5	C.F. Stinson	Smile	6
C.F. Stinson	Interval	5	C.F. Stinson	Oxford	4	C.F. Stinson	Smoothie	4
C.F. Stinson	Isabella	6	C.F. Stinson	Pacifica	7	C.F. Stinson	Snuggle	5
C.F. Stinson	Jala	7	C.F. Stinson	Panorama	6	C.F. Stinson	Spindles	7
C.F. Stinson	Jam Session w/ Agion	7	C.F. Stinson	Paradox	6	C.F. Stinson	Spirit Millennium	4
C.F. Stinson	Jambi Stripe	6	C.F. Stinson	Park Avenue	6	C.F. Stinson	Splash	6
C.F. Stinson	Kambala	7	C.F. Stinson	Passport	6	C.F. Stinson	Splice	7
C.F. Stinson	Kennebunk	6	C.F. Stinson	Patriot Plus II	3	C.F. Stinson	Sprint	3
C.F. Stinson	Ketana	6	C.F. Stinson	Penelope	5	C.F. Stinson	Squire	5
C.F. Stinson	Kilkenny Tweed	4	C.F. Stinson	Peninsula Mohair	9	C.F. Stinson	Stellar	5
C.F. Stinson	Kinectic	6	C.F. Stinson	Pergola	5	C.F. Stinson	Steppe	6
C.F. Stinson	Knock Knock	7	C.F. Stinson	Perimeter	5	C.F. Stinson	Stipple	5
C.F. Stinson	Knot	5	C.F. Stinson	Persuasion	5	C.F. Stinson	Stitch in Time	4
C.F. Stinson	Kusari	5	C.F. Stinson	Piccadilly	5	C.F. Stinson	Storyboard	7
C.F. Stinson	Labyrinth	6	C.F. Stinson	Pinball	5	C.F. Stinson	Straight and Narrow	6
C.F. Stinson	Lara	3	C.F. Stinson	Pivot	4	C.F. Stinson	Strand	4
C.F. Stinson	Lateral	3	C.F. Stinson	Polka	4	C.F. Stinson	Stratford	8
C.F. Stinson	Leaps & Bounds	6	C.F. Stinson	Portico	5	C.F. Stinson	Stride	5
C.F. Stinson	Level	5	C.F. Stinson	Posey	5	C.F. Stinson	Sumatran Palm	6
C.F. Stinson	Lifecycle	7	C.F. Stinson	Posh	5	C.F. Stinson	Summit	5
C.F. Stinson	Lift	7	C.F. Stinson	Power Grid	6	C.F. Stinson	Sunburst	6
C.F. Stinson	Line Dance	5	C.F. Stinson	Profile	5	C.F. Stinson	Sunswept	6
C.F. Stinson	Links	6	C.F. Stinson	Promenade	5	C.F. Stinson	Supersillyness	7
C.F. Stinson	Loophole	5	C.F. Stinson	Queue	6	C.F. Stinson	Swipe	6
C.F. Stinson	Lucent	7	C.F. Stinson	Radiance	7	C.F. Stinson	Swivel	6
C.F. Stinson	Luster	5	C.F. Stinson	Raffia	5	C.F. Stinson	Symmetry	6
C.F. Stinson	Makeover	7	C.F. Stinson	Rainier	4	C.F. Stinson	Symphony Classic	4
C.F. Stinson	Manchester	5	C.F. Stinson	Rally	3	C.F. Stinson	Tangram	5
C.F. Stinson	Mandala	5	C.F. Stinson	Raquette	6	C.F. Stinson	Tendril	4
C.F. Stinson	Mantra	7	C.F. Stinson	Realm	5	C.F. Stinson	Tessellate	6
C.F. Stinson	Marimba	6	C.F. Stinson	Recharge w/ Celliant	6	C.F. Stinson	Tessuto	4
C.F. Stinson	Marquetry	6	C.F. Stinson	Retrograde	4	C.F. Stinson	Thicket	4
C.F. Stinson	Matrix	5	C.F. Stinson	Revolution	6	C.F. Stinson	Three60	7



# Graded In Fabrics

Manufacturer	Pattern	Grade	Manufacturer	Pattern	Grade	Manufacturer	Pattern	Grade
C.F. Stinson	Thrive	7	Designtex	Birdseye	3	Designtex	Holmes	8
C.F. Stinson	Tidbit	6	Designtex	Bitdrift	7	Designtex	Hyde	4
C.F. Stinson	Torus	6	Designtex	Botanique	5	Designtex	Hyphen	6
C.F. Stinson	Touch Bsaе	5	Designtex	Boucle	7	Designtex	Inertia	7
C.F. Stinson	Tranquility	6	Designtex	Boucle Dot	6	Designtex	Inga Large	8
C.F. Stinson	Transcend	3	Designtex	Breena	5	Designtex	Inga Small	8
C.F. Stinson	Tribeca	4	Designtex	Brushed Flannel	5	Designtex	Inkling	7
C.F. Stinson	Trio	7	Designtex	Bunta	6	Designtex	Inkling	7
C.F. Stinson	True Path w/ Agion	7	Designtex	Burlap Weave	6	Designtex	Inside Edge	6
C.F. Stinson	Tweed	6	Designtex	Bute Braemar	9	Designtex	Interlock	6
C.F. Stinson	Twiggy	5	Designtex	Bute Lewis	9	Designtex	Jaunt	7
C.F. Stinson	Umbrian Rain	7	Designtex	Bute Melrose	9	Designtex	Josef	6
C.F. Stinson	Up Tempo w/ Agion	7	Designtex	Bute Storr	Call	Designtex	Journey	9
C.F. Stinson	Urban Grid	3	Designtex	Bute Tiree	Call	Designtex	Kami	8
C.F. Stinson	Vanish	7	Designtex	Bute Tweed	9	Designtex	Lambert	8
C.F. Stinson	Vapor	7	Designtex	Capsule	7	Designtex	Latitude	7
C.F. Stinson	Vegas	4	Designtex	Carrick	9	Designtex	Lattice	7
C.F. Stinson	Velocity	5	Designtex	Cassava	6	Designtex	Leap	6
C.F. Stinson	Vermont	6	Designtex	Catalyst	5	Designtex	Leaves	6
C.F. Stinson	Vibe	5	Designtex	Chapiteau	5	Designtex	Line Variations	7
C.F. Stinson	View	7	Designtex	Circa	6	Designtex	Little Dot	6
C.F. Stinson	Vineyard	7	Designtex	Clerkenwell	Call	Designtex	Luster	6
C.F. Stinson	Voltage	7	Designtex	Code	6	Designtex	Mark	5
C.F. Stinson	Walk the Line	6	Designtex	Collier	5	Designtex	Measure	5
C.F. Stinson	Whirl	6	Designtex	Colten	5	Designtex	Melange	5
C.F. Stinson	Whisper	4	Designtex	Concept	7	Designtex	Metallo	6
C.F. Stinson	Willow Talk	6	Designtex	Connor	5	Designtex	Metta	5
C.F. Stinson	Wish	8	Designtex	Course	7	Designtex	Microgrid	5
C.F. Stinson	Ziggy	4	Designtex	Crisscross	7	Designtex	Migration	9
C.F. Stinson	Zoom	5	Designtex	Crosshatch	7	Designtex	Mingle	7
C.F. Stinson	Zodiac	5	Designtex	Crossweave	5	Designtex	Minnie	4
			Designtex	Crosswind	6	Designtex	Mod	7
			Designtex	Cubitt	7	Designtex	Modern Tweed	9
			Designtex	Current	6	Designtex	Mohair Plus	Call
			Designtex	Dart	7	Designtex	Motif	6
			Designtex	Delaine	6	Designtex	Myddleton	Call
			Designtex	Distressed Texture	6	Designtex	Net	7
			Designtex	Divide	7	Designtex	New Brunswick	3
			Designtex	Draft	6	Designtex	Nexus	7
			Designtex	Ellipsis	4	Designtex	Opulent	5
			Designtex	Faux Sure	7	Designtex	Oscillate	7
			Designtex	Five Cities	7	Designtex	Otto	6
			Designtex	Florin	6	Designtex	Oxford Stripe	7
			Designtex	Fluent	7	Designtex	Pause	6
			Designtex	Fomo	5	Designtex	Pennington	7
			Designtex	Forestbound	5	Designtex	Phenomena	7
			Designtex	Fortuna	8	Designtex	Pigment	8
			Designtex	Friendly Faux	7	Designtex	Pika	5
			Designtex	Gale	6	Designtex	Pinball	7
			Designtex	Gleam	6	Designtex	Pinpoint	7
			Designtex	Gradate	6	Designtex	Pivot	5
			Designtex	Gridley	5	Designtex	Pixel	7
			Designtex	Halyard	8	Designtex	Plaid	7
			Designtex	Hashtag	5	Designtex	Pleat	7
			Designtex	Heather	7	Designtex	Pop Art	7
			Designtex	Hem Stitch	5	Designtex	Posey	7
			Designtex	Henrik Large	8	Designtex	Prompt	7
			Designtex	Henrik Small	8	Designtex	Rail	6
			Designtex	Hexstripe	6	Designtex	Rainwater	7

## DESIGNTEX

Manufacturer	Pattern	Grade
Designtex	Adler	5
Designtex	Air	9
Designtex	Alcazar	5
Designtex	Alchemy	5
Designtex	Aloft	5
Designtex	Alpine	5
Designtex	Amwell	Call
Designtex	Angle	8
Designtex	Annex	5
Designtex	Anni	8
Designtex	Appleseed	6
Designtex	Arni	5
Designtex	Arthur	Call
Designtex	Aspect	4
Designtex	Aster	8
Designtex	Bark Cloth	6
Designtex	Bead	7
Designtex	Beguiled By The Wild	6
Designtex	Big Dot	6
Designtex	Big Texture	6
Designtex	Billiard Cloth	6
Designtex	Birch Bark Plaid	7



Manufacturer	Pattern	Grade
Designtex	Reppweave	5
Designtex	Revelry	6
Designtex	Rise	5
Designtex	Rocket	5
Designtex	Rodenbach	8
Designtex	Rotary	7
Designtex	Rothsay	8
Designtex	Round Leaves	8
Designtex	Rove	6
Designtex	Rumeli	5
Designtex	Sail	7
Designtex	Samba	8
Designtex	Savile Plaid	8
Designtex	Scale	6
Designtex	Schism	5
Designtex	Score	7
Designtex	Segment	8
Designtex	Shimmering Tide	9
Designtex	Shortcut	7
Designtex	Silicone Element	7
Designtex	Singing in he Rain	5
Designtex	Sketch	7
Designtex	Social Dance	7
Designtex	Sorano	5
Designtex	Spandau	5
Designtex	Splendor	5
Designtex	Splice	5
Designtex	Split	5
Designtex	Sprint	7
Designtex	Starburst	7
Designtex	Strand	6
Designtex	Striae	6
Designtex	Stride	5
Designtex	Subtle	5
Designtex	Sunburst	8
Designtex	Swing	7
Designtex	Symbol	9
Designtex	System	5
Designtex	Tack Cloth	7
Designtex	Terra	6
Designtex	The Last Aphid	8
Designtex	Tiny Herringbone	6
Designtex	Tramway	7
Designtex	Treeline	7
Designtex	Triform	6
Designtex	Trim	7
Designtex	Trove	5
Designtex	Tumbleweed	6
Designtex	Turn	7
Designtex	Tweed Multi	5
Designtex	Ulster	3
Designtex	Ulster Upholstery	4
Designtex	Union Cloth Upholstery	5
Designtex	Urban Grid	7
Designtex	Vero	6
Designtex	Vine	7
Designtex	Vivid	4
Designtex	W	6
Designtex	Whim	6

Manufacturer	Pattern	Grade
Designtex	Windowpane Crypton	6
Designtex	Woodcut	6
Designtex	Yucca	6

## GUILFORD OF MAINE

Manufacturer	Pattern	Grade
Guilford of Maine	Adept	2
Guilford of Maine	Aquatint	2
Guilford of Maine	Beacon	2
Guilford of Maine	BeeHave	2
Guilford of Maine	Blink	2
Guilford of Maine	Blinker	2
Guilford of Maine	Cabana Stripe	2
Guilford of Maine	Cadence	2
Guilford of Maine	Clarity	3
Guilford of Maine	Couture	2
Guilford of Maine	Ditty	2
Guilford of Maine	Diva	2
Guilford of Maine	Echo	3
Guilford of Maine	Emphasis	4
Guilford of Maine	Evoke	3
Guilford of Maine	Feedback	4
Guilford of Maine	Flora	2
Guilford of Maine	Frolic	2
Guilford of Maine	George	4
Guilford of Maine	Highbeams	1
Guilford of Maine	Input	2
Guilford of Maine	Instant	3
Guilford of Maine	Intuition	3
Guilford of Maine	Jane	2
Guilford of Maine	Lexicon	3
Guilford of Maine	Liberty (Playful)	2
Guilford of Maine	Lifesaver	2
Guilford of Maine	Limelight	3
Guilford of Maine	Lisbon	3
Guilford of Maine	Mainstream	3
Guilford of Maine	Moguls	3
Guilford of Maine	Moment	2
Guilford of Maine	Open House	1
Guilford of Maine	Outline	2
Guilford of Maine	Oxford	2
Guilford of Maine	Phrase	2
Guilford of Maine	Portofino	3
Guilford of Maine	Quadrille	2
Guilford of Maine	Reason	3
Guilford of Maine	Recharge	3
Guilford of Maine	Relay	3
Guilford of Maine	Revival	4
Guilford of Maine	Ripple	3
Guilford of Maine	Select	3
Guilford of Maine	Showtime	2
Guilford of Maine	Snakeskin	2
Guilford of Maine	Soundbyte	2
Guilford of Maine	Staccato	3
Guilford of Maine	Synopsis	2
Guilford of Maine	Ticker	2

Manufacturer	Pattern	Grade
Guilford of Maine	Timeless	2
Guilford of Maine	Tracery	2
Guilford of Maine	Transport	2
Guilford of Maine	Underground	2
Guilford of Maine	Whirl	3
Guilford of Maine	Xceed	3

## LUNA

Manufacturer	Pattern	Grade
Luna	Acolyte	8
Luna	Affinity	7
Luna	Alexander	5
Luna	Allegra	8
Luna	Allure	Call
Luna	Aspect	7
Luna	Beam	8
Luna	Betwixt	6
Luna	Blueprint	6
Luna	Boink	7
Luna	Boomerang	8
Luna	Boucle Stripe	7
Luna	Boutique	7
Luna	Broome	8
Luna	Bungalow	7
Luna	Burst	7
Luna	Charm	Call
Luna	Cloud	8
Luna	Coco	Call
Luna	Copa	6
Luna	Cozy	Call
Luna	Dapple	7
Luna	Delight	6
Luna	Dish	5
Luna	Doodad	8
Luna	Dots Damask	7
Luna	Downtown Two	5
Luna	Ellwood	6
Luna	Enchant	9
Luna	Endless	8
Luna	Ensemble	Call
Luna	Entenza	6
Luna	Esperanto	8
Luna	Facet	7
Luna	Filament	8
Luna	Flare	8
Luna	Flash	7
Luna	Framework	5
Luna	Freehand	5
Luna	Gizmo	8
Luna	Halo	5
Luna	Hardcopy	6
Luna	Hardware	8
Luna	Harmonize	5
Luna	Hatch	8
Luna	Hatch Too	5
Luna	HiFi	5

# Graded In Fabrics

Manufacturer	Pattern	Grade
Luna	Highlight	6
Luna	Hush	6
Luna	Idyll	5
Luna	Incandescent	5
Luna	Intersect	5
Luna	Jaunty	6
Luna	Linea	4
Luna	Linen	7
Luna	Loggia	6
Luna	Loop	8
Luna	Luna Atelier 01	8
Luna	Matchsticks	6
Luna	Mezzanine	6
Luna	Micro Bubbly	9
Luna	Mobile	7
Luna	Motif.	7
Luna	Nifty	4
Luna	Notion	5
Luna	Peek	8
Luna	Plaza	6
Luna	Propeller	9
Luna	Radar	5
Luna	Redfern	Call
Luna	Redondo	8
Luna	Signal	5
Luna	Sketch Stripe	9
Luna	Snug	Call
Luna	Sonic	5
Luna	Sparkle	6
Luna	Spellbound	9
Luna	Splice	5
Luna	Staccato	8
Luna	Stacking Chairs	8
Luna	Stars	6
Luna	Stepping Stones	5
Luna	Stitch	5
Luna	Switchback	6
Luna	Tech Stripe	8
Luna	Tech Twist	6
Luna	Telepathy	7
Luna	Token	6
Luna	Transmission	5
Luna	Trapeze	4
Luna	Twiggy	8
Luna	Twight 2.0	5
Luna	Twist	5
Luna	Urban Grid	8
Luna	Waffle	5
Luna	Wallflower	5
Luna	Whimsy	6
Luna	Winsome	Call
Luna	Wish	6
Luna	Woohl	5

LUUM		
Manufacturer	Pattern	Grade
Luum	Actuate	5
Luum	Adage	6
Luum	Amalgam	7
Luum	Ample	5
Luum	Angulo	8
Luum	Arc Angle	9
Luum	Beaded Stripe	5
Luum	Complement	5
Luum	Cross Dye	5
Luum	Disrupt	7
Luum	Filar	5
Luum	Flexagon	6
Luum	Full Wool	9
Luum	Fundamentals	5
Luum	Ghat	7
Luum	Heather Felt	8
Luum	Heather Tech	4
Luum	Homage	7
Luum	Implex	5
Luum	Interstice	6
Luum	Intone	5
Luum	Iterate	8
Luum	Knurl	7
Luum	Line Language	7
Luum	Magnify	4
Luum	Marl Cloth	5
Luum	Miami	6
Luum	Modulud	6
Luum	Navigate	Call
Luum	Outpress	7
Luum	Percept	5
Luum	Point Set	7
Luum	Point to Point	7
Luum	Refraction	6
Luum	Situ	5
Luum	Stimuli	5
Luum	Subdivide	6
Luum	Substance	6
Luum	Superspun	5
Luum	Thangka	8
Luum	Two Tone	7
Luum	Vector	6
Luum	Velvet Underground	6
Luum	Vital	7

MAHARAM		
Manufacturer	Pattern	Grade
Maharam	Abacus	6
Maharam	Abacus Standard	5
Maharam	Across	6
Maharam	Akimbo	6
Maharam	Alloy	6
Maharam	Alter	6
Maharam	Anagram	7

Manufacturer	Pattern	Grade
Maharam	Apt	7
Maharam	Array	6
Maharam	Article	5
Maharam	Banister	6
Maharam	Bar	5
Maharam	Bar Crypton	6
Maharam	Beam	7
Maharam	Beside	6
Maharam	Bevel	5
Maharam	Bitmap	5
Maharam	Blip	7
Maharam	Brio	6
Maharam	Candid	5
Maharam	Caper	5
Maharam	Cartouche	6
Maharam	Centric	7
Maharam	Chance	6
Maharam	Chasm	6
Maharam	Chime	5
Maharam	Chock	6
Maharam	Circuit	6
Maharam	Clamber	6
Maharam	Coin	5
Maharam	Coincide	5
Maharam	Column	6
Maharam	Compound	6
Maharam	Conduit	5
Maharam	Crew	6
Maharam	Crush	6
Maharam	Dapper	5
Maharam	Dart	6
Maharam	Decode	6
Maharam	Disc	5
Maharam	Disc Crypton	6
Maharam	Disperse	6
Maharam	Ditto	7
Maharam	Divide	5
Maharam	Divide Crypton	6
Maharam	Emit	5
Maharam	Emesh	5
Maharam	Exchange	5
Maharam	Fasten	7
Maharam	Fathom	5
Maharam	Feature	6
Maharam	Floret	6
Maharam	Fluent Cryton	6
Maharam	Focus	5
Maharam	Fraction	6
Maharam	Furrow	6
Maharam	Gild	6
Maharam	Grade	7
Maharam	Grove	6
Maharam	Hedge	6
Maharam	Helix	7
Maharam	Insignia	7
Maharam	Instill	5
Maharam	Joist	8
Maharam	Keen	5
Maharam	Kindred	6

Manufacturer	Pattern	Grade	Manufacturer	Pattern	Grade	Manufacturer	Pattern	Grade
Maharam	Knob	Call	Maharam	Tempera	6	Mayer	Comalapa	6
Maharam	Knot	9	Maharam	Tend	6	Mayer	Contempo	3
Maharam	Lariat	5	Maharam	Ticker	6	Mayer	Continuum 10	3
Maharam	Latch	7	Maharam	Tilt	6	Mayer	Cosmopolitan	4
Maharam	Ledger	5	Maharam	Trait	6	Mayer	Counterpoint	5
Maharam	Lens	5	Maharam	Treat	6	Mayer	Crazy Quilt	6
Maharam	Limn	8	Maharam	Trio	8	Mayer	Cross Check	2
Maharam	Lineage	5	Maharam	Trundle	5	Mayer	Cube	3
Maharam	Lunar	5	Maharam	Urban	6	Mayer	Cuddle Up	5
Maharam	Marquee	5	Maharam	Venn	6	Mayer	Curlicue	3
Maharam	Medium	5	Maharam	Wedge	6	Mayer	Dakota	4
Maharam	Medley	5	Maharam	Wend	5	Mayer	Dande	4
Maharam	Meridian	6	Maharam	Whirl	5	Mayer	Darning	6
Maharam	Merit	5	Maharam	Wrap	5	Mayer	Daydream	3
Maharam	Messenger	5				Mayer	Dazzle	5
Maharam	Metric	5				Mayer	Debonair	5
Maharam	Micro	5				Mayer	Debut	6
Maharam	Milestone	5				Mayer	Destiny	3
Maharam	Mineral	6				Mayer	Destiny plus NanoGuard™	4
Maharam	Multiply	5				Mayer	Detail	5
Maharam	Murmur	5				Mayer	Disco	4
Maharam	Oblique	5				Mayer	Dublin Tweed FR	4
Maharam	Offset	7				Mayer	Durango	3
Maharam	Omen	6				Mayer	Duraweave® 10	1
Maharam	Orbit	5				Mayer	Echo	4
Maharam	Parquet	7				Mayer	Ecosphere	5
Maharam	Pennant	6				Mayer	Element	3
Maharam	Pick	5				Mayer	Elevation	5
Maharam	Pick Crypton	6				Mayer	Engrave	3
Maharam	Plait	5				Mayer	Entourage	6
Maharam	Pocket	6				Mayer	Entwine	4
Maharam	Prime	6				Mayer	Ephesus	5
Maharam	Quay	6				Mayer	Equation	4
Maharam	Quick	5				Mayer	Esprit	4
Maharam	Radiant	8				Mayer	Essence	5
Maharam	Reel	7				Mayer	Etch	3
Maharam	Runner	6				Mayer	Europa	4
Maharam	Runner Standard	5				Mayer	Evolve	6
Maharam	Salon	9				Mayer	Facets	5
Maharam	Scape	7				Mayer	Fairy Tales	6
Maharam	Schema	6				Mayer	FanFare	6
Maharam	Scuba	6				Mayer	Fedora	3
Maharam	Scute	5				Mayer	Fiji	2
Maharam	Scuttle	6				Mayer	Finale	5
Maharam	Seam	5				Mayer	Finesse	3
Maharam	Serif	7				Mayer	Florentino	3
Maharam	Serried	7				Mayer	Flower Power	3
Maharam	Sheen	6				Mayer	Form	5
Maharam	Slant	6				Mayer	Forte	1
Maharam	Sort	5				Mayer	Foundation 10	2
Maharam	Span	6				Mayer	Fretwork	6
Maharam	Stature	5				Mayer	Function	4
Maharam	Steady	5				Mayer	Gala	5
Maharam	Steady Crypton	6				Mayer	Galveston	4
Maharam	Stride	6				Mayer	Geisha	7
Maharam	Strum	6				Mayer	Gem	3
Maharam	Sudden	6				Mayer	Genesis	3
Maharam	Surge	6				Mayer	Genesis plus NanoGuard™	4
Maharam	Tailor	5				Mayer	Gravity	6

<b>MAYER</b>		
Manufacturer	Pattern	Grade
Mayer	Abbey	5
Mayer	Abstract	5
Mayer	Acclaim	5
Mayer	Acuco	6
Mayer	Align	3
Mayer	All Seasons FR	3
Mayer	Amadeus	6
Mayer	Ankara	5
Mayer	Antique	4
Mayer	Apex	3
Mayer	Apollo Silicone	6
Mayer	Arabesque	4
Mayer	Aristocrat	4
Mayer	Array	4
Mayer	Ascension	5
Mayer	Atomic	3
Mayer	Aurora	6
Mayer	Avenue	5
Mayer	Balance	5
Mayer	Bali	3
Mayer	Batik	3
Mayer	Berkshire	5
Mayer	Big Top	5
Mayer	Bolero	5
Mayer	Boro	6
Mayer	Botanica	5
Mayer	Botany	5
Mayer	Boteh	7
Mayer	Caressa FR	3
Mayer	Cascade	5
Mayer	Catwalk	4
Mayer	Celtic	4
Mayer	Chaps FR	4
Mayer	Charette	3
Mayer	Chequers	5
Mayer	Circuit	6
Mayer	Circumference	6
Mayer	Cirque	4
Mayer	Collage	6

# Graded In Fabrics

Manufacturer	Pattern	Grade	Manufacturer	Pattern	Grade	Manufacturer	Pattern	Grade
Mayer	Groundworks	5	Mayer	Mosaic plus NanoGuard™	4	Mayer	Sketch	4
Mayer	Haarlem	6	Mayer	Neo	5	Mayer	Slick	4
Mayer	Haberdash	3	Mayer	Niche	5	Mayer	Social Network	5
Mayer	Habitat	4	Mayer	Nirvana	6	Mayer	Soho	5
Mayer	Havana	3	Mayer	Noble	3	Mayer	Soleil	6
Mayer	Hexagon	4	Mayer	Nostalgia	5	Mayer	Sophisticate	4
Mayer	Holiday	5	Mayer	Nylon-Stat ESD	5	Mayer	Source	4
Mayer	Hombre	5	Mayer	Obi	6	Mayer	Source plus NanoGuard™	5
Mayer	Hoopla	2	Mayer	Obsession	6	Mayer	Spacer Mesh	2
Mayer	Huipil	6	Mayer	Odessa	5	Mayer	Splendor	5
Mayer	Images	3	Mayer	Optic 10	3	Mayer	Spokes	6
Mayer	Imprint	3	Mayer	Orbit	3	Mayer	Static	6
Mayer	Infinity	5	Mayer	Origami	6	Mayer	Stellar	3
Mayer	Interlace	4	Mayer	Outback	3	Mayer	Sula	7
Mayer	Interlochen	4	Mayer	Oxen SP Black	1	Mayer	Suna	6
Mayer	Intrigue	4	Mayer	Palermo	5	Mayer	Sutra	6
Mayer	Jekyll & Hyde	4	Mayer	Paparazzi	6	Mayer	Sydney	2
Mayer	Jitterbug	4	Mayer	Parallel	3	Mayer	Synapse	6
Mayer	Jive	2	Mayer	Pastime	5	Mayer	Tango	2
Mayer	Journey	4	Mayer	Patio	3	Mayer	Tattersall	5
Mayer	Jubilee	3	Mayer	Peerless	4	Mayer	Textura	6
Mayer	Kantha	6	Mayer	Phoenix	4	Mayer	Theory 10	3
Mayer	Karma	5	Mayer	Plaza	5	Mayer	Time Line	5
Mayer	Katagami	6	Mayer	Polygon	4	Mayer	Turnabout	6
Mayer	Kensington	5	Mayer	Portal	4	Mayer	Tussah	4
Mayer	Key Largo	3	Mayer	Positive Thoughts	6	Mayer	Valet	3
Mayer	Kobe	3	Mayer	Primo	5	Mayer	Variant 10	3
Mayer	Labyrinth	6	Mayer	Prism 10	3	Mayer	Vector	6
Mayer	Landscape	5	Mayer	Proportion	5	Mayer	Venetian	8
Mayer	Laredo	5	Mayer	Puno	6	Mayer	Venue	4
Mayer	Laser	3	Mayer	Quattro	2	Mayer	Verona	4
Mayer	Latitude	5	Mayer	Rain Dance	4	Mayer	Vibrant	5
Mayer	Lavish	4	Mayer	Ranchero	1	Mayer	Viewpoint	6
Mayer	Links	4	Mayer	Reflector	6	Mayer	Villa	5
Mayer	Locomotion	2	Mayer	Refuge	5	Mayer	Vintage Mohair	Call
Mayer	London	5	Mayer	Rejuvenate	6	Mayer	Vinyl Stat ESD	5
Mayer	Longhorn	5	Mayer	Relativity	6	Mayer	Vipassana	6
Mayer	Longitude	5	Mayer	Replay	5	Mayer	Vogue	4
Mayer	Lotus	6	Mayer	Reveal	5	Mayer	Volante	8
Mayer	Madras	3	Mayer	Reverb	3	Mayer	Wallaby SP Black	1
Mayer	Madrid SP Black	1	Mayer	Rift	5	Mayer	Whimsy	6
Mayer	Malibu	5	Mayer	Round 'N Round	5	Mayer	Whirligig	6
Mayer	Mandala	7	Mayer	Rumba	1	Mayer	Wildflower	6
Mayer	Matka	4	Mayer	Sakura	6	Mayer	Wilson	6
Mayer	Matrix	6	Mayer	Samba	2	Mayer	Wool Boucle	7
Mayer	Matter	5	Mayer	Samurai	6	Mayer	Wool Felt	5
Mayer	Maverick	3	Mayer	Saori	6	Mayer	Wool Heather	5
Mayer	Mayfair	5	Mayer	Score	5	Mayer	Xanadu	6
Mayer	Meander	3	Mayer	Sequel	2	Mayer	Zazen	6
Mayer	Metal Strips	6	Mayer	Sequel plus NanoGuard™	4	Mayer	Zen	6
Mayer	Microdot	3	Mayer	Sequence	4			
Mayer	Milagro	6	Mayer	Shantung	3			
Mayer	Milano	4	Mayer	Sherlock	3			
Mayer	Mingle	4	Mayer	Shibori	6			
Mayer	Mode	5	Mayer	Shimmer	5			
Mayer	Molecule	6	Mayer	Sierra SP Black	1			
Mayer	Monogram	4	Mayer	Signs	6			
Mayer	Moonscape	3	Mayer	Silk Screen	4			
Mayer	Mosaic	3	Mayer	SilverWeave	4			

## MOMENTUM

Manufacturer	Pattern	Grade
Momentum	3D Grid	8
Momentum	Ace	3
Momentum	Acoustic	6

Manufacturer	Pattern	Grade	Manufacturer	Pattern	Grade	Manufacturer	Pattern	Grade
Momentum	Agora II	5	Momentum	Explore	7	Momentum	Odyssey C-Zero	3
Momentum	Aldo	8	Momentum	Expo	2	Momentum	Ohs II	7
Momentum	Allegory	6	Momentum	Faux Felt	5	Momentum	Origin	1
Momentum	Amentiy II	6	Momentum	Fleet	6	Momentum	Painting Strokes	7
Momentum	Amuse	5	Momentum	Float	4	Momentum	Panorama	6
Momentum	April	5	Momentum	Flow	6	Momentum	Parable	6
Momentum	Archer	6	Momentum	Flux	7	Momentum	Parentesi	8
Momentum	Arrange	7	Momentum	Focal	4	Momentum	Paenthesi	3
Momentum	Audubon	7	Momentum	Fold	7	Momentum	Perk	2
Momentum	Bandwidth II	6	Momentum	Foray	5	Momentum	Phonton	6
Momentum	Bangle	2	Momentum	Free	3	Momentum	Phrase	6
Momentum	Banter	7	Momentum	Fuse	2	Momentum	Pierre	8
Momentum	Beeline EPU	3	Momentum	Geo	7	Momentum	Ping	5
Momentum	Beep	4	Momentum	Glide	5	Momentum	Pique	4
Momentum	Bloc	7	Momentum	Graph	2	Momentum	Pip	5
Momentum	Bobby	2	Momentum	Grid	3	Momentum	Places Spaces Faces	7
Momentum	Boom II	5	Momentum	Groove EPU	5	Momentum	Propel	6
Momentum	Boxcar	6	Momentum	Guild	3	Momentum	Propensity II	3
Momentum	Bravo II	5	Momentum	Habit	3	Momentum	Prospect	5
Momentum	Brink	6	Momentum	Halo	6	Momentum	Proximity	7
Momentum	Brisk	6	Momentum	Hearsay	6	Momentum	Pursue	6
Momentum	Buoy	6	Momentum	Helm	6	Momentum	Quince	7
Momentum	Cairns	7	Momentum	Hive	6	Momentum	Rally	6
Momentum	Camber	7	Momentum	Hop	6	Momentum	Refract	6
Momentum	Canter EPU	3	Momentum	Hue	3	Momentum	Rein II	5
Momentum	Carlo	7	Momentum	Icon	5	Momentum	Reveal	7
Momentum	Cashmere II	5	Momentum	Infinity C-Zero	3	Momentum	Revolve	7
Momentum	Centric	6	Momentum	Insight	2	Momentum	Riga	7
Momentum	Chipper	7	Momentum	Interim	6	Momentum	Ring	6
Momentum	Chromatic	6	Momentum	Interlock	8	Momentum	Rise	4
Momentum	Cityscape	7	Momentum	Intermix II	5	Momentum	Rivet	4
Momentum	Clang	4	Momentum	Jitney	6	Momentum	Row	5
Momentum	Colorwheel	6	Momentum	Jot	4	Momentum	Rubato	6
Momentum	Course	6	Momentum	Journal	7	Momentum	Rush Hour	7
Momentum	Cover Cloth	4	Momentum	Kindle	5	Momentum	Sail	6
Momentum	Croquet	7	Momentum	Kindred	6	Momentum	Scan	6
Momentum	Crossing Colors	7	Momentum	Kinney	5	Momentum	Scrabble	4
Momentum	Cryptic	6	Momentum	Knack	3	Momentum	Sidestep	6
Momentum	Cube	6	Momentum	Ledge	5	Momentum	Silica	7
Momentum	Current	3	Momentum	Lella	7	Momentum	Silica Leather	7
Momentum	Cutout	8	Momentum	Lens	4	Momentum	Site Line	8
Momentum	Cycle	5	Momentum	Leno	7	Momentum	Sketching Air	7
Momentum	Dart	3	Momentum	Level	6	Momentum	Skip	4
Momentum	Dash	6	Momentum	Lina	7	Momentum	Slice	2
Momentum	Dayspell	6	Momentum	Lineup	3	Momentum	Small Talk	6
Momentum	Decode	3	Momentum	Llyod	7	Momentum	Solace	4
Momentum	Delve	6	Momentum	Lore	7	Momentum	Sort	6
Momentum	Dive	6	Momentum	Lucio	9	Momentum	Sport	5
Momentum	Drawing Lines	7	Momentum	Ludwig	7	Momentum	Spontaneous	7
Momentum	Drift	6	Momentum	Malmo	7	Momentum	Starboard	6
Momentum	Ebb	7	Momentum	Mapping Ideas	7	Momentum	Story	6
Momentum	Echo II	6	Momentum	Marathon C-Zero	3	Momentum	Stroll	4
Momentum	Edison	6	Momentum	Marcel	7	Momentum	Strut	5
Momentum	Embark	6	Momentum	Memory	7	Momentum	Sublime II	5
Momentum	Endurance EPU	4	Momentum	Millennium C-Zero	3	Momentum	Symbol	7
Momentum	Eon EPU	4	Momentum	Mix	6	Momentum	Syntax	3
Momentum	Epic	3	Momentum	Nagoya	7	Momentum	Tack	5
Momentum	Essay	6	Momentum	Nifty	5	Momentum	Tact II	6
Momentum	Estrella	7	Momentum	Nimble	7	Momentum	Tactic	7

# Graded In Fabrics

Manufacturer	Pattern	Grade
Momentum	Tesla	6
Momentum	Tetra	4
Momentum	Tilt	6
Momentum	Toggle	3
Momentum	Traction	7
Momentum	Tradition C-Zero	3
Momentum	Trapeze	7
Momentum	Trivia	7
Momentum	Trove	7
Momentum	Turin	7
Momentum	Twist	7
Momentum	Uplift	6
Momentum	Veer	6
Momentum	Velocity	5
Momentum	Via	3
Momentum	Viva II	6
Momentum	Vox	3
Momentum	Wander	6
Momentum	Waver	5
Momentum	Weaving Palettes	6
Momentum	Well Well Well	8
Momentum	Whim	6
Momentum	Whit EPU	5
Momentum	Why Why Why	7
Momentum	Zipped	7

## PAUL BRAYTON

Manufacturer	Pattern	Grade
Paul Brayton	Al Fresco	6
Paul Brayton	Almost Textura w/ Healthguard	7
Paul Brayton	Alpine	7
Paul Brayton	Angus	6
Paul Brayton	Backgammon	6
Paul Brayton	Canopy	6
Paul Brayton	Cirrus	6
Paul Brayton	Divine	4
Paul Brayton	Flannelsuede - 3100	9
Paul Brayton	Flannelsuede - 3103	9
Paul Brayton	Frolic	6
Paul Brayton	Fun	6
Paul Brayton	Jilly Twill	4
Paul Brayton	Journey	6
Paul Brayton	Killian	6
Paul Brayton	Meridian	5
Paul Brayton	Molly	6
Paul Brayton	Moonstruck	6
Paul Brayton	Nimbus	6
Paul Brayton	Odyssey	7
Paul Brayton	Pizzelle	6
Paul Brayton	Prizm	7
Paul Brayton	Promenade	6
Paul Brayton	Quest	6
Paul Brayton	Rhyme	4
Paul Brayton	Somerfield	6
Paul Brayton	Spinnaker	7

Manufacturer	Pattern	Grade
Paul Brayton	Stratus	6
Paul Brayton	Tiki	6
Paul Brayton	Toto Plaid	6
Paul Brayton	Tulip	6
Paul Brayton	Woodland	7

## ULTRAFABRICS

Manufacturer	Pattern	Grade
Ultrafabrics	Brisa	5
Ultrafabrics	Brisa Indoor/Outdoor	6
Ultrafabrics	Brisa Distressed	5
Ultrafabrics	Brisa Distressed Indoor/Outdoor	6
Ultrafabrics	Brisa Fresco	5
Ultrafabrics	Brisa Mokume	5
Ultrafabrics	Cora	5
Ultrafabrics	Cove	5
Ultrafabrics	Dwell	5
Ultrafabrics	Eco Tech	5
Ultrafabrics	Fusion	5
Ultrafabrics	Fusion Shimmer	5
Ultrafabrics	Helix	5
Ultrafabrics	Linen	5
Ultrafabrics	Pony	5
Ultrafabrics	Primera	3
Ultrafabrics	Promessa	5
Ultrafabrics	Promessa Indoor/Outdoor	5
Ultrafabrics	Strada	4
Ultrafabrics	Toscana	4
Ultrafabrics	Uccello	5
Ultrafabrics	Ultraleather	5
Ultrafabrics	Ultraleather Pearlized	5
Ultrafabrics	Ultraleather Pro	5
Ultrafabrics	Ultraleather Tottori	5
Ultrafabrics	Ultratech Wired	5
Ultrafabrics	Viva	5

## CTL LEATHER

Manufacturer	Pattern	Grade
CTL Leather	Atlantic	Call
CTL Leather	Barolo	Call
CTL Leather	Bull Soft	Call
CTL Leather	Capri	Call
CTL Leather	Caress	Call
CTL Leather	Classico	Call
CTL Leather	Cowboy	Call
CTL Leather	Dakota	Call
CTL Leather	Dallas Soft (New Colours)	Call
CTL Leather	Dublin	Call
CTL Leather	Elegance	Call
CTL Leather	Epic (NEW)	Call
CTL Leather	Heritage	Call
CTL Leather	Linea	Call
CTL Leather	Lodge (New Colours)	Call
CTL Leather	Madras (New Colours)	Call
CTL Leather	Mardi Gras	Call
CTL Leather	Mustang (NEW)	Call
CTL Leather	Palma (New Colours)	Call
CTL Leather	Paradiso	Call
CTL Leather	Prescott	Call
CTL Leather	Queensland (NEW)	Call
CTL Leather	Rio (New Colours)	Call
CTL Leather	Roxy	Call
CTL Leather	Santiago	Call
CTL Leather	Seide	Call
CTL Leather	Siena	Call
CTL Leather	Stagecoach	Call
CTL Leather	Tuscania (New Colours)	Call
CTL Leather	Valencia	Call
CTL Leather	Vogue	Call





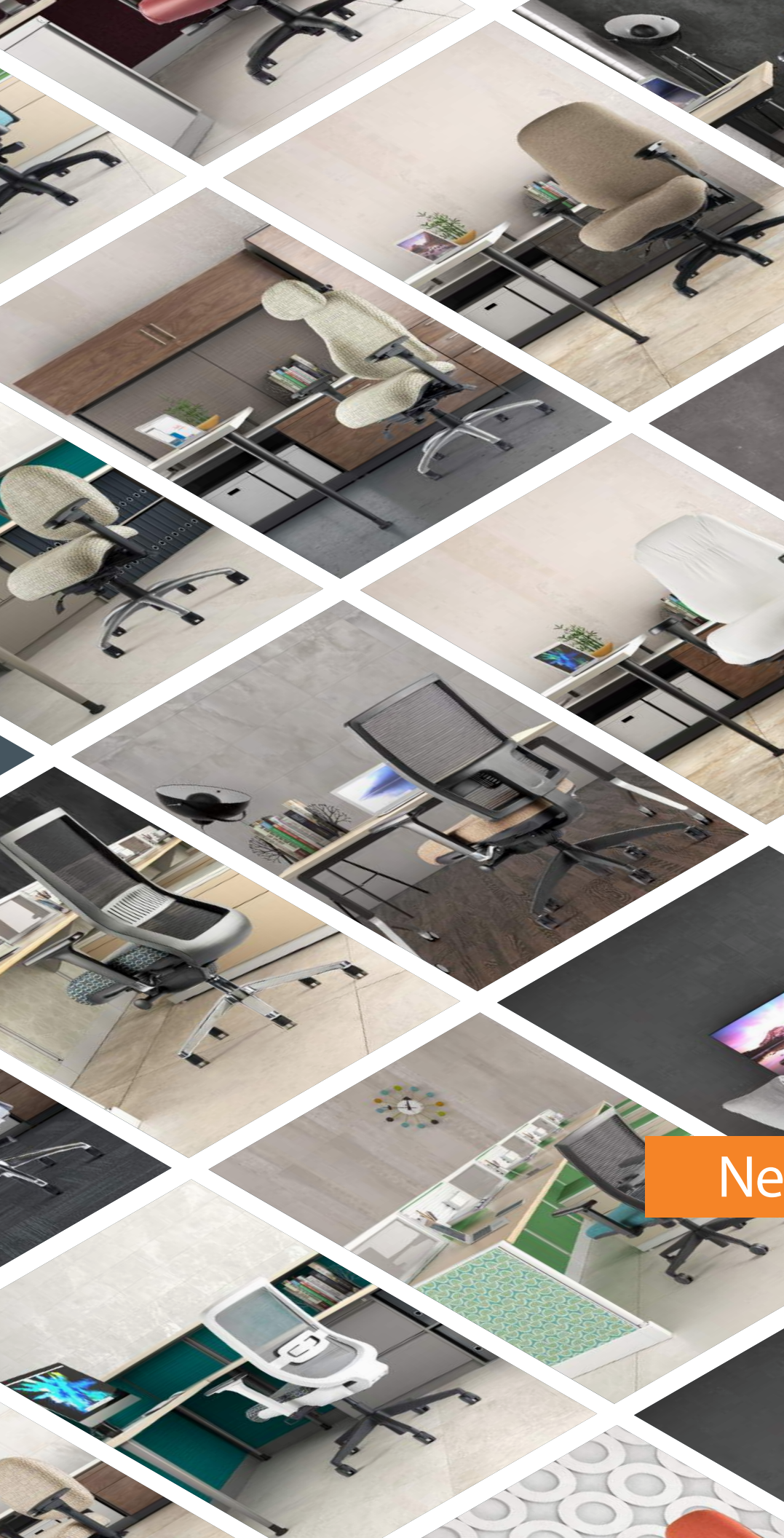

NeutralPosture.com  
3904 N. Texas Ave.  
Bryan, TX 77803  
T 979.778.0502  
F 979.778.0408

# NeutralPosture

GSA  
SCS Indoor Advantage  
BIFMA e3/LEVEL  
ISO 9001:2008 Approved

