



NeutralPosture

Equity^{NP}[®]

LEGACY

TABLE OF CONTENTS

EQUITY LEGACY FINISHES	2	SELLING POLICY	26
Laminates	2	TERMS AND CONDITIONS	26
Worksurface Edge	2	Ordering	26
Painted Trim	2	Prices	26
Insert Options	3	Taxes	26
Fabrics	3	Lead Time	26
Customer's Own Material	3	Storage Fee	26
PANELS	4	Shipping	26
Gen 1 Fabric Panels 28" – 48" High	4	Freight Damage	27
Gen 1 Fabric Panels 53" – 80" High	5	Returns	27
Gen 2 Insert Panels 28" – 53" High	6	Warranty Claims	27
Gen 2 Insert Panels 60" – 80" High	7	Customer's Own Materials	27
Wall Starter & Wall Mount Chanel	8	Delay/Force Majeure	27
POST ASSEMBLIES	9	Compliance with Law	27
Straight	9	Warranty	28
Corner (90°)	9	General Information	28
End	9	SUSTAINABLE DESIGN	29
3-way (T)	10	Green Manufacturing Process	29
3-way (Y)	10	Green Shipping Initiatives	29
4-way (X)	10	Packaging Options	29
Dual Height Posts	11	A Long and Healthy Product Life	29
Triple Height Posts	12	KEY LOCK PROGRAM	30
Single Height Posts	13	General Information	30
Gen 1 Panel Connectors	14	How to Specify Key Alike	30
Gen 1 Panel Extender Kit	15	Key-alike ordered prior to 6/12/00	31
ELECTRIAL	16		
Dedicated Neutral System Components	16		
Dedicated Neutral Jumpers	17		
PANEL ACCESSORIES	18		
Vertical Wire Manager	18		
Metal Ceiling Module	18		
Coat Hook	19		
Carpet Gripper	19		
COUNTER CAPS	20		
Straights	20		
Corners	21		
WALL MOUNTING	24		
Wall Mounting Suggestions	25		

Equity Legacy Finishes

LAMINATES

111	Jet Black
114	Folkstone Grey (was LA)
117	Soft Grey (was M42)
118	Bright White
119	Pumice (was LF)
121	Micro Grey
122	Brushed Sand
123	Brushed Grey
124	Medium Cherry
125	Natural Maple
126	Natural Cherry
127	Walnut
128	Fog
129	Micro Sand
MC	Caramel Maple
CM	Clear Maple
MP58	Deep Mahogany
M95	Grey Granite
M1	Light Grey
MP70	Light Oak
CP276	Markerboard
PA	Pearwood
M96	Rose Granite
SD	Sand
M89	Med. Grey (Slate)
B	Snow
M80	Taupe
WM	Warm Cherry
ES7	White Essence
MR6	Winter Grey Matrix

WORKSURFACE EDGE

111	Jet Black
113	Dark Grey (was Y3)
114	Folkstone Grey (was LA)
115	Medium Grey (was Y2)
117	Soft Grey (was E)
118	Bright White
119	Pumice (was LF)
124	Medium Cherry
125	Natural Maple
126	Natural Cherry
127	Walnut
128	Fog
D	Dark Neutral
B	Snow
R	Taupe
SD	Sand
MC	Caramel Maple
CM	Clear Maple
WM	Warm Cherry

PAINTED TRIM

P1 FINISHES

111	Jet Black
112	Brown
113	Dark Grey (was Y3)
114	Folkstone Grey (was LA)
115	Med. Grey (was Y2)
116	Sandstone
117	Soft Grey (was E)
D	Dark Neutral
R	Taupe

P2 FINISHES

611	Beige Mist Metallic
612	Medium Metallic Grey
H	Beige Metallic
W	Light Tan Metallic

P3 FINISHES

118	Bright White
613	Silver

NOTE: EP1 and EP2 panels and components are not available in the following:

111	Jet Black
112	Brown
118	Bright White

NOTE: Laminates and other finishes may vary in color due to different dye lots. Slight variations are normal.

NOTE: Specify Legacy finishes to match existing product only. Legacy finishes are not available for new customers.

INSERT OPTIONS

for insert panels, stack-on panels and add-on screens.

PLEXIGLASS

CL	Clear
IC	Ice
SM	Smoked
TR	Translucent

LUMASITE

(stack-on panels and add-on screens only)

LF	Frost
----	-------

FABRICS

GRADE 10

Annex	W1360
Foundation	W351
Growth Spurt	W692
Symbolic Detail	W693
Versatility	W432

GRADE 20

Bauhaus Block	W296
Circle Line	W1146
Criss Cross	W305
Nematic	W1292
Photon	W1293
Reflect	W884
Weave Three	W298

GRADE 30

Basket Draft	W249
Flow	W565
Harmony	W232
Micro	W465
Relay	W1020

GRADE 40

Amplify	W1215
Foil Rap	W535
Hard Rock	W1007
Heavy Metal	W539
Metaphor	K612

NOTE: All 72 privacy screens require that the textile is railroaded (turned 90 degrees) for application. This must be considered when applying a patterned textile.

CUSTOMER'S OWN MATERIAL

Customer's Own Material (COM) can be applied to Equity products on a select basis. Please consult your Neutral Posture Customer Service Representative for details on the COM approval process and testing requirements.

Pricing for COM fabrics is at Grade 10.

NOTE: Always contact your Customer Service Representative prior to sending any COM (including pre-approved textiles) to the manufacturing facility.

Generation 1 Fabric Panel

28" thru 48" High



28" High

W	PATTERN NO.	10	20	25	30	35	40	45	ADD FOR P2	ADD FOR P3
12"	EP1FA1228R	\$654	\$706	\$722	\$739	\$752	\$765	\$784	N/A	\$50
18"	EP1FA1828R	681	735	749	767	779	797	815	N/A	50
24"	EP1FA2428R	705	763	776	798	811	825	849	N/A	50
30"	EP1FA3028R	726	780	798	819	835	850	872	N/A	50
36"	EP1FA3628R	759	818	834	855	873	886	910	N/A	50
42"	EP1FA4228R	792	853	872	894	912	925	947	N/A	50
48"	EP1FA4828R	820	887	901	927	944	961	986	N/A	50
60"	EP1FA6028R	874	941	960	988	1,004	1,019	1,047	N/A	50

40" High

12"	EP1FA1240R	687	740	756	776	789	804	821	N/A	50
18"	EP1FA1840R	720	776	792	811	825	840	860	N/A	50
24"	EP1FA2440R	752	811	827	851	865	881	901	N/A	50
30"	EP1FA3040R	775	838	852	877	892	907	929	N/A	50
36"	EP1FA3640R	800	865	881	904	922	936	961	N/A	50
42"	EP1FA4240R	893	962	982	1,007	1,027	1,043	1,073	N/A	50
48"	EP1FA4840R	921	995	1,010	1,039	1,056	1,076	1,101	N/A	50
60"	EP1FA6040R	1,034	1,117	1,136	1,168	1,189	1,208	1,242	N/A	50

48" High

12"	EP1FA1248R	706	764	777	799	812	827	850	N/A	50
18"	EP1FA1848R	741	801	815	839	853	872	892	N/A	50
24"	EP1FA2448R	812	879	895	912	935	953	973	N/A	50
30"	EP1FA3048R	836	901	921	944	961	978	1,004	N/A	50
36"	EP1FA3648R	848	915	930	956	970	989	1,014	N/A	50
42"	EP1FA4248R	941	1,016	1,037	1,063	1,083	1,101	1,130	N/A	50
48"	EP1FA4848R	1,004	1,083	1,101	1,133	1,154	1,173	1,204	N/A	50
60"	EP1FA6048R	1,141	1,235	1,256	1,288	1,312	1,335	1,370	N/A	50

Order Code	
e.g.	EP1FA3648R, W3513, 117
EP1FA	Fabric panel
36	Width
48	Height
R	Raceway
W351-3	Foundation, Corn Silk
117	Soft Grey trim

Specification Information	
Specify fabric and trim color. Post assemblies or connection elements must be ordered separately.	Pricing listed above is for P1 trim colors. Add the appropriate upcharge if using P2 or P3 trim colors.
NOTE: Power duplexes cannot be installed on 12" W panels. Side mount receptacles available in 24" W panels and wider while using "E" series power.	NOTE: P2 trim colors are not available on EP1 panels and panel components.
Electrical components must be ordered separately.	

Application Notes
Panel is fabric covered. If two different fabrics are used on one panel, price will reflect cost of the more expensive panel fabric.
NOTE: EP1 & EP2 Panels and components are available in legacy colors only.

Generation 1 fabric panel

53" thru 80" High



53" High

W	PATTERN NO	10	20	25	30	35	40	45	ADD FOR P2	ADD FOR P3
12"	EP1FA1253R	\$724	\$778	\$796	\$814	\$829	\$844	\$868	N/A	\$50
18"	EP1FA1853R	760	819	835	856	874	887	912	N/A	50
24"	EP1FA2453R	801	868	884	907	923	937	962	N/A	50
30"	EP1FA3053R	821	889	904	930	946	962	988	N/A	50
36"	EP1FA3653R	946	1,021	1,042	1,073	1,088	1,109	1,136	N/A	50
42"	EP1FA4253R	989	1,069	1,088	1,118	1,136	1,158	1,187	N/A	50
48"	EP1FA4853R	1,045	1,129	1,150	1,182	1,202	1,222	1,254	N/A	50
60"	EP1FA6053R	1,187	1,282	1,305	1,340	1,365	1,389	1,424	N/A	50

60" High

12"	EP1FA1260R	740	800	814	838	852	868	889	N/A	50
18"	EP1FA1860R	784	849	863	886	899	918	941	N/A	50
24"	EP1FA2460R	800	865	881	904	922	936	961	N/A	50
30"	EP1FA3060R	885	956	970	1,002	1,016	1,036	1,058	N/A	50
36"	EP1FA3660R	966	1,043	1,061	1,091	1,113	1,130	1,160	N/A	50
42"	EP1FA4260R	1,053	1,136	1,160	1,190	1,209	1,231	1,263	N/A	50
48"	EP1FA4860R	1,137	1,230	1,251	1,285	1,308	1,330	1,368	N/A	50
60"	EP1FA6060R	1,307	1,413	1,438	1,477	1,503	1,529	1,569	N/A	50

65" High

12"	EP1FA1265R	779	844	858	884	897	916	936	N/A	50
18"	EP1FA1865R	799	862	880	901	921	933	959	N/A	50
24"	EP1FA2465R	895	967	986	1,010	1,032	1,047	1,075	N/A	50
30"	EP1FA3065R	947	1,024	1,043	1,074	1,091	1,110	1,137	N/A	50
36"	EP1FA3665R	1,007	1,088	1,110	1,138	1,160	1,179	1,208	N/A	50
42"	EP1FA4265R	1,098	1,189	1,208	1,243	1,264	1,285	1,321	N/A	50
48"	EP1FA4865R	1,190	1,284	1,308	1,343	1,369	1,393	1,428	N/A	50
60"	EP1FA6065R	1,374	1,483	1,513	1,554	1,579	1,608	1,650	N/A	50

80" High

12"	EP1FA1280R	795	855	873	895	913	927	953	N/A	50
18"	EP1FA1880R	844	913	929	955	969	988	1,012	N/A	50
24"	EP1FA2480R	899	971	992	1,018	1,037	1,054	1,080	N/A	50
30"	EP1FA3080R	1,010	1,091	1,115	1,143	1,163	1,183	1,212	N/A	50
36"	EP1FA3680R	1,128	1,215	1,240	1,276	1,297	1,319	1,352	N/A	50
42"	EP1FA4280R	1,242	1,340	1,365	1,401	1,428	1,452	1,488	N/A	50
48"	EP1FA4880R	1,352	1,460	1,486	1,528	1,555	1,581	1,621	N/A	50
60"	EP1FA6080R	1,577	1,701	1,734	1,782	1,814	1,844	1,893	N/A	50

Order Code

e.g.	EP1FA2460R, W3513, 117
EP1FA	Fabric panel
24	Width
60	Height
W351-3	Foundation, Corn Silk
117	Soft Grey trim

Specification Information

Specify fabric and trim color. Post assemblies or connection elements must be ordered separately.

NOTE: Power duplexes cannot be installed on 12" W panels. Side mount receptacles available in 24" W panels and wider while using "E" series power.

Electrical components must be ordered separately.

Pricing listed above is for P1 trim colors. Add the appropriate upcharge if using P2 or P3 trim colors.

NOTE: P2 trim colors are not available on EP1 panels and panel components.

Application Notes

Panel is fabric covered. If two different fabrics are used on one panel, price will reflect cost of the more expensive panel fabric.

NOTE: EP1 & EP2 Panels and components are available in legacy colors only.

Generation 2 Insert Panel

(compatible with generation 1 panel components only)



28" High

W	PATTERN NO	OPEN FRAME (OF)	PLEXIGLASS (PG)*	ADD FOR P2	ADD FOR P3
12"	EP2()1228R	\$697	\$936	N/A	\$50
18"	EP2()1828R	711	1,004	N/A	50
24"	EP2()2428R	725	1,058	N/A	50
30"	EP2()3028R	740	1,121	N/A	50
36"	EP2()3628R	759	1,174	N/A	50
42"	EP2()4228R	778	1,269	N/A	50
48"	EP2()4828R	797	1,293	N/A	50
60"	EP2()6028R	834	1,408	N/A	50

40" High

12"	EP2()1240R	736	1,028	N/A	50
18"	EP2()1840R	751	1,090	N/A	50
24"	EP2()2440R	763	1,154	N/A	50
30"	EP2()3040R	779	1,270	N/A	50
36"	EP2()3640R	797	1,430	N/A	50
42"	EP2()4240R	818	1,460	N/A	50
48"	EP2()4840R	836	1,481	N/A	50
60"	EP2()6040R	874	1,632	N/A	50

48" High

12"	EP2()1248R	751	1,057	N/A	50
18"	EP2()1848R	766	1,165	N/A	50
24"	EP2()2448R	777	1,248	N/A	50
30"	EP2()3048R	797	1,359	N/A	50
36"	EP2()3648R	811	1,382	N/A	50
42"	EP2()4248R	834	1,522	N/A	50
48"	EP2()4848R	852	1,802	N/A	50
60"	EP2()6048R	887	1,821	N/A	50

53" High

12"	EP2()1253R	776	1,091	N/A	50
18"	EP2()1853R	792	1,197	N/A	50
24"	EP2()2453R	800	1,279	N/A	50
30"	EP2()3053R	820	1,393	N/A	50
36"	EP2()3653R	836	1,484	N/A	50
42"	EP2()4253R	857	1,648	N/A	50
48"	EP2()4853R	877	1,669	N/A	50
60"	EP2()6053R	915	1,854	N/A	50

* All Colors

Order Code	
e.g.	EP2PG3648R, PC, 613
EP2PG	Plexiglass Insert Panel
36	Width
48	Height
R	Raceway
PC	Clear
613	Silver trim

Specification Information

Specify insert type, insert color and trim color.

Pricing listed above is for P1 trim colors. Add the appropriate upcharge if using P2 or P3 trim colors.

Application Notes

Top caps and base raceway covers are included with panels. Posts and panel connectors must be ordered separately.

NOTE: P2 trim colors are not available on EP2 panels or panel components.

Generation 2 insert panels incorporate the generation 3 mitered panel frame with generation 1 top caps and base raceway covers and will only work with generation 1 panels and panel components.

NOTE: EP1 & EP2 Panels and components are available in legacy colors only.

Generation 2 Insert Panel

(compatible with generation 1 panel components only)



60" High

W	PATTERN NO	OPEN FRAME (OF)	PLEXIGLASS (PG)*	ADD FOR P2	ADD FOR P3
12"	EP2()1260R	\$784	\$1,129	N/A	\$50
18"	EP2()1860R	799	1,251	N/A	50
24"	EP2()2460R	810	1,379	N/A	50
30"	EP2()3060R	827	1,518	N/A	50
36"	EP2()3660R	844	1,539	N/A	50
42"	EP2()4260R	868	1,679	N/A	50
48"	EP2()4860R	884	1,816	N/A	50
60"	EP2()6060R	921	2,036	N/A	50

65" High

12"	EP2()1265R	797	1,143	N/A	50
18"	EP2()1865R	811	1,267	N/A	50
24"	EP2()2465R	821	1,413	N/A	50
30"	EP2()3065R	839	1,535	N/A	50
36"	EP2()3665R	857	1,555	N/A	50
42"	EP2()4265R	879	1,695	N/A	50
48"	EP2()4865R	895	2,076	N/A	50
60"	EP2()6065R	930	2,115	N/A	50

80" High

12"	EP2()1280R	851	1,304	N/A	50
18"	EP2()1880R	868	1,446	N/A	50
24"	EP2()2480R	877	1,576	N/A	50
30"	EP2()3080R	894	1,825	N/A	50
36"	EP2()3680R	913	1,983	N/A	50
42"	EP2()4280R	930	2,287	N/A	50
48"	EP2()4880R	948	2,308	N/A	50
60"	EP2()6080R	988	2,625	N/A	50

* All Colors

Order Code

e.g. EP2PG2460R, 613

EP2PG Plexiglass Insert Panel

24 Width

60 Height

R Raceway

613 Silver trim

Specification Information

Specify insert type, insert color and trim color.

Pricing listed above is for P1 trim colors. Add the appropriate upcharge if using P2 or P3 trim colors.

Top caps and base raceway covers are included with panels. Posts and panel connectors must be ordered separately.

NOTE: P2 trim colors are not available on EP2 panels or panel components.

Application Notes

Generation 2 insert panels incorporate the generation 3 mitered panel frame with generation 1 top caps and base raceway covers and will only work with generation 1 panels and panel components.

NOTE: EP1 & EP2 Panels and components are available in legacy colors only.

Generation 1

wall starter and wall mount channel

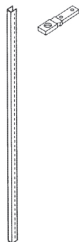

Panel Wall Starter

W	D	H*	ACTUAL HEIGHT	PATTERN NO	P1	P2	P3
1½"	½"	28"	23"	EP1PWS28	\$44	N/A	\$48
1½"	½"	40"	35"	EP1PWS40	44	N/A	48
1½"	½"	48"	43"	EP1PWS48	48	N/A	52
1½"	½"	53"	48"	EP1PWS53	50	N/A	56
1½"	½"	60"	55"	EP1PWS60	50	N/A	56
1½"	½"	65"	60"	EP1PWS65	52	N/A	59
1½"	½"	80"	75"	EP1PWS80	59	N/A	69



Wall Mounted Channel

2⅞"	¾"	28"	23"	EP1WMC28	112	N/A	122
2⅞"	¾"	40"	35"	EP1WMC40	112	N/A	122
2⅞"	¾"	48"	43"	EP1WMC48	114	N/A	124
2⅞"	¾"	53"	48"	EP1WMC53	116	N/A	128
2⅞"	¾"	60"	55"	EP1WMC60	130	N/A	145
2⅞"	¾"	65"	60"	EP1WMC65	133	N/A	150
2⅞"	¾"	80"	75"	EP1WMC80	162	N/A	178
2⅞"	¾"	120"	120"	EP1WMC120	249	N/A	276

* - actual height

Order Code	
e.g. EP1PWS60, 117	
EP1PWS	Panel wall starter
60	Height
117	Soft Grey trim

Specification Information
Specify trim color.
NOTE: Neutral Posture, Inc. assumes no responsibility for wall construction or performance of fasteners used.

Application Notes
<p>Wall starter: Used to start a run of panels by fastening to an existing wall and attaching a connector assembly to it. Creates 1¼" space from face of wall to centerline of post. Constructed of steel.</p> <p>The wall starter includes panel top and bottom hooks and modified panel connector. Fasteners not included to attach to wall.</p> <p>Post and shrouds must</p>
<p>be ordered separately.</p> <p>Wall mount channel: Allows hanging of all components and accessories on reinforced building walls.</p> <p>Painted extruded aluminum with a plastic inset which snaps in place, covering mounting screws.</p> <p>NOTE: EP1 & EP2 Panels and components are available in legacy colors only.</p>

Generation 1

single height post assemblies straight, corner and end



Straight

W	D	H	PATTERN NO	P1	P2	P3
-	-	28"	EP1P28S	\$148	N/A	\$164
-	-	40"	EP1P40S	150	N/A	165
-	-	48"	EP1P48S	152	N/A	166
-	-	53"	EP1P53S	154	N/A	168
-	-	60"	EP1P60S	156	N/A	170
-	-	65"	EP1P65S	157	N/A	172
-	-	80"	EP1P80S	161	N/A	177



Corner (90°)

-	-	28"	EP1P28L	144	N/A	156
-	-	40"	EP1P40L	145	N/A	157
-	-	48"	EP1P48L	146	N/A	161
-	-	53"	EP1P53L	148	N/A	164
-	-	60"	EP1P60L	150	N/A	165
-	-	65"	EP1P65L	152	N/A	166
-	-	80"	EP1P80L	156	N/A	170



End

-	-	28"	EP1P28E	157	N/A	172
-	-	40"	EP1P40E	159	N/A	174
-	-	48"	EP1P48E	161	N/A	177
-	-	53"	EP1P53E	162	N/A	178
-	-	60"	EP1P60E	164	N/A	179
-	-	65"	EP1P65E	165	N/A	183
-	-	80"	EP1P80E	167	N/A	187

Order Code

e.g.	EP1P48S, 117
EP1P	Post
48	Height
S	Straight assembly
117	Soft Grey trim

Specification Information

Specify trim color.
Specify fabric color (if post covers are specified).

Application Notes

Used to connect panels of the same height.
Kit includes single height post, post plug, panel connector and base raceway shroud(s) appropriate for the geometry specified.

NOTE: EP1 & EP2 Panels and components are available in legacy colors only.
Bottom levelers on post allow for up to 1½" vertical adjustment.

Generation 1

single height post assemblies three and four way



3-way (T)

W	D	H	PATTERN NO	P1	P2	P3
-	-	28"	EP1P28T	\$144	N/A	\$156
-	-	40"	EP1P40T	145	N/A	157
-	-	48"	EP1P48T	146	N/A	161
-	-	53"	EP1P53T	148	N/A	164
-	-	60"	EP1P60T	150	N/A	165
-	-	65"	EP1P65T	152	N/A	166
-	-	80"	EP1P80T	156	N/A	170



3-way (Y)

-	-	28"	EP1P28Y	179	N/A	201
-	-	40"	EP1P40Y	183	N/A	202
-	-	48"	EP1P48Y	185	N/A	203
-	-	53"	EP1P53Y	186	N/A	205
-	-	60"	EP1P60Y	187	N/A	206
-	-	65"	EP1P65Y	190	N/A	208
-	-	80"	EP1P80Y	192	N/A	208



4-way (X)

-	-	28"	EP1P28X	124	N/A	136
-	-	40"	EP1P40X	128	N/A	141
-	-	48"	EP1P48X	129	N/A	144
-	-	53"	EP1P53X	130	N/A	145
-	-	60"	EP1P60X	131	N/A	146
-	-	65"	EP1P65X	132	N/A	147
-	-	80"	EP1P80X	135	N/A	150

Order Code	
e.g.	EP1P80T, 117
EP1P	Post
80	Height
T	"T" assembly
117	Soft Grey trim

Specification Information
Specify trim color.
Specify fabric color (if post covers are specified).

Application Notes
Used to connect panels of the same height.
Kit includes single height post, post plug, panel connector and base raceway shroud(s) appropriate for the geometry specified.
NOTE: EP1 & EP2 Panels and components are available in legacy colors only.
Bottom levelers on post allow for up to 1½" vertical adjustment.



Dual Height Post

W	D	H	PATTERN NO	P1	P2	P3
-	-	28"/40"	EP1DP2840	\$154	N/A	\$168
-	-	28"/48"	EP1DP2848	164	N/A	179
-	-	28"/53"	EP1DP2853	167	N/A	187
-	-	28"/60"	EP1DP2860	170	N/A	190
-	-	28"/65"	EP1DP2865	177	N/A	193
-	-	28"/80"	EP1DP2880	193	N/A	215
-	-	40"/48"	EP1DP4048	164	N/A	179
-	-	40"/53"	EP1DP4053	167	N/A	187
-	-	40"/60"	EP1DP4060	170	N/A	190
-	-	40"/65"	EP1DP4065	177	N/A	193
-	-	40"/80"	EP1DP4080	193	N/A	215
-	-	48"/53"	EP1DP4853	167	N/A	187
-	-	48"/60"	EP1DP4860	170	N/A	190
-	-	48"/65"	EP1DP4865	177	N/A	193
-	-	48"/80"	EP1DP4880	193	N/A	215
-	-	53"/60"	EP1DP5360	170	N/A	190
-	-	53"/65"	EP1DP5365	177	N/A	193
-	-	53"/80"	EP1DP5380	199	N/A	219
-	-	60"/65"	EP1DP6065	177	N/A	193
-	-	60"/80"	EP1DP6080	193	N/A	215
-	-	65"/80"	EP1DP6580	193	N/A	215

Order Code	
e.g.	EP1DP4860, 613
EP1DP	Dual height post
48	Height one
60	Height two
613	Silver

Specification Information
Specify trim color.

Application Notes
Dual height posts are used where panels of two different heights intersect.
NOTE: EP1 & EP2 Panels and components are available in legacy colors only.
Bottom levelers on posts allow for up to 1½" vertical adjustment.
Due to the variety of combinations possible, connector caps, shrouds and post covers must all be ordered separately.

Generation 1

triple height posts



Triple Height Post

W	D	H	PATTERN NO	P1	P2	P3
-	-	28"/40"/48"	EP1TP284048	\$193	N/A	\$215
-	-	28"/40"/53"	EP1TP284053	193	N/A	215
-	-	28"/40"/60"	EP1TP284060	193	N/A	215
-	-	28"/40"/65"	EP1TP284065	206	N/A	229
-	-	28"/40"/80"	EP1TP284080	230	N/A	253
-	-	28"/48"/53"	EP1TP284853	193	N/A	215
-	-	28"/48"/60"	EP1TP284860	193	N/A	215
-	-	28"/48"/65"	EP1TP284865	206	N/A	229
-	-	28"/48"/80"	EP1TP284880	230	N/A	253
-	-	28"/53"/60"	EP1TP285360	193	N/A	215
-	-	28"/53"/65"	EP1TP285365	205	N/A	227
-	-	28"/53"/80"	EP1TP285380	229	N/A	249
-	-	28"/60"/65"	EP1TP286065	206	N/A	229
-	-	28"/60"/80"	EP1TP286080	230	N/A	253
-	-	28"/65"/80"	EP1TP286580	230	N/A	253
-	-	40"/48"/53"	EP1TP404853	193	N/A	215
-	-	40"/48"/60"	EP1TP404860	193	N/A	215
-	-	40"/48"/65"	EP1TP404865	206	N/A	229
-	-	40"/48"/80"	EP1TP404880	230	N/A	253
-	-	40"/53"/60"	EP1TP405360	193	N/A	215
-	-	40"/53"/65"	EP1TP405365	205	N/A	227
-	-	40"/53"/80"	EP1TP405380	229	N/A	249
-	-	40"/60"/65"	EP1TP406065	206	N/A	229
-	-	40"/60"/80"	EP1TP406080	230	N/A	253
-	-	40"/65"/80"	EP1TP406580	230	N/A	253
-	-	48"/53"/60"	EP1TP485360	193	N/A	215
-	-	48"/53"/65"	EP1TP485365	205	N/A	227
-	-	48"/53"/80"	EP1TP485380	208	N/A	231
-	-	48"/60"/65"	EP1TP486065	206	N/A	229
-	-	48"/60"/80"	EP1TP486080	230	N/A	253
-	-	48"/65"/80"	EP1TP486580	230	N/A	253
-	-	53"/60"/65"	EP1TP536065	205	N/A	227
-	-	53"/60"/80"	EP1TP536080	207	N/A	230
-	-	53"/65"/80"	EP1TP536580	230	N/A	253
-	-	60"/65"/80"	EP1TP606580	230	N/A	253

Order Code	Specification Information	Application Notes
e.g. EP1TP406080, 113	Specify trim color.	Triple height posts are used where 3 or 4 panels of three different heights intersect.
EP1TP Triple height post		Bottom levelers on posts allow for up to 1½" vertical adjustment.
40 Height one		Due to the variety of combinations possible, connector caps, shrouds and post covers must all be ordered separately.
60 Height two		
80 Height three		
113 Dark Grey trim		

NOTE: EP1 & EP2 Panels and components are available in legacy colors only.

Single Height Post



W	D	H	PATTERN NO	P1	P2	P3
-	-	28"	EP1P28	\$72	N/A	\$78
-	-	40"	EP1P40	73	N/A	80
-	-	48"	EP1P48	74	N/A	83
-	-	53"	EP1P53	76	N/A	84
-	-	60"	EP1P60	77	N/A	86
-	-	65"	EP1P65	78	N/A	87
-	-	80"	EP1P80	83	N/A	89

Order Code

e.g. EP1P48, 177

EP1P Post

48 Height

117 Soft Grey trim

Specification Information

Specify trim color.

Panel connectors and shrouds must be order separately.

Application Notes

Bottom leveler on posts allow for up to 1½" of vertical adjustment.

NOTE: EP1 & EP2 Panels and components are available in legacy colors only.

Generation 1

Panel connectors and shrouds

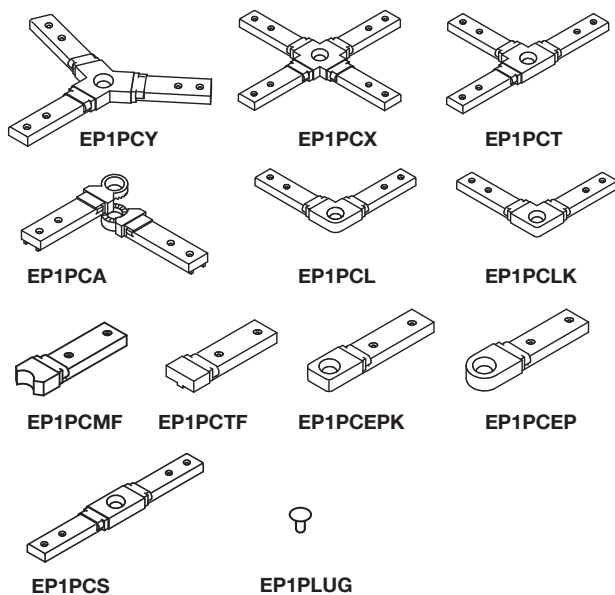

Panel Connectors

TYPE	PATTERN NO	P1	P2	P3
End with post	EP1PCEP	\$36	\$38	\$39
End with post (for post covers)	EP1PCEPK	36	38	39
Four-way "X"	EP1PCX	52	56	62
Multi-height filler	EP1PCMF	26	28	29
Post plug (pkg. of 25)	EP1PLUG	17	23	24
Straight	EP1PCS	31	33	35
Three-way "T"	EP1PCT	47	49	52
Three-way "Y" 120°	EP1PCY	47	49	52
Trim filler	EP1PCTF	26	28	29
Two-way "L"	EP1PCL	39	40	41
Two-way "L" (for post covers)	EP1PCLK	39	40	41
Two-way adjustable angle	EP1PCA	49	56	56

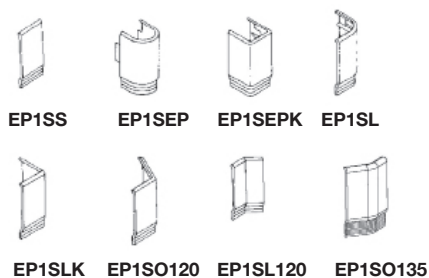

Raceway Shrouds

End with post	EP1SEP	49	N/A	56
End with post (for post covers)	EP1SEPK	49	N/A	56
Inside 120	EP1SI120	17	N/A	24
Outside "L"	EP1SL	36	N/A	39
Outside "L" (for post covers)	EP1SLK	36	N/A	39
Outside 120	EP1SO120	28	N/A	31
Outside 135	EP1SO135	28	N/A	31
Straight	EP1SS	26	N/A	29

Order Code	
e.g.	EP1SEP
EP1S	Post shroud
EP	End with post

Specification Information	
Specify panel connector and shroud trim color.	NOTE: EP1 & EP2 Panels and components are available in legacy colors only.
Specify one multi-height filler (EP1PCMF) for each low panel in a multi-height connection.	EXCEPTION: EP1 posts connectors only are available in all colors as they may need to be specified when ordering stack-on panels with an EP3 profile.

Application Notes	
Panel connectors stabilize panel to panel connections.	be purchased separately.
Panel connectors have painted finish and a quick mount design.	The EP1PCTF is a trim filler piece that is to be used when no other post part can be used in a given panel layout.
Mounting screws are included. Conical connector screw is included with post.	This piece butts against EP1PCS and EP1PCT, when installed as an addition.
One Post Plug (OPPC) is included with every connector cap ordered. If additional post plugs are required a bag of 25 may	Shrouds provide a finished raceway cover at posts. Two-way "L" connections do not require an inside shroud.

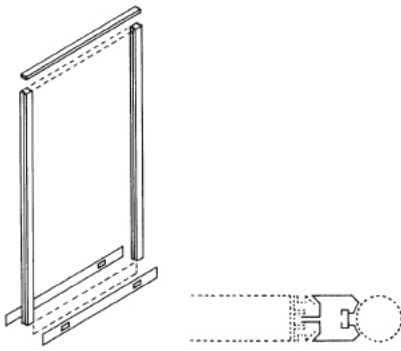

Panel Extender Kit – 36" Wide

W	D	H	PATTERN NO	P1	P2	ADD FOR P3
36"	–	40"	EP1PE3640R	\$352	N/A	\$50
36"	–	48"	EP1PE3648R	392	N/A	50
36"	–	53"	EP1PE3653R	423	N/A	50
36"	–	60"	EP1PE3660R	451	N/A	50
36"	–	65"	EP1PE3665R	477	N/A	50
36"	–	80"	EP1PE3680R	553	N/A	50

Panel Extender Kit – 40" Wide

48"	–	40"	EP1PE4840R	366	N/A	50
48"	–	48"	EP1PE4848R	408	N/A	50
48"	–	53"	EP1PE4853R	435	N/A	50
48"	–	60"	EP1PE4860R	469	N/A	50
48"	–	65"	EP1PE4865R	489	N/A	50
48"	–	80"	EP1PE4880R	569	N/A	50

Panel Extender Kit – 60" Wide

60"	–	40"	EP1PE6040R	387	N/A	50
60"	–	48"	EP1PE6048R	423	N/A	50
60"	–	53"	EP1PE6053R	452	N/A	50
60"	–	60"	EP1PE6060R	485	N/A	50
60"	–	65"	EP1PE6065R	507	N/A	50
60"	–	80"	EP1PE6080R	582	N/A	50

Order Code	
e.g.	EP1PE6065R, 117
EP1PE	Raceway panel extender kit
60	Width in inches
65	Height
R	Raceway
117	Soft Grey trim

Specification Information	
Specify trim color.	
Jumpers to carry power through panel are ordered separately. With panel extender kits, add 3" to jumper length for each panel extender kit used.	

A kit designed to be field mounted onto panels to extend the width of the panel by 3" (1½" on each side). This adaption of the panel(s) will allow clearance when positioning existing freestanding equipment, i.e., files and desks, between side panels.

Application Notes
Kit contains two aluminum side extrusions, an extended top cap, extended baseboard covers, an extended communication boot, installation hardware and instructions.
NOTE: EP1 & EP2 Panels and components are available in legacy colors only.

"E" Series electrical

Dedicated Neutral System components



Terminal Block

NOMINAL LENGTH	PATTERN NO	LIST
	EE1TB-(N3/N4)	\$72.



Duplex Receptacle (10 pack)

	EE1RIIN P10	437
	EE1RIIN P10	437
	EE1RIN P10	437
	EE1RIVN P10	437



Duplex Receptacle

	EE1RIIN	58
	EE1RIIN	58
	EE1RIN	58
	EE1RIVN	58

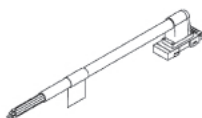

Base Infeed

54"	EE1BI-(N3/N4)	312
72"	EE1BI72-(N3/N4)	330

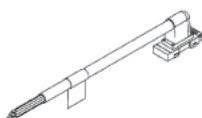

San Francisco Base Infeed

54"	EE1BI-(N3/N4)SF	312
72"	EE1BI72-(N3/N4)SF	330

Order Code	
e.g.	EE1C30-N3
EE1C	Conduit jumper
80	Length
N3	8-wire dedicated neutral

Specification Information	
8-wire N3 = 2+1 system (2 hots and 2 neutrals sharing one ground, 1 isolated hot and 1 isolated neutral on an isolated ground)	
10-wire N4 = 2+2 system (2 hots and 2 neutrals sharing one ground, 2 hots and 2 neutrals sharing another ground)	

Application Notes	
Jumpers: Transmit power circuits from one panel mounted terminal block to another. Can carry power through panels where no terminal blocks are installed. The length of the jumper corresponds to the distance between the terminal blocks.	
To calculate the correct length	
1. Add widths of both panels containing terminal blocks.	
2. Divide by two.	
3. Add width of any non-electrified panels in-between.	
The result is the correct jumper length.	
Example	
	$36" + 24" = 60"$ $60" \div 2 = 30"$ $30" + 48" = 78"$ Order EE1C78-N3

Jumper

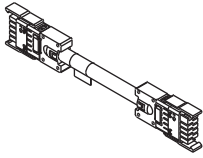

NOMINAL LENGTH	PATTERN NO	LIST
18"	EE1C18-(N3/N4)	\$133
21"	EE1C21-(N3/N4)	141
24"	EE1C24-(N3/N4)	145
27"	EE1C27-(N3/N4)	152
30"	EE1C30-(N3/N4)	157
33"	EE1C33-(N3/N4)	161
36"	EE1C36-(N3/N4)	162
39"	EE1C39-(N3/N4)	167
42"	EE1C42-(N3/N4)	174
45"	EE1C45-(N3/N4)	178
48"	EE1C48-(N3/N4)	179
51"	EE1C51-(N3/N4)	187
54"	EE1C54-(N3/N4)	187
57"	EE1C57-(N3/N4)	193
60"	EE1C60-(N3/N4)	202
63"	EE1C63-(N3/N4)	206
66"	EE1C66-(N3/N4)	208
69"	EE1C69-(N3/N4)	208
72"	EE1C72-(N3/N4)	219
75"	EE1C75-(N3/N4)	223
78"	EE1C78-(N3/N4)	227
81"	EE1C81-(N3/N4)	230
84"	EE1C84-(N3/N4)	232
87"	EE1C87-(N3/N4)	241
90"	EE1C90-(N3/N4)	244
93"	EE1C93-(N3/N4)	247
96"	EE1C96-(N3/N4)	253
99"	EE1C99-(N3/N4)	255
102"	EE1C102-(N3/N4)	259
105"	EE1C105-(N3/N4)	266
108"	EE1C108-(N3/N4)	267
111"	EE1C111-(N3/N4)	277
114"	EE1C114-(N3/N4)	280
120"	EE1C120-(N3/N4)	293
126"	EE1C126-(N3/N4)	298
132"	EE1C132-(N3/N4)	305
144"	EE1C144-(N3/N4)	322

Order Code	
e.g.	EE1C30-N3
EE1C	Conduit jumper
80	Length
N3	8-wire dedicated neutral

Specification Information	
8-wire N3 = 2+1 system (2 hots and 2 neutrals sharing one ground, 1 isolated hot and 1 isolated neutral on an isolated ground)	
10-wire N4 = 2+2 system (2 hots and 2 neutrals sharing one ground, 2 hots and 2 neutrals sharing another ground)	

Application Notes	
<p>Jumpers: Transmit power circuits from one panel mounted terminal block to another. Can carry power through panels where no terminal blocks are installed. The length of the jumper corresponds to the distance between the terminal blocks.</p>	<p>To calculate the correct length</p> <ol style="list-style-type: none"> 1. Add widths of both panels containing terminal blocks. 2. Divide by two. 3. Add width of any non-electrified panels in-between. <p>The result is the correct jumper length.</p>
<p>Example</p> <p>36" + 24" = 60" 60" ÷ 2 = 30" 30" + 48" = 78" Order EE1C78-N3</p>	

Panel accessories

Cable and Wire Managers



Vertical Wire Manager

W	D	H	PATTERN NO	P1	P2	P3
1/2"	3/4"	80"	EC1VWM80	\$29	\$31	\$33



Metal Ceiling Module

4"	1 1/2"	120"	EE1CM40M	\$625	N/A	\$689
4"	1 1/2"	120"	EE1CM48M	625	N/A	689
4"	1 1/2"	120"	EE1CM53M	625	N/A	689
4"	1 1/2"	120"	EE1CM60M	625	N/A	689
4"	1 1/2"	120"	EE1CM65M	625	N/A	689
4"	1 1/2"	120"	EE1CM80M	625	N/A	689

Order Code	
e.g.	EC1VWM80, 177
EC1VWM	Vertical Wire Manager
80	Length
117	Soft Grey trim

Specification Information
Specify trim color.

Vertical Wire Manager:
A plastic strip designed to hide a cord running down the edge of the panel. Cut to desired length in field.

Ceiling Infeed Modules:
Electrical harnesses not included with modules. Modules are hollow to accommodate power and/or data cables from source into systems furniture.

With electrical harness installed, infeed holds 35 cables.
Cables/conduit are laid into the lower metal body by removal of the front 1-1/2" wide access cover and into the upper plastic extrusion by separating the front edge of the pliable tube. Infeed module is attached to an available post location of the appropriate height. The

module can not be used for panel support and there are no "hang on" capabilities. Includes escutcheon plate. Plate and plastic tube are white to integrate with standard ceiling color. No "hang on" capabilities. Module cannot be used for panel support.

Painted metal module is 120" long metal extrusion with attachment hooks at proper height to attach to appropriate height post. Infeed holds 35 cables with electrical harness installed.

Cables/conduit are laid into module by removal of two-piece front 1-1/2" wide vertical access cover which runs the length of the extrusion. Includes escutcheon plate which is white to integrate with ceiling. Tube is trim colored to match system trim.
To connect a metal ceiling infeed to a corner or a straight connection you must use an adjustable angle connector or adjustable angle connector with a multi-height panel connector.



EP1 Coat Hook (6/carton)

W	D	H	PATTERN NO	P1	P2	P3
1/2"	3/4"	5"	EP1CH	\$120	N/A	N/A



Coat Hanger

W	D	H	PATTERN NO	P1	P2	P3
17"	3/8"	9 1/4"	EP1CHG	15	N/A	N/A



Carpet Gripper (12 pack)

W	D	H	PATTERN NO	P1	P2	P3
			EP1CG12	38	N/A	N/A



EP3 Coat Hook Straight (5 pack)

W	D	H	PATTERN NO	P1	P2	P3
1/8"	1 3/8"	2 3/8"	EP3MMCH (B/P)	141	N/A	N/A



EP3 Coat Hook Postless End (5 pack)

W	D	H	PATTERN NO	P1	P2	P3
1 3/8"	3/8"	2 3/8"	EP3MMCHPE (R/L)(B/P)	141	N/A	N/A

Order Code	
e.g.	EP1CH, 117
EP1CH	Coat hook
117	Soft Grey trim

Specification Information

Specify trim color.

Coat Hook and Coat Hanger available only in Dark Neutral, Medium Grey, Soft Grey or Taupe.

NOTE: EP1 & EP2 Panels and components are available in legacy colors only.

Application Notes

Coat Hanger
A plastic coat hanger available to hang on coat hook. EP1 Coat hook: Molded plastic hook hangs over EP1 panels to hold coats and hangers. Coat hook must hang over straight post location if being used w/EP3 panels. Carpet gripper: 12 per package. EP3 Coat hook: Aluminum coat hook attaches to any exposed Equity vertical slot. There are two versions. The straight version will work on any Equity vertical slot except for those on an inside corner. The postless end version is handed and extends beyond the edge of a panel with a postless end. Hand is determined by which side of the panel the coat hook is installed on while facing the panel. Available in two colors; Black (B) or Matte Aluminum (P).

Counter Caps, Straight

Generation 1 and Generation 2 profiles

Straight

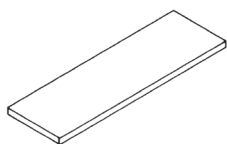

NOMINAL W	ACTUAL W	D	H	PATTERN NO	P1	P2	P3
12"	10.5"	15.25"	–	EW(1/2)1215	\$268	\$278	\$284
24"	22.5"	15.25"	–	EW(1/2)2415	297	303	311
30"	28.5"	15.25"	–	EW(1/2)3015	323	332	339
36"	34.5"	15.25"	–	EW(1/2)3615	323	332	339
42"	40.5"	15.25"	–	EW(1/2)4215	330	336	344
48"	46.5"	15.25"	–	EW(1/2)4815	333	341	348
60"	58.5"	15.25"	–	EW(1/2)6015	367	374	382
72"	70.5"	15.25"	–	EW(1/2)7215	387	392	402
84"	82.5"	15.25"	–	EW(1/2)8415	419	427	435
96"	94.5"	15.25"	–	EW(1/2)9615	435	444	451
108"	106.5"	15.25"	–	EW(1/2)10815	449	456	464
120"	118.5"	15.25"	–	EW(1/2)12015	500	506	513

Straight – Extended One End

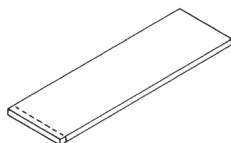

12"	12"	15.25"	–	EW(1/2)1215E	279	286	296
24"	24"	15.25"	–	EW(1/2)2415E	305	314	322
30"	30"	15.25"	–	EW(1/2)3015E	329	334	342
36"	36"	15.25"	–	EW(1/2)3615E	329	334	342
42"	42"	15.25"	–	EW(1/2)4215E	336	344	351
48"	48"	15.25"	–	EW(1/2)4815E	347	353	361
60"	60"	15.25"	–	EW(1/2)6015E	373	380	388
72"	72"	15.25"	–	EW(1/2)7215E	405	410	418
84"	84"	15.25"	–	EW(1/2)8415E	422	430	438
96"	96"	15.25"	–	EW(1/2)9615E	441	448	455
108"	108"	15.25"	–	EW(1/2)10815E	473	481	489

Straight – Extended Both Ends

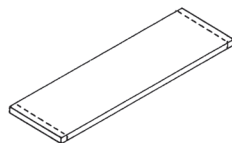

12"	13.5"	15.25"	–	EW(1/2)1215EE	286	296	302
24"	25.5"	15.25"	–	EW(1/2)2415EE	319	325	333
30"	31.5"	15.25"	–	EW(1/2)3015EE	334	342	350
36"	37.5"	15.25"	–	EW(1/2)3615EE	334	342	350
42"	43.5"	15.25"	–	EW(1/2)4215EE	347	353	361
48"	49.5"	15.25"	–	EW(1/2)4815EE	387	392	402
60"	61.5"	15.25"	–	EW(1/2)6015EE	383	390	397
72"	73.5"	15.25"	–	EW(1/2)7215EE	413	420	428
84"	85.5"	15.25"	–	EW(1/2)8415EE	436	445	452
96"	97.5"	15.25"	–	EW(1/2)9615EE	449	456	464
108"	109.5"	15.25"	–	EW(1/2)10815EE	487	494	502

Order Code	
e.g.	EW16015,117, 117
EW1	Worksurface
60	Width
15	Depth
117	Soft Grey laminate
117	Soft Grey edge
117	Soft Grey cantilever trim

Specification Information			
Specify surface, trim and cantilever trim color.	Counter caps are designed for mounting on top of panels.	A counter cap extension (E) covers one post.	When specifying a top with a metal edge band add \$52 to the standard list price.
EW1 Counter caps work with all existing counter caps and are for use on Generation 1 or Generation 2 panels only. Plastic cantilevers are supplied.	Straight counter caps overhang both sides of the panel equally.	A counter cap extension (EE) covers 2 posts.	NOTE: Add 10% to the list price of any counter cap when specifying a legacy laminate.
EW2 counter caps are for use with Generation 3 panels only. Steel brackets are provided.	Counter caps fit between posts, appropriate to fit between two taller panels and a duel/triple height connectors.	Steel mounted brackets are supplied.	
		Wood Grain and Metal edge bands: When specifying a top with a wood grain edge band add \$26 to the standard list price.	



Corner

W	D	H	PATTERN NO	P1	P2	P3
24"	15.25"	-	EW(1/2)CC2415	\$378	\$392	\$409
30"	15.25"	-	EW(1/2)CC3015	406	419	435
36"	15.25"	-	EW(1/2)CC3615	413	428	445

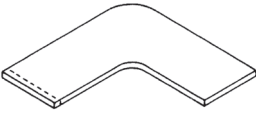

Corner – Extended Left

24"	15.25"	-	EW(1/2)CC2415LHE	387	402	416
30"	15.25"	-	EW(1/2)CC3015LHE	413	428	445
36"	15.25"	-	EW(1/2)CC3615LHE	422	438	453



Corner – Extended Right

24"	15.25"	-	EW(1/2)CC2415RHE	387	402	416
30"	15.25"	-	EW(1/2)CC3015RHE	413	428	445
36"	15.25"	-	EW(1/2)CC3615RHE	422	438	453

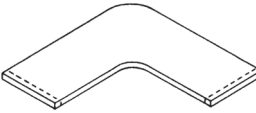

Corner – Extended Both Ends

24"	15.25"	-	EW(1/2)CC2415EE	402	416	432
30"	15.25"	-	EW(1/2)CC3015EE	436	452	466
36"	15.25"	-	EW(1/2)CC3615EE	445	461	474

Order Code	Specification Information	Application Notes
e.g. EW1CC3015, 117, 117	Specify surface, trim and cantilever trim color.	Counter caps are designed for mounting on top of panels.
EW1	Worksurface	Steel mounting brackets are supplied.
CC	Curved corner	A counter cap extension (E) covers one post.
30	Width	A counter cap extension (EE) covers 2 posts.
15	Depth	Wood Grain and Metal edge bands: When specifying a top with a wood grain edge band add \$26 to the standard list price.
117	Soft Grey laminate	When specifying a top with a metal edge band add \$52 to the standard list price.
117	Soft Grey edge	NOTE: Add 10% to the list price of any counter cap when specifying a legacy laminate.
117	Soft Grey cantilever trim	

Freestanding support components

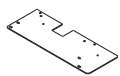

Flat Brackets (black only)

W	D	H	TOP SIZE	PATTERN NO.	P1	P2	P3
	15"			EB1F24	45.	n/a	n/a
	21"			EB1F30	52.	n/a	n/a



Column Base

		27¾"		EB1FCOL	320.	348.	362.
--	--	------	--	---------	------	------	------

Tackable Privacy Screens

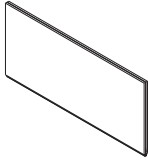

Tackable Privacy

W	D	H	PATTERN NO.	10	15	20	25	30	35	40	45
36"	¾"	21"	EF2PS36	392.	403.	426.	431.	443.	451.	458.	472.
42"	¾"	21"	EF2PS42	411.	426.	443.	452.	467.	473.	483.	495.
48"	¾"	21"	EF2PS48	428.	440.	461.	472.	485.	491.	499.	513.
60"	¾"	21"	EF2PS60	459.	475.	497.	507.	519.	529.	536.	553.
72"	¾"	21"	EF2PS72	491.	507.	531.	541.	556.	565.	574.	592.

Freestanding

Order Code

e.g.	EF2OS60, 117
EF2OS	Equity freestanding privacy screen
60	Length in inches
117	Soft Grey trim

Specification Information

Specify shelf and stanchion trim color where required.

NOTE: Fabric on 72" privacy screens and will be railroaded (turned 90°).

Application Notes

Over-desk storage units build on desk assemblies to form freestanding workstations.

Mounted on freestanding desks, the overall height of an over-desk will line up with a 65" high panel.

Stanchion loads must be carried to the floor by end panel or pedestal directly beneath it.

All freestanding product shipped knocked down (KD). Orchestra load bars will mount on stanchions with or without tack boards.

Task lights for overhead cabinet or shelf less than 60" wide need to be ordered at least 12" less than the width of the cabinet or shelf.

NOTE: Add 10% to the list price when specifying a legacy laminate.

WALL MOUNTING SUGGESTIONS

The following information is provided only as a guide, and represents minimum recommendations only. Neutral Posture does not accept responsibility for the attachment of any Neutral Posture product to a Customer's site wall. Wall specification/construction is the responsibility of the Customer and its structural engineer/architect. Failure to properly attach Neutral Posture products to adequate wall structures can lead to property damage and/or personal injury.

You should consult your own structural engineers and/or architects and must not rely on the information provided herein.

It is the responsibility of the Customer and its structural engineers/architects to verify that the permanent structural walls (studs, blocks, solid masonry, etc.) on which the

Neutral Posture products are intended to be mounted are designed appropriately to support the product weight, PLUS 3 lbs. per linear inch for each usable shelf length

NOTE: A cabinet's top is considered a "usable shelf" and MUST be included in the calculation of the total load for an overhead cabinet.

It is the responsibility of the Customer and its structural engineer/architects to specify the fasteners and method for attaching the Neutral Posture supplied wall mounting cleat, bracket, frame, etc. to the supporting wall and to confirm that the installers have adhered to these specifications. For all local building standards and codes, and additional requirements (including, but not limited to, seismic conditions) the Customer should always consult local code agencies.

New Construction

Existing Construction

	Cinder Block or Poured Concrete Masonry Wall	Wood Stud Wall, the studs being FULL HEIGHT to the roof/floor above	Wood Stud Wall, the studs being only Ceiling Height	Steel Stud Wall, the studs being FULL HEIGHT to the roof/floor above	Steel Stud Wall, the studs being only Ceiling Height	
Stud Specification	Wood studs, grade #2 or better, 3 1/2" minimum width, OR Metal studs, minimum 25 gage thickness, 3 3/8" minimum width	The wall must be a minimum of 6" thick, and must be full height to the roof/floor structure above	Wood studs must be Grade #2, or better, 3 1/2" minimum width	Wood studs must be Grade #2, or better, 3 1/2" minimum width	Metal studs must be minimum 25 gage thickness, 3 3/8" minimum width	
Stud Centers	Metal and wood studs must be spaced at 16" c/c maximum.	N/A	Wood studs must be spaced at 16" c/c maximum.	Wood studs must be spaced at 16" c/c maximum.	Metal studs must be spaced at 16" c/c maximum.	
Stud Height	Metal and wood studs must extend upwards, and be securely attached to the roof/floor structure above.			Wood studs must be braced above the ceiling, and be securely attached to the roof/floor structure above. Affix #2 grade 'cap' across the top of the studs, then place diagonal studs from the top cap up to underside of the roof/floor structure above.	Metal studs must be braced above the ceiling and be securely attached to the roof/floor structure above. Affix metal bracing 'cap' across the top of the studs. Then place diagonal studs from the top cap up to underside of the roof/floor structure above.	
Mounting the Neutral Posture Supplied Cleat, Bracket, Frame, etc	<p>Insert a 2" x 6" wood block, #2 grade or better, [or a locally approved flexible wood backing system] horizontally between each of the studs to accommodate the full width of the cabinet and beyond to the next stud.</p> <p>Fasten the wood block to each stud using three screws at the ends of each block.</p> <p>(Fasten the locally approved wood backing system as directed by the manufacturer.)</p> <p>Fasten the Neutral Posture supplied wall mounting cleat, bracket, frame, etc directly to each wood block every 6".</p> <p>For wall mounting structures that have a rectangular frame-like configuration: fasten the top horizontal element of the frame to the wood blocking every 6" and fasten the lower horizontal element to each wall stud, using one fastener per stud.</p>	<p>Fasten the Neutral Posture supplied cabinet wall mounting cleat, bracket, frame, etc. directly to the masonry wall every 6".</p> <p>For wall mounting structures that have a rectangular frame-like configuration: fasten the top horizontal element of the frame to the wall every 6" and fasten the lower horizontal element to the wall every 6".</p>	<p>In the desired location of the cabinet mounting rail, remove an 8" high section of drywall the width of the cabinet and beyond to the next stud.</p> <p>Insert a 2" x 6" wood block, #2 grade or better, horizontally between each of the exposed studs.</p> <p>Fasten the wood block to each stud using three screws at the ends of each block.</p> <p>Replace the drywall and repair as desired.</p> <p>Fasten the Neutral Posture supplied wall mounting cleat, rail, frame, etc directly to the wood block every 6".</p> <p>For wall mounting structures that have a rectangular frame-like configuration: fasten the top horizontal element of the frame to the wood blocking every 6", and fasten the lower horizontal element to each wall stud, using one fastener per stud.</p>	<p>In the desired location of the cabinet mounting rail, remove an 8" high section of drywall the width of the cabinet, and beyond to the next stud.</p> <p>Insert a 2" x 6" wood block, #2 grade or better, horizontally between each of the exposed studs.</p> <p>Fasten the wood block to each stud using three screws at the ends of each block.</p> <p>Replace the drywall and repair as desired.</p> <p>Fasten the Neutral Posture supplied wall mounting cleat, rail, frame, etc directly to the wood block every 6".</p> <p>For wall mounting structures that have a rectangular frame-like configuration: fasten the top horizontal element of the frame to the wood blocking every 6", and fasten the lower horizontal element to each wall stud, using one fastener per stud.</p>	<p>In the desired location of the cabinet mounting rail, remove an 8" high section of drywall the width of the cabinet and beyond to the next stud.</p> <p>Insert a 2" x 6" wood block, #2 grade or better, [or a locally approved flexible wood backing system] horizontally between each of the exposed studs.</p> <p>Fasten the wood block to each stud using three screws at the ends of each block.</p> <p>Replace the drywall and repair as desired.</p> <p>Fasten the Neutral Posture supplied wall mounting cleat, rail, frame, etc directly to the wood block every 6".</p> <p>For wall mounting structures that have a rectangular frame-like configuration: fasten the top horizontal element of the frame to the wood blocking every 6", and fasten the lower horizontal element to each wall stud, using one fastener per stud.</p>	<p>In the desired location of the cabinet mounting rail, remove an 8" high section of drywall the width of the cabinet and beyond to the next stud.</p> <p>Insert a 2" x 6" wood block, #2 grade or better, [or a locally approved flexible wood backing system] horizontally between each of the exposed studs.</p> <p>Fasten the wood block to each stud using three screws at the ends of each block.</p> <p>Replace the drywall and repair as desired.</p> <p>Fasten the Neutral Posture supplied wall mounting cleat, rail, frame, etc directly to the wood block every 6".</p> <p>For wall mounting structures that have a rectangular frame-like configuration: fasten the top horizontal element of the frame to the wood blocking every 6" and fasten the lower horizontal element to each wall stud, using one fastener per stud.</p>
Fasten the Neutral Posture supplied wall cleat with...	#10 x 2 1/2" wood screws or equiv. in every mounting hole provided, screwed directly into the wood blocking	3/16" x 3 1/2" masonry screws or equiv. in every mounting hole provided with 1 1/4" embedment, screwed directly into the masonry wall	#10 x 2 1/2" wood screws or equiv. in every mounting hole provided, screwed directly into the wood blocking	#10 x 2 1/2" wood screws or equiv. in every mounting hole provided, screwed directly into the wood blocking	#10 x 2 1/2" wood screws or equiv. in every mounting hole provided, screwed directly into the wood blocking	

Selling Policy

TERMS AND CONDITIONS

For all non-rated or new accounts, payment terms are Cash in Advance (C.I.A.) until credit has been approved or rated. Please send full credit information and references and allow time for Credit Department approval.

For all established accounts, payment is due within thirty (30) days from the invoice date. Neutral Posture (NP) reserves the right to change or cancel the terms of sale based on volume, credit rating and/or credit information. Prepayment, whole or in part, may be requested at any time at the discretion of the corporate office. For orders greater than \$100,000 net, a fifty percent (50%) deposit is due at the time of order placement, with the remainder due within thirty (30) days of the date of invoice.

Past due accounts are subject to a 1.5% late charge or maximum amount permitted under local law, for each thirty (30) days the outstanding balance remains open after the due date.

Withholding of payments based on carrier damages, shortages or other disputes is illegal and subject to charges.

Neutral Posture does not accept credit cards.

ORDERING

All orders must be in writing; faxed, e-mailed or mailed. The product pattern number(s) contained in the order acknowledgment shall be the final expression of the order. A purchase order is not binding on NP until customer has received NP's order confirmation or acknowledgment. Orders must have a contact name and phone number. Orders may not be canceled without written consent of Neutral Posture.

To expedite complete/correct entry of your order, be certain all pattern numbers, quantities, colors and area identifications are completely specified. Also, include complete purchase order number(s), bill-to and ship-to addresses, a contact name and specific factory shipping dates required.

Orders should be sent to:
Neutral Posture, Inc
3904 N Texas Avenue Bryan, TX 77803
979.778.0502 (Option 2)
800.446.3746
979.778.0408 FAX
E-mail: oe@neutralposture.com

When an order is received, it is assigned a scheduled ship date. That date is shown on the customer's acknowledgment.

Purchase orders may not be changed or canceled, in whole or in part, without prior written consent of NP. Changes may affect delivery dates. Expenses incurred because of changes shall be charged to customer. In the event of cancellations, customer will be liable for reasonable cancellation charges established by NP. Orders for special product, orders including customer's own material (COM) and orders pursuant to expedited delivery programs, may not be canceled.

A minimum of 3% of net expedite fee will be charged for orders requiring less than standard lead times.

PRICES

Prices are subject to change without notice. List prices shall be those in effect on the date of receipt of purchase order unless shipment is requested more than ninety (90) days after order entry in which case prices in effect on the date of shipment apply. Prices in effect at time of shipment prevails in the event of a discrepancy.

TAXES

All sales, use, excise and other taxes applicable to the sale of the products shall be paid by customer. If customer claims an exemption from any tax, customer shall submit to NP the appropriate exemption certificates.

LEAD TIME

Please contact Sales Support for current lead time at customerservice@neutralposture.com or 979.778.0502.

STORAGE FEE

Any changes made by the customer to postpone the delivery date on orders which have already gone into production, will be charged a storage fee. This fee will be applied to both partially and fully built orders. NP will advise of fee prior to applying charge.

SHIPPING

Most NP products include free shipping. All standard discount orders are F.O.B destination delivered by parcel or prepaid freight to commercial shipping points located within the forty-eight (48) contiguous United States, District of Columbia and within Canada, excluding the Yukon, Northwest Territories, Nunavut and Newfoundland. NP will designate the shipping mode and carrier based on geographical location and best service defined by our Logistics Department.

For orders shipping outside the forty-eight (48) contiguous United States, District of Columbia and within Canada, excluding the Yukon, Northwest Territories, Nunavut and Newfoundland, customer pays shipping from port of embarkation to destination and order will be shipped "best way". Customer will incur additional charges if they choose to specify a freight carrier.

Even though free shipping does apply to most domestic orders, in some cases accessorial charges may apply for specialized freight services beyond normal pick up, transport, and delivery such as limited access, high security, re-consignment and unusual wait times. Consignee will be responsible for paying accessorial charges relating to their orders. The following list includes, but is not limited to, accessorial charges that will apply to domestic orders. Please contact Sales Support at customerservice@neutralposture.com for a quote.

Accessorial Charges (Net)

Inside Delivery/Pick Up
Lift Gate Required
Limited Access Delivery
Notification/CBD
Residential Delivery
Ship Fully Assembled
Pre-delivery Notification
Re-delivery/Return Trip

TERMS AND CONDITIONS

FREIGHT DAMAGE

Upon receipt of shipment, check delivery for shortages or signs of damage. If a problem is discovered, bring it to the driver's attention immediately. If any of the goods called for on the Bill of Lading are shorted or damaged, consignees should not accept them until the carrier makes a notation on the freight bill of the shorted or damaged goods. The more precise your notation, the easier the claim can be resolved. NP's responsibility ceases when the consignee signs the freight delivery receipt as received in good condition. Shipping claims must be made within thirty (30) days of shipment delivery.

RETURNS

The return of product without written authorization by NP shall not be accepted. All merchandise returns must be pre-approved by the corporate office and sent freight prepaid. Contact the Warranty Department, warrantyrequest@neutralposture.com, to receive a Return Merchandise Authorization (RMA) number for any return. RMAs are valid for thirty (30) days and any returned merchandise without a RMA number will be refused.

No deductions from any NP invoices can be made for return merchandise until it is approved by the corporate office. No deductions will be honored until returned goods are processed through our Quality Control Audit.

All returns for canceled orders must be pre-approved by the corporate office and sent freight prepaid. No returns will be authorized unless our inventory allows it, the parts are in good reusable condition and it was sold within the last thirty (30) days. Authorized seating returns will be charged a thirty percent (30%) (twenty percent (20%) for GSA) restocking fee, by agreement, to cover handling, inspection, stocking and repackaging. Authorized systems returns are subject to a forty-five percent (45%) of list restocking charge. Products not currently offered for sale by NP (including COM) shall not be authorized for return. All returned products must be unused, in original condition and in the original NP packing cartons. No refund or credit will be given for damaged products.

WARRANTY CLAIMS

Neutral Posture reserves the right to specify that items or parts claimed to be defective, be returned to the factory for our inspection. If the claim is justified, repair or replacement of defective parts under warranty will be made through NP at no cost to the customer. NP will, at its discretion, reimburse the furniture dealer for labor (actual costs only) on warranty parts. The furniture dealer must submit a quote to be approved prior to service. If approved, the furniture dealer must then submit an invoice to NP for reimbursement after the service is completed. Freight for products and parts covered under warranty will be covered for the forty-eight (48) contiguous states, the District of Columbia and Canada, excluding the Yukon, Northwest Territories, Nunavut and Newfoundland, with the method of shipping at NP's discretion. All claims must include the product serial number. NP will have no warranty obligation if the product was subjected to abuse, alteration, misuse, negligence or accident or if the user fails to perform the proper maintenance for the product.

CUSTOMER'S OWN MATERIAL

A customer who requests a fabric or other surface material not standard to NP's line of products (COM), must submit samples of the requested material to NP prior to entry of a customer order. NP shall determine if the material is suitable to its manufacturing processes and meets any requirements of Underwriters Laboratories and/or Canadian Standards Association. If the COM is acceptable, NP will then establish a price for using the COM. For a description of the procedures for submitting samples and testing, contact Sales Support. NP shall have no responsibility for the appearance, condition, performance, durability, colorfastness or any other physical attribute of the COM. Customer shall indemnify and hold NP harmless for any damages, injuries or losses arising out of or related to use of the COM on the product.

DELAY/FORCE MAJEURE

Neutral Posture shall not be liable for failure to perform or for delay in performance due to fire, flood, strike or other labor difficulty, act of God, act of any governmental authority or of the customer, riot, embargo, fuel or energy shortage, wrecks or delay in transportation, inability to obtain necessary labor, materials or manufacturing facilities from usual sources or failure of suppliers to meet their contractual obligations, or due to any cause beyond its reasonable control. If any such event occurs, Neutral Posture may extend delivery dates by a period of time necessary to overcome the effect of such delay, allocate available product or cancel any purchase order.

COMPLIANCE WITH LAW

Customer is solely responsible for compliance with all applicable federal, state and local laws, ordinances, regulations, rules and standards relating to the installation, maintenance, use and operation of the products.

Selling Policy

WARRANTY

Neutral Posture warrants to the original purchaser only that the products Neutral Posture manufactures and sells to purchaser are free of defects in workmanship and materials, during the applicable warranty period set forth below.

This comprehensive warranty applies to all products installed or reconfigured by an authorized installer.

Warranty period set forth below is for 24-hour, 7 days a week, multi-shift use. Should any failure occur to a product listed below during the applicable warranty period from the date of shipment, Neutral Posture shall, upon prompt written notice, repair or replace, at its option, the affected part or parts.

PRODUCT AND PERIOD OF WARRANTY

Lifetime

Panels and panel connector parts, high pressure laminate worksurfaces, table tops and common tops, storage, modesty/privacy screens

10 Years

Cascade worksurfaces, height adjustable worksurface supports (except for gas lift), laminate overhead doors, desktop and storage accessories (unless otherwise specified)

5 Years

Table bases, tapered table legs, anti-fatigue mats, operational parts, controls, electrical, lighting (except light ballasts, bulbs and power supply), special or custom product, height adjustable worksurface support gas lift

3 Years

Electric height adjustable bases (including motor), fabric

1 Year

Light ballasts, bulbs and power supply

This warranty does not apply to:

- Damage caused by a carrier.
- Normal wear and tear or acts or omissions of parties other than Neutral Posture (including user modification, improper use or installation of products).
- COM or other third party materials applied to products.
- Products not installed by or under the auspices of a Neutral Posture Dealer.
- Dramatic temperature variations or exposure to unusual conditions.
- Changes in surface finishes including colorfastness due to aging or exposure to light.

The express warranties contained herein are in lieu of all other warranties, express or implied, including any warranties of merchantability and fitness for particular purpose and all other warranties arising from course of dealing or usage of trade.

The remedies provided above are the customer's sole remedies for any failure of Neutral Posture to comply with its obligations regarding the workmanship of its products. Correction of any nonconformity in the manner and for the period of time provided shall constitute complete fulfillment of all liabilities of Neutral Posture, with respect to or arising out of the product furnished hereunder.

GENERAL INFORMATION

CERTIFICATION

Independent tests show that Equity components meet or exceed current ANSI/BIFMA X5.6 Panel System and ANSI/BIFMA X5.9 Storage Unit standards. Electrical components are UL listed. Panels have tested to NRC ratings of 0.75.

SCS INDOOR ADVANTAGE CERTIFICATION

The Equity product line is certified by SCS Global Services for indoor air quality.

DESIGN

NP reserves the right to make changes and improvements in design and materials and to discontinue parts and components at the discretion of NP.

WOMEN'S BUSINESS ENTERPRISE (WBE)

This certification is administered by the Women's Business Enterprise National Council (WBENC) and is used by most large corporations to qualify potential vendors as credible diversity suppliers.

WOMAN OWNED SMALL BUSINESS (WOSB)

The U.S. Small Business Administration's WOSB Federal Contract Program provides greater access to federal contracting opportunities for WOSBs. The program allows contracting officers to set aside specific contracts for certified WOSBs and helps federal agencies achieve the existing statutory goal of five percent of federal contracting dollars being awarded to WOSBs. NP is certified as a WOSB.

HISTORICALLY UNDERUTILIZED BUSINESS (HUB)

The Texas Historically Underutilized Business (HUB) program encourages the use of HUBs in state procurement and provides information to minority and woman-owned businesses on the state's procurement process.

BUSINESS AND INSTITUTIONAL FURNITURE

MANUFACTURER'S ASSOCIATION

NP is a member of the Business and Institutional Furniture Manufacturer's Association (BIFMA). Tests developed by BIFMA and approved by the American National Standards Institute (ANSI) determine the strength and durability of office furniture in its everyday use. Although this testing does not serve as a warranty or guarantee, NP standard products within this price list meet or exceed applicable ANSI/BIFMA X5.6 Panel Systems and ANSI/BIFMA X5.9 Storage Unit standards. Combinations of options added on to the standard products may not meet ANSI/BIFMA standards. Those combinations which do not meet ANSI/BIFMA standards are not available on GSA. Additionally, Equity is BIFMA level 1 certified. For more information, contact Sales Support at customerservice@neutralposture.com.

Building an effective Green Program takes a company-wide effort, but we think it's worth the effort to ensure that our manufacturing process leaves the smallest footprint on the environment. Neutral Posture products are designed and manufactured to support a long and useful product life. Our products, if need be, can withstand repeated service, repairs and handling; and our products are made with standardized parts and components which make replacing worn out parts easy and as green as possible.

- BIFMA level® Certification
- LEED
- Buy Back Take Back Program
- Product Breakdown Instructions
- Recycling Neutral Posture Product by Region

GREEN MANUFACTURING PROCESS

Neutral Posture is highly efficient in its manufacturing process. Its products are manufactured with only 1% scrap by weight. The company has established a 100% solid waste diversion goal for its manufacturing process and is very close to reaching it. Current manufacturing processes do not use water or hazardous chemicals.

Plastic

Neutral Posture uses plastic which contains up to 25% pre-consumer recycled plastics. The majority of the plastics used in Neutral Posture products are #5 plastics and can be recycled in many areas.

Steel

Neutral Posture products contain steel that is 100% recyclable. Additionally, up to 25% of this steel comes from pre-consumer recycled product.

Fabric

Neutral Posture maintains an excellent supply of green fabrics. These fabrics are made from pre- and post-consumer recycled materials, soy and other rapidly renewable resources.

Panel Inner

Neutral Posture uses mineral wool, spun from rocks to provide sound resistance in its panels. These mineral wool inserts are considered rapidly renewable products.

GREEN SHIPPING INITIATIVES

Neutral Posture holds their freight carrier partners accountable to similar criteria as suppliers, however, due to the immense impact freight companies have on the environment, all carriers must also become a partner in the Environmental Protection Agency (EPA) SmartWay program within one year of service. All freight carriers are screened through a logistics company and become a partner associate with Neutral Posture based on monthly evaluation reports provided by the logistics company.

PACKAGING OPTIONS

Our cardboard shipping boxes are produced from 45% recycled material and 100% of the materials come from renewable pulp sources. For large orders, customers can opt to blanket wrap their chairs, which totally eliminates packing waste or could choose to use a box made from 100% recycled materials for an upcharge.

A LONG AND HEALTHY PRODUCT LIFE

Neutral Posture products are made to last, as is evidenced by our limited lifetime warranty. Neutral Posture has been around since the 1980s, and it is not unusual to find original products from our first year of production in perfect working condition. Although we are continually improving our products, we allow for retrofitting of earlier generations. This allows the customer to upgrade individual components as desired without having to discard the product they already have or purchase a new one. This helps avoid filling landfills with used chairs and is another way in which Neutral Posture customers contribute to their immediate health and wellbeing as well as the continued wellness of our environment.

For more information about Neutral Posture and sustainable design, visit neutralposture.com/sustainability

Key Lock Program

GENERAL INFORMATION

Following is the Neutral Posture key lock policy, applicable to all products.

Neutral Posture pedestals, overheads, and storage cabinets ship without lock cores installed. The locks are field installed. If your purchase order does not specify key-alike you will automatically receive random lock cores with your order.

Neutral Posture furniture can be keyed-alike or random keyed.

KEY-ALIKE

Furniture may be keyed alike at no charge. Write "key-alike" in the description of your purchase order for any storage piece you wish to have keyed alike.

Using the key-alike instructions, order cores and keys as line items on your purchase order. Neutral Posture will select key numbers from the standard range of 226 – 425. Key numbers will not be repeated unless over 199 sets are ordered.

There is no charge for key-alike orders if placed with the furniture order.

If product is ordered and shipped random-keyed, additional lock cores for key-alike are billable.

KEYS

A key is shipped with every lock core. 199 Key numbers are available. For numbers above 199, contact Sales Support. Additional keys and key blanks are available.

MASTER KEYING

Neutral Posture locks can be controlled by means of a master key. There is no additional per-lock charge for master keying. Master keys must be ordered separately.

INSTALLING LOCK CORES

Lock cores can be installed or removed in the field by using a change key. Cores must be in the unlocked position to be removed. See service parts for change key pattern number and pricing.

SERVICE PARTS

MODEL #	DESCRIPTION	LIST
NLCKE_ _ _	Shrouded Key (<i>Specify key number desired</i>)	\$18
NAKC	Change Key	\$18
NKM	Master Key	\$18

NOTE: A letter of approval on company letterhead from the client must accompany all orders for master keys.

NOTE: Neutral Posture locks/keys are not compatible with Knoll Equity pedestals/double pedestals.

HOW TO SPECIFY KEY-ALIKE

Following is an example of how to specify key-alike for a cluster of 10 workstations.

STEP 1

Using the project floor plan, count the number of locks in each workstation.

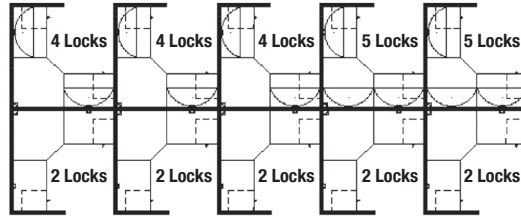

STEP 2

Count the number of workstations with the same quantity of locks. Group together the workstations with a like number of locks.

- 5 workstations with 2 locks per station
- 3 workstations with 4 locks per station
- 2 workstations with 5 locks per station

STEP 3

For the first group (5 sets of 2 locks), enter the number of workstations in the quantity column.

QTY	MODEL #	DESCRIPTION	UNIT LIST	EXT LIST
5	NSPEC 2	Set of 2 cores/keys	N / C	N / C

STEP 4

Then enter the pattern number "NSPEC_ _" and add a suffix for the number of locks for that group (i.e., for 2 locks per station, add the suffix "2"). Up to 30 lock cores are available in a set (i.e., NSPEC 30).

QTY	MODEL #	DESCRIPTION	UNIT LIST	EXT LIST
5	NSPEC 2	Set of 2 cores/keys	N / C	N / C

STEP 5

Repeat for other groups.

QTY	MODEL #	DESCRIPTION	UNIT LIST	EXT LIST
5	NSPEC 2	Set of 2 cores/keys	N / C	N / C
3	NSPEC 4	Set of 4 cores/keys	N / C	N / C
2	NSPEC 5	Set of 5 cores/keys	N / C	N / C

Your key instructions are complete.

Neutral Posture will select key numbers for each set from 199 available numbers.

For additions to existing installations, specify desired key numbers in the description.

EQUITY

In order to specify an Equity locking component with an "H" series core, apply an "A" suffix to the Equity Base pattern number.

All keyed locks in the Equity system are randomly* keyed, as a standard offering. For those requiring all locks within a workstation (or group of workstations) to be keyed alike, Equity also offers a key-alike option.

EQUITY LOCKING COMPONENTS

Identify the cabinets to be keyed alike by adding the suffix "P" to the standard catalog number (i.e., EC20F36AP indicates a key-alike EC20F36A cabinet). The cabinet will be factory-prepared with the hardware mechanisms excluding the lock core and key. List price will be reduced by \$22.

MULTIPLE KEY-ALIKE PACKAGES

For multiple keys of the same number, specify ALCKE - (number of keys desired, from 2 to 8.)
 Price is: Number of Keys x \$22. (i.e.: ALCKE-5 Pkg. of five cores with keys = \$110.00)

LOCK CORES

The same lock core fits all Equity cabinets and pedestals but is different from the "N" series core. Order the lock cores required separately (ALCKE series). Cores are numbered sequentially, with up to 250 different combinations available (ALCKEH6001- ALCKEH6250). Use one line item for each quantity of lock cores to be keyed alike. Series H6001-H6100 are standard lead-time.

MASTER KEY

A master key (AKM) is available that will unlock all cabinets and pedestals with the same prefix letter, for

example: H6001, H6002. A single key is supplied and priced, as shown below.

DESCRIPTION	CATALOG NUMBER	LIST
Equity Lock and Keys	ALCKE(H6___)	\$22
Change Key	AKC	18.
Master Key	AKM	18.

SHIPMENT

Additional lead time of 2-4 weeks may apply when more than 100 lock sequences are specified for key-alike (contact Sales Support for current lead times).

The key-alike core and keys are shipped separately from the components for field installation in the appropriate workstation components.

*Randomly keyed means that no attempt is made to assure that locks have the same number or that they are, in fact, different.



NeutralPosture

Women Owned Small Business

ISO 9001:2008 Approved NeutralPosture.com

BIFMA e3/LEVEL 3904 N. Texas Ave.

Made in the U.S.A. Bryan, TX 77803



T 979.778.0502

F 979.778.0408