

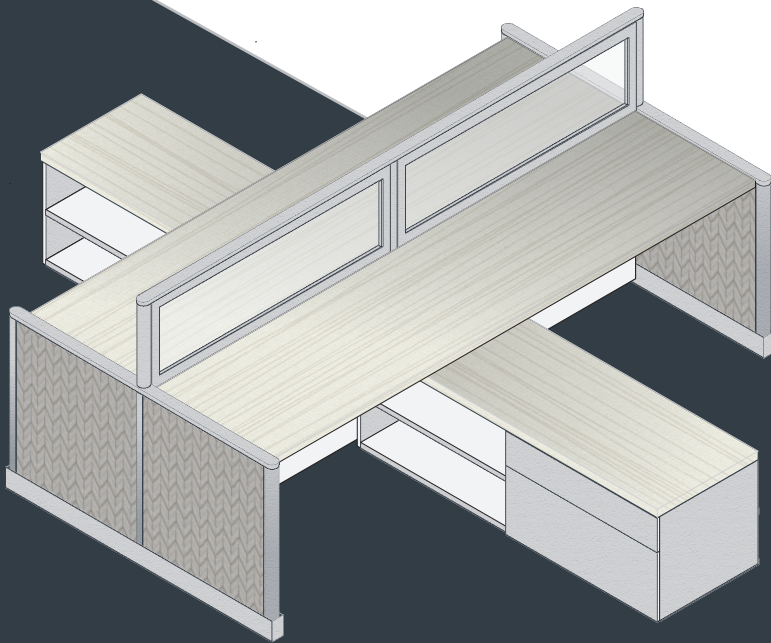

NeutralPosture

Equity^{NP}



2016

PRICE BOOK

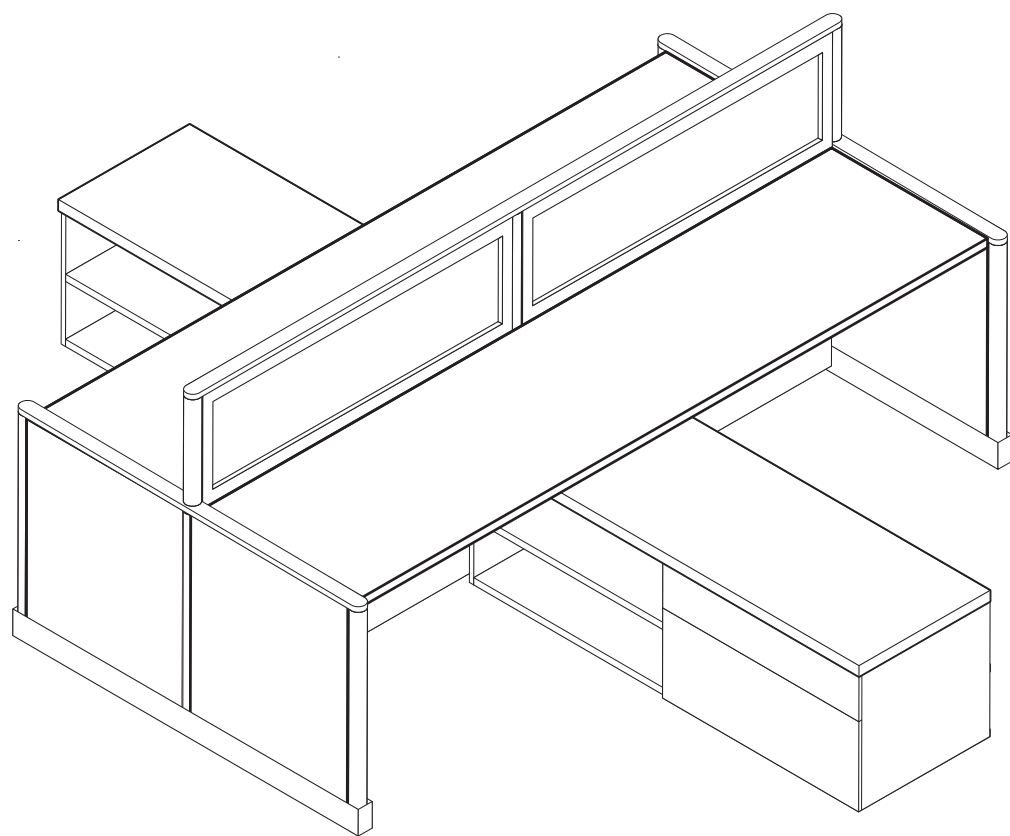

TABLE OF CONTENTS

GENERAL INFORMATION	4	PANELS	16	ELECTRICAL	44
Panels	4	Features	16	How to Order	44
Power	4	Construction	16	Infeeds	46
Raceway	4	Surface Materials	16	Technical Data	47
Environmental Impact	4	Fabric Panels	18 – 19	Ceiling Infeeds	48
Storage	4	Insert Panels	20 – 21	Base Infeeds	49
Legacy Customers	4	Post Assemblies	22 – 23	Components	50
		End Kits	24	Jumper	51
SUSTAINABLE DESIGN	5	Wall Starter/Wall Mounted Channel	25	Knock-out Replacement Cover	52
NP's Green Manufacturing Process	5	Posts (Multi-Height)	26	Desktop Data & Power	53
NP's Green Shipping Initiatives	5	Connectors/Shrouds	27		
TERMS AND CONDITIONS	6	STACK-ON PANELS	28		
Ordering	6	Components	28		
Pricing	6	Stack-on Panel Connectors	28		
Taxes	6	Spedifying Stack0on	28		
Lead Time	6	Stack-on Diagram	29		
Storage Fee	6	Stack-on Configurations	30 – 31		
Shipping	6	Fabric with slots	32 – 33		
Accessorial Charges	6	Fabric without slots	34 – 35		
Freight Damage	7	Insert with slots	36 – 37		
Returns	7	Insert without slots	38 – 39		
Warranty Claims	7	Stack-on Posts	40		
Customer's Own Material	7	Panel Accessories	41		
Delay/force Majeure	7	Add-on Screens	42		
Compliance with Law	7	Privacy/Modesty Panels	43		
Warranty	8				
General Information	8				
Key Alike Program	9				
GSA Contract Overview	10				
GSA Contract Details	11				
Wall Mounting Suggestions	12				
Wall Mounting Details	13				
FINISHES	14				
Fabrics	14				
Laminates	14				
Edge Bands	14				
Paints	14				
Plexiglass	14				
CUSTOM FINISHES PROGRAM	15				
Customer's Own Fabrics	15				
Customer's Own Laminates	15				
Custom RAL Paint Finishes	15				

WORKSURFACES	54
Features	54
Wiring & Cabling	54
Edge Detail	54
Surface Materials	54
General Info	56
Support Information	57
Grain Direction	58 – 59
Straights	60 – 61
Corners	62
Extended Corners	63
Corner Peninsulas	64
Peninsulas	65
Half Round & Linking	66
Blended Double Corner	67
135° Curved Corner	67
Supports	68 – 69
Panel Supported Height Adjustable	70
120° layout Comparison	71
120° Planning	72 – 73
120°	74 – 75
Transition Tops	76
CASCADE WORKSURFACES	77
Cascade Edge	77
Straights	78
Corners & Extended Corners	79
Corner Peninsulas	80
Waves	81
Rounds	82
Accessories	83
COUNTER CAPS	84
Straights	84
Corners	85
PANEL SUPPORTED STORAGE	86
Shelves	86
Overheads	87
Wall Mounted Channel	88
Task Lights	89
TABLES	90
Features	90
Construction	90
Surface Materials	90
Round & Squares	92
Rectangle & Ovals	93
Legs & Bases	94
Privacy/Modesty Panels	95

STORAGE	96
Accessories	98
Accessories Availability	99
PEDESTALS	100
Features	100
Construction	100
Pull Styles	100
Surface Materials	100
Pedestals	102 – 103
LATERALS	104
Features	104
Construction	104
Pull Styles	104
Surface Materials	104
Laterals	106
Lateral – Common Tops	107
TOWERS	108
Features	108
Construction	108
Pull Styles	108
Surface Materials	108
24" Wide	110
24" Wide – Side Access	111
15" Wide	112
15" Wide – Side Access	113
CREDENZAS	114
Features	114
Construction	114
Pull Styles	114
Surface Materials	114
Credenzas	116
Accessories	116
Credenza – Drawers	117
Credenza – Shelves	117
Credenza – Common Tops	117
CABINETS	118
Features	118
Construction	118
Pull Styles	118
Surface Materials	118
Cabinets	120 – 121
LOCKERS	122
Features	122
Construction	122
Pull Styles	122
Surface Materials	122
Lockers	124 – 125
BOOKCASES	126
Features	126
Construction	126
Surface Materials	126
Bookcases	128 – 129

WORKPLACE ACCESSORIES	130
Keyboard Trays	132
Keyboard Arms	132
Easy Combos	133
Monitor Arms	134
Monitor Arm Attachments	134
CPU Holders	135
Accessories	135
Anti-Fatigue Floor Mats	135

General Information

PANELS

Width dimension of all panels is centerline to centerline of adjacent panel connectors.

Panel thickness is 1½". Panel thickness at the base covers is 2".

FABRIC PANELS

Fabric panels incorporate a mineral wool core construction. Fabric panels are acoustical and fully tackable. The base raceway is nominally 5" high.

INSERT PANELS

Insert panels are constructed with a tapered aluminum frame that is mitered in the corners. Insert panels may be ordered with plexiglass, laminate or as an open frame for complete accessibility through the panel.

STACK-ON PANELS

Stack-on panels connect on the top of any standard panel to provide additional privacy or new aesthetic options and are also load bearing.

PANEL CONNECTORS

Panel connectors are 1½" diameter and required at every panel connection and panel end (except when postless end assembly is used). Posts are painted to match the selected trim finish and include an adjustable glide on the bottom for leveling.

POWER

Fabric and insert panels accept electrical components.

Equity panels distribute power through the office and directly to the individual workstation through field-installed modular, electrical wiring components in the base of the panels. The panel base is factory prepared to accept a terminal block in a centered location where two 20-amp receptacles can be installed; one on each side of a panel, arranged back-to-back. An auxiliary side mount duplex receptacle is also available and plugs directly into the side of the terminal block connector end when a second duplex receptacle is required.

RACEWAY

The panel base cover provides openings for receptacles and/or communication outlets, which can be covered when not in use.

All panel bases provide a cable management segment to facilitate lay-in of workstation cables and cords.

CABLE CAPACITY

ELECTRICAL FILL	WITH		WITHOUT	
	100%	40%	100%	40%
Cat 5	36	14	102	40
Cat 6	28	11	80	32

ENVIRONMENTAL IMPACT

Equity takes great pride in providing one of the most environmentally friendly furniture systems available on the market today.

The steel and plastic materials used to construct Equity can be recycled after the product's life. The system is also designed to be cleaned with low environmental impact materials.

The clean technology used to manufacture the Equity system results in negligible off-gassing from the product.

STORAGE

All storage components come standard locking.

Master key and key alike are available upon request.

LEGACY CUSTOMERS

Neutral Posture offers legacy products for existing Equity which was ordered before February of 2016. Please contact Sales Support to obtain a copy of the price book which includes these legacy products.

For any code compliance testing data, please contact your Sales Support Representative.

Building an effective Green Program takes a company-wide effort, but we think it's worth the effort to ensure that our manufacturing process leaves the smallest possible footprint on the environment. Neutral Posture products are designed and manufactured to support a long and useful product life. Our products, if need be, can withstand repeated service, repairs and handling; and our products are made with standardized parts and components which make replacing worn out parts easy and as green as possible.

We continually work with many 3rd party organizations to firmly establish a quality Sustainability Program.

- BIFMA level® Certification
- SCS Indoor Advantage Gold Certification
- LEED
- Underwriters Laboratories (UL)
- Canadian Standards Association (CSA)
- Occupational Safety and Health Administration (OSHA)
- ISO 9001:2008

GREEN MANUFACTURING PROCESS

Neutral Posture is highly efficient in its manufacturing process. New roll forming machines can change between parts with zero scrap. The company has also established a 100% solid waste diversion goal for its manufacturing process and is very close to reaching it. Current manufacturing efforts recycle process water and refrain from using hazardous process chemicals.

PLASTIC

Neutral Posture uses plastic which contains up to 25% pre-consumer recycled plastics. The majority of the plastics used in Neutral Posture products are #3 & #7 plastics and can be recycled in many areas.

STEEL & ALUMINUM

Neutral Posture products contain steel and aluminum that is 100% recyclable. Additionally, up to 25% of this steel comes from pre-consumer recycled product. Aluminum maintains a high scrap value and is known for having a very long working life.

FABRIC

Neutral Posture maintains an excellent supply of green fabrics. These fabrics are made from pre- and post-consumer recycled materials. Some fabrics contain 100% recycled materials and continues to divert recycled plastic from landfills, turning it into beautiful designs.

PANEL INNER

Neutral Posture uses mineral wool, spun from basalt and volcanic rocks to provide lightweight, sound resistant panels. These mineral wool inserts are considered rapidly renewable products.

WOOD

Wood worksurfaces and panels use 100% recycled/recovered wood fiber. All adhesives used in these products are virtually VOC-free and pass stringent emission standards.

GREEN SHIPPING INITIATIVES

Neutral Posture holds their freight carrier partners accountable to similar criteria as suppliers, however, due to the immense impact freight companies have on the environment, all carriers must also become a partner in the Environmental Protection Agency (EPA) SmartWay program within one year of service. All freight carriers are screened through a logistics company and become a partner associate with Neutral Posture based on annual evaluation reports.

PACKAGING OPTIONS

Our cardboard shipping boxes are produced from 45% recycled material and 100% of the materials come from renewable pulp sources. For large orders, customers can choose to use a box made from 100% recycled materials for an upcharge.

A LONG AND HEALTHY PRODUCT LIFE

Neutral Posture products are made to last, as is evidenced by our limited lifetime warranty. Neutral Posture has been around since the 1980s and it is not unusual to find original products from our first year of production in perfect working condition. Although we are continually improving our products, we allow for retrofitting of earlier generations. This allows the customer to upgrade individual components as desired without having to discard the product they already have or purchase a new one. This helps avoid filling landfills with used chairs and is another way in which Neutral Posture customers contribute to their immediate health and wellbeing as well as the continued wellness of our environment.

For more information about Neutral Posture's sustainable design, visit NeutralPosture.com/sustainability

TERMS AND CONDITIONS

For all non-rated or new accounts, payment terms are Cash in Advance (C.I.A.) until credit has been approved or rated. Please send full credit information and references and allow time for Credit Department approval.

For all established accounts, payment is due within thirty (30) days from the invoice date. Neutral Posture (NP) reserves the right to change or cancel the terms of sale based on volume, credit rating and/or credit information. Prepayment, whole or in part, may be requested at any time at the discretion of the corporate office. For orders greater than \$100,000 net, a fifty percent (50%) deposit is due at the time of order placement, with the remainder due within thirty (30) days of the date of invoice.

Past due accounts are subject to a 1.5% late charge or maximum amount permitted under local law, for each thirty (30) days the outstanding balance remains open after the due date.

Withholding of payments based on carrier damages, shortages or other disputes is illegal and subject to charges.

Neutral Posture does not accept credit cards.

ORDERING

All orders must be in writing; faxed, e-mailed or mailed. The product pattern number(s) contained in the order acknowledgment shall be the final expression of the order. A purchase order is not binding on NP until customer has received NP's order confirmation or acknowledgment. Orders must have a contact name and phone number. Orders may not be canceled without written consent of Neutral Posture.

To expedite complete/correct entry of your order, be certain all pattern numbers, quantities, colors and area identifications are completely specified. Also, include complete purchase order number(s), bill-to and ship-to addresses, a contact name and specific factory shipping dates required.

Orders should be sent to:
Neutral Posture, Inc
3904 N Texas Avenue Bryan, TX 77803
979.778.0502 (Option 2)
800.446.3746
979.778.0408 FAX
E-mail: oe@neutralposture.com

When an order is received, it is assigned a scheduled ship date. That date is shown on the customer's acknowledgment.

Purchase orders may not be changed or canceled, in whole or in part, without prior written consent of NP. Changes may affect delivery dates. Expenses incurred because of changes shall be charged to customer. In the event of cancellations, customer will be liable for reasonable cancellation charges established by NP. Orders for special product, orders including customer's own material (COM) and orders pursuant to expedited delivery programs, may not be canceled.

A minimum of 3% of net expedite fee will be charged for orders requiring less than standard lead times.

PRICES

Prices are subject to change without notice. List prices shall be those in effect on the date of receipt of purchase order unless shipment is requested more than ninety (90) days after order entry in which case prices in effect on the date of shipment apply. Prices in effect at time of shipment prevails in the event of a discrepancy.

TAXES

All sales, use, excise and other taxes applicable to the sale of the products shall be paid by customer. If customer claims an exemption from any tax, customer shall submit to NP the appropriate exemption certificates.

LEAD TIME

Please contact Sales Support for current lead time at customerservice@neutralposture.com or 979.778.0502.

STORAGE FEE

Any changes made by the customer to postpone the delivery date on orders which have already gone into production, will be charged a storage fee. This fee will be applied to both partially and fully built orders. NP will advise of fee prior to applying charge.

SHIPPING

Most NP products include free shipping. All standard discount orders are F.O.B destination delivered by parcel or prepaid freight to commercial shipping points located within the forty-eight (48) contiguous United States, District of Columbia and within Canada, excluding the Yukon, Northwest Territories, Nunavut and Newfoundland. NP will designate the shipping mode and carrier based on geographical location and best service defined by our Logistics Department.

For orders shipping outside the forty-eight (48) contiguous United States, District of Columbia and within Canada, excluding the Yukon, Northwest Territories, Nunavut and Newfoundland, customer pays shipping from port of embarkation to destination and order will be shipped "best way". Customer will incur additional charges if they choose to specify a freight carrier.

Even though free shipping does apply to most domestic orders, in some cases accessorial charges may apply for specialized freight services beyond normal pick up, transport, and delivery such as limited access, high security, re-consignment and unusual wait times. Consignee will be responsible for paying accessorial charges relating to their orders. The following list includes, but is not limited to, accessorial charges that will apply to domestic orders. Please contact Sales Support at customerservice@neutralposture.com for a quote.

Accessorial Charges (Net)

- Inside Delivery/Pick Up
- Lift Gate Required
- Limited Access Delivery
- Notification/CBD
- Residential Delivery
- Ship Fully Assembled
- Pre-delivery Notification
- Re-delivery/Return Trip

TERMS AND CONDITIONS

FREIGHT DAMAGE

Upon receipt of shipment, check delivery for shortages or signs of damage. If a problem is discovered, bring it to the driver's attention immediately. If any of the goods called for on the Bill of Lading are shorted or damaged, consignees should not accept them until the carrier makes a notation on the freight bill of the shorted or damaged goods. The more precise your notation, the easier the claim can be resolved. NP's responsibility ceases when the consignee signs the freight delivery receipt as received in good condition. Shipping claims must be made within thirty (30) days of shipment delivery.

RETURNS

The return of product without written authorization by NP shall not be accepted. All merchandise returns must be pre-approved by the corporate office and sent freight prepaid. Contact the Warranty Department, warrantyrequest@neutralposture.com, to receive a Return Merchandise Authorization (RMA) number for any return. RMAs are valid for thirty (30) days and any returned merchandise without a RMA number will be refused.

No deductions from any NP invoices can be made for return merchandise until it is approved by the corporate office. No deductions will be honored until returned goods are processed through our Quality Control Audit.

All returns for canceled orders must be pre-approved by the corporate office and sent freight prepaid. No returns will be authorized unless our inventory allows it, the parts are in good reusable condition and it was sold within the last thirty (30) days. Authorized seating returns will be charged a thirty percent (30%) (twenty percent (20%) for GSA) restocking fee, by agreement, to cover handling, inspection, stocking and repackaging. Authorized systems returns are subject to a forty-five percent (45%) of list restocking charge. Products not currently offered for sale by NP (including COM) shall not be authorized for return. All returned products must be unused, in original condition and in the original NP packing cartons. No refund or credit will be given for damaged products.

WARRANTY CLAIMS

Neutral Posture reserves the right to specify that items or parts claimed to be defective, be returned to the factory for our inspection. If the claim is justified, repair or replacement of defective parts under warranty will be made through NP at no cost to the customer. NP will, at its discretion, reimburse the furniture dealer for labor (actual costs only) on warranty parts. The furniture dealer must submit a quote to be approved prior to service. If approved, the furniture dealer must then submit an invoice to NP for reimbursement after the service is completed. Freight for products and parts covered under warranty will be covered for the forty-eight (48) contiguous states, the District of Columbia and Canada, excluding the Yukon, Northwest Territories, Nunavut and Newfoundland, with the method of shipping at NP's discretion. All claims must include the product serial number. NP will have no warranty obligation if the product was subjected to abuse, alteration, misuse, negligence or accident or if the user fails to perform the proper maintenance for the product.

CUSTOMER'S OWN MATERIAL

A customer who requests a fabric or other surface material not standard to NP's line of products (COM), must submit samples of the requested material to NP prior to entry of a customer order. NP shall determine if the material is suitable to its manufacturing processes and meets any requirements of Underwriters Laboratories and/or Canadian Standards Association. If the COM is acceptable, NP will then establish a price for using the COM. For a description of the procedures for submitting samples and testing, contact Sales Support. NP shall have no responsibility for the appearance, condition, performance, durability, colorfastness or any other physical attribute of the COM. Customer shall indemnify and hold NP harmless for any damages, injuries or losses arising out of or related to use of the COM on the product.

DELAY/FORCE MAJEURE

Neutral Posture shall not be liable for failure to perform or for delay in performance due to fire, flood, strike or other labor difficulty, act of God, act of any governmental authority or of the customer, riot, embargo, fuel or energy shortage, wrecks or delay in transportation, inability to obtain necessary labor, materials or manufacturing facilities from usual sources or failure of suppliers to meet their contractual obligations, or due to any cause beyond its reasonable control. If any such event occurs, Neutral Posture may extend delivery dates by a period of time necessary to overcome the effect of such delay, allocate available product or cancel any purchase order.

COMPLIANCE WITH LAW

Customer is solely responsible for compliance with all applicable federal, state and local laws, ordinances, regulations, rules and standards relating to the installation, maintenance, use and operation of the products.

Selling Policy

WARRANTY

Neutral Posture warrants to the original purchaser only that the products Neutral Posture manufactures and sells to purchaser are free of defects in workmanship and materials, during the applicable warranty period set forth below.

This comprehensive warranty applies to all products installed or reconfigured by an authorized installer.

Warranty period set forth below is for 24-hour, 7 days a week, multi-shift use. Should any failure occur to a product listed below during the applicable warranty period from the date of shipment, Neutral Posture shall, upon prompt written notice, repair or replace, at its option, the affected part or parts.

PRODUCT AND PERIOD OF WARRANTY

Lifetime

Panels and panel connector parts, high pressure laminate worksurfaces, table tops and common tops, storage, modesty/privacy screens

10 Years

Cascade worksurfaces, height adjustable worksurface supports (except for gas lift), laminate overhead doors, desktop and storage accessories (unless otherwise specified)

5 Years

Table bases, tapered table legs, anti-fatigue mats, operational parts, controls, electrical, lighting (except light ballasts, bulbs and power supply), special or custom product, height adjustable worksurface support gas lift

3 Years

Electric height adjustable bases (including motor), fabric

1 Year

Light ballasts, bulbs and power supply

This warranty does not apply to:

- Damage caused by a carrier.
- Normal wear and tear or acts or omissions of parties other than Neutral Posture (including user modification, improper use or installation of products).
- COM or other third party materials applied to products.
- Products not installed by or under the auspices of a Neutral Posture Dealer.
- Dramatic temperature variations or exposure to unusual conditions.
- Changes in surface finishes including colorfastness due to aging or exposure to light.

The express warranties contained herein are in lieu of all other warranties, express or implied, including any warranties of merchantability and fitness for particular purpose and all other warranties arising from course of dealing or usage of trade.

The remedies provided above are the customer's sole remedies for any failure of Neutral Posture to comply with its obligations regarding the workmanship of its products. Correction of any nonconformity in the manner and for the period of time provided shall constitute complete fulfillment of all liabilities of Neutral Posture, with respect to or arising out of the product furnished hereunder.

GENERAL INFORMATION

CERTIFICATION

Independent tests show that Equity components meet or exceed current ANSI/BIFMA X5.6 Panel System and ANSI/BIFMA X5.9 Storage Unit standards. Electrical components are UL listed. Panels have tested to NRC ratings of 0.75.

SCS INDOOR ADVANTAGE CERTIFICATION

The Equity product line is certified by SCS Global Services for indoor air quality.

DESIGN

NP reserves the right to make changes and improvements in design and materials and to discontinue parts and components at the discretion of NP.

WOMEN'S BUSINESS ENTERPRISE (WBE)

This certification is administered by the Women's Business Enterprise National Council (WBENC) and is used by most large corporations to qualify potential vendors as credible diversity suppliers.

WOMAN OWNED SMALL BUSINESS (WOSB)

The U.S. Small Business Administration's WOSB Federal Contract Program provides greater access to federal contracting opportunities for WOSBs. The program allows contracting officers to set aside specific contracts for certified WOSBs and helps federal agencies achieve the existing statutory goal of five percent of federal contracting dollars being awarded to WOSBs. NP is certified as a WOSB.

HISTORICALLY UNDERUTILIZED BUSINESS (HUB)

The Texas Historically Underutilized Business (HUB) program encourages the use of HUBs in state procurement and provides information to minority and woman-owned businesses on the state's procurement process.

BUSINESS AND INSTITUTIONAL FURNITURE

MANUFACTURER'S ASSOCIATION

NP is a member of the Business and Institutional Furniture Manufacturer's Association (BIFMA). Tests developed by BIFMA and approved by the American National Standards Institute (ANSI) determine the strength and durability of office furniture in its everyday use. Although this testing does not serve as a warranty or guarantee, NP standard products within this price list meet or exceed applicable ANSI/BIFMA X5.6 Panel Systems and ANSI/BIFMA X5.9 Storage Unit standards. Combinations of options added on to the standard products may not meet ANSI/ BIFMA standards. Those combinations which do not meet ANSI/BIFMA standards are not available on GSA. Additionally, Equity is BIFMA level 1 certified. For more information, contact Sales Support at customerservice@neutralposture.com.

GENERAL INFORMATION

Following is the Neutral Posture key lock policy, applicable to all products.

Neutral Posture pedestals, overheads, and storage cabinets ship without lock cores installed. The locks are field installed. If your purchase order does not specify key-alike you will automatically receive random lock cores with your order.

Neutral Posture furniture can be keyed-alike or random keyed.

KEY-ALIKE

Furniture may be keyed alike at no charge. Write "key-alike" in the description of your purchase order for any storage piece you wish to have keyed alike.

Using the key-alike instructions, order cores and keys as line items on your purchase order. Neutral Posture will select key numbers from the standard range of 226 – 425. Key numbers will not be repeated unless over 199 sets are ordered.

There is no charge for key-alike orders if placed with the furniture order.

If product is ordered and shipped random-keyed, additional lock cores for key-alike are billable.

KEYS

A key is shipped with every lock core. 199 Key numbers are available. For numbers above 199, contact Sales Support. Additional keys and key blanks are available.

MASTER KEYING

Neutral Posture locks can be controlled by means of a master key. There is no additional per-lock charge for master keying. Master keys must be ordered separately.

INSTALLING LOCK CORES

Lock cores can be installed or removed in the field by using a change key. Cores must be in the unlocked position to be removed. See service parts for change key pattern number and pricing.

SERVICE PARTS

MODEL #	DESCRIPTION	LIST
NLCKE_ _ _	Shrouded Key (<i>Specify key number desired</i>)	\$18
NAKC	Change Key	\$18
NKM	Master Key	\$18

NOTE: A letter of approval on company letterhead from the client must accompany all orders for master keys.

NOTE: Neutral Posture locks/keys are not compatible with Knoll Equity pedestals/double pedestals.

HOW TO SPECIFY KEY-ALIKE

Following is an example of how to specify key-alike for a cluster of 10 workstations.

STEP 1

Using the project floor plan, count the number of locks in each workstation.

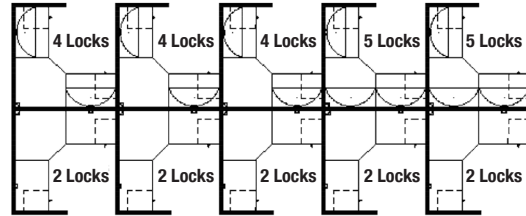

STEP 2

Count the number of workstations with the same quantity of locks. Group together the workstations with a like number of locks.

5 workstations with 2 locks per station
 3 workstations with 4 locks per station
 2 workstations with 5 locks per station

STEP 3

For the first group (5 sets of 2 locks), enter the number of workstations in the quantity column.

QTY	MODEL #	DESCRIPTION	UNIT LIST	EXT LIST
5	NSPEC 2	Set of 2 cores/keys	N / C	N / C

STEP 4

Then enter the pattern number "NSPEC_ _" and add a suffix for the number of locks for that group (i.e., for 2 locks per station, add the suffix "2"). Up to 30 lock cores are available in a set (i.e., NSPEC 30).

QTY	MODEL #	DESCRIPTION	UNIT LIST	EXT LIST
5	NSPEC 2	Set of 2 cores/keys	N / C	N / C

STEP 5

Repeat for other groups.

QTY	MODEL #	DESCRIPTION	UNIT LIST	EXT LIST
5	NSPEC 2	Set of 2 cores/keys	N / C	N / C
3	NSPEC 4	Set of 4 cores/keys	N / C	N / C
2	NSPEC 5	Set of 5 cores/keys	N / C	N / C

Your key instructions are complete.

Neutral Posture will select key numbers for each set from 199 available numbers.

For additions to existing installations, specify desired key numbers in the description.

GSA Contract Overview

GSA CONTRACT

We have had a contract with GSA for over 20 years and they continue to be our most favored customer.

NP is dedicated to helping government agencies meet their facilities and acquisition needs. NP is registered with the Central Contractor Registry (CCR) with ORCA certifications, has an assigned cage code of OUTL8 and is eligible to receive federal contract awards. NP is also recognized as a Woman Owned Small Disadvantaged Business by the Small Business Administration.

WOMAN OWNED SMALL BUSINESS (WOSB)

The U.S. Small Business Administration (SBA) has issued the Final Rule to amend its regulations governing small business contracting procedures. The SBA has increased the emphasis and awareness of contracting mandates regarding the new 5% spend mandate for WOSB similar to those in place for 8a, SDV and HUB Zones businesses.

As a WOSB, woman owned office furniture manufacturer, we have a Packaged Office contract that includes many great manufacturing partners. We are also willing to team with other manufacturers to help support strong GSA Dealers and meet the needs of our customers. As a WOSB, NP is perfectly positioned with a strong Packaged Office contract and partners to capture this business.

For more information please visit
NeutralPosture.com/WOSB

GSA OVERVIEW

GSA Contract# GS-27F-0014Y

Schedule 71 – Furniture

SIN 71-1	Packaged Office
SIN 71-205	Chairs-Dining Room, Desk, Side, Period Style and Bar Stools
SIN 711-1	Furniture Systems and Workstation Clusters
SIN 711-11	Tables and Accessories
SIN 711-18	Multipurpose Seating
SIN 711-19	Stacking Chairs and Dollies
SIN 711-2	Worksurfaces, Workstations, Computer Furniture and Accessories
SIN 711-3	Filing and Storage Cabinets, Shelves, Mobile Carts, Dollies, Racks & Accessories
SIN 711-91	Project Management (Furniture Related)
SIN 711-94	Office Design/Layout Services
SIN 711-95	Installation services

NAICS CODES

337214	Office Furniture (except wood) Manufacturing
337211	Wood Office Furniture Manufacturing
337127	Institutional Furniture Manufacturing
423210	Furniture Merchant Wholesalers

NP products may be found on GSA Advantage and AF Advantage.

- 1a. Special Item Numbers Awarded**
- SIN 711-1 Furniture Systems and Workstation Clusters
 - SIN 711-11 Tables and Accessories
 - SIN 711-18 Multipurpose Seating
 - SIN 711-19 Stacking Chairs and Dollies
 - SIN 711-95 Installation Services
 - SIN 711-2 Worksurfaces, Workstations, Computer Furniture and Accessories
 - SIN 711-3 Filing and Storage Cabinets, Shelves, Mobile Carts, Dollies, Racks & Accessories
 - SIN 711-91 Project Management (Furniture Related)
 - SIN 711-94 Office Design/Layout Services
 - SIN 71-1 Packaged Office
 - SIN 71-205 Chairs-Dining Room, Desk, Side, Period Style and Bar Stools

- 1b. Lowest Priced Item**
- SIN 71-1 Call Corporate Office
 - SIN 71-205 ONGO \$336.00
 - SIN 711-1 EP3P29 Single Post \$32.55
 - SIN 711-11 Call Corporate Office
 - SIN 711-18 NCUGG1 Urethane \$151.20
 - SIN 711-19 NSID115 Grade C \$336.00
 - SIN 711-2 Call Corporate Office
 - SIN 711-3 SPTRY Pencil Tray \$5.95
 - SIN 711-95 Not Applicable

- 1c. Installation Rate — SIN 711-1, 711-3, 711-11**
 \$51.50 per hour (non-union inclusive IFF)
 \$106.25 per hour (union inclusive of IFF)
- Project Management Fee — SIN 711-91**
- Senior Project Manager \$75 per hour (inclusive IFF)
 - Project Manager \$55.58 per hour (inclusive IFF)
 - Project Coordinator \$50 per hour (inclusive IFF)

- Design/Layout Fee — SIN 711-94**
 \$65 per hour (inclusive IFF)
 \$85 per hour CADD service (inclusive IFF)

- 2. Maximum Order**
- SIN 71-1 \$5,000,000
 - SIN 71-205 \$1,000,000
 - SIN 711-1 \$500,000
 - SIN 711-11 \$500,000
 - SIN 711-18 \$200,000
 - SIN 711-19 \$200,000
 - SIN 711-2 \$200,000
 - SIN 711-3 \$500,000
 - SIN 711-91 \$150,000
 - SIN 711-94 \$150,000
 - SIN 711-95 \$150,000

- 3. Minimum Order**
 All SINs \$50

- 4. Geographic Coverage**
 CONUS & OCONUS

- 5. Point of Production**
 3904 N. Texas Avenue, Bryan, Brazos County, Texas, USA

- 6. Discount from List Price**
- Seating/Workplace Accessories**
 SIN 711-2, 711-18, 711-19, 711-205 — Discount 58%

- Systems**
 SIN 711-1, 711-3, 711-11 — Discount 65%

- 7. Quantity Discounts**
 No discount tiers have been negotiated.

- 8. Prompt Payment Terms**
 Net 30 Days

- 9. Government Purchase Cards Accepted**
 Visa/Master Card

- 10. Foreign Item**
 None

- 11a. Time of Delivery**
 5 – 90 days after receipt of order

- 11b. Expedited Delivery**
 Expedited delivery available. Contact NP Sales Support.

- 11c. Overnight and 2-day Delivery**
 Available with an upcharge. Contact NP Sales Support.

- 12. F.O.B. Points**
 Destination/CONUS, within the 48 contiguous states and the District of Columbia. Port of embarkation for delivery to Alaska, Hawaii, Puerto Rico, the Virgin Islands and U.S. Government installations overseas.

- 13. Ordering Address**
 Neutral Posture, Inc.
 attn: Order Entry/ * or dealer
 3904 N. Texas Avenue
 Bryan, TX 77803
 979.778.0502
 800.446.3746
 fax 979.778.0408
 oe@neutralposture.com
 * Authorized Dealers should be cited on order

- 14. Payment Address:**
 Neutral Posture, Inc.
 3904 N. Texas Avenue
 Bryan, TX 77803

- 15. Warranty Provision:**
 Neutral Posture's commercial warranty applies.

- 16. Export Packing Charges:**
 Contact NP Sales Support for quote

- 17. Terms and Conditions of Government Purchase Card:**
 Government purchase cards will be accepted for purchases at prices shown in this authorized price list (no additional discount offered).

- 18. Terms and Conditions Of Rental, Maintenance, and Repair:**
 Not applicable

- 19. Terms and Conditions of Installation:**
 Installation and instruction are available from authorized dealers. Please contact your local NP Dealer for pricing.

- 20. Terms and Conditions of Repair Parts:**
 Repair parts are offered at the agreed upon discount from the NP repair parts price list in effect at the time the repair parts are ordered.

- 11a. Terms and Conditions for Any Other Services:**
 GSA has accepted all of our standard terms and conditions as noted on page 6-7.

- 21. List of Service and Distribution Points:**
 Not applicable

- 22. List of Dealers:**
 Please contact NP, or visit NeutralPosture.com for the name of your nearest authorized Dealer.

- 23. Preventive Maintenance:**
 Not offered or applicable

- 24. Environmental Attributes:**
 Not applicable

- 25. Other Information:**
- | | |
|----------------------------------|-------------|
| Tax Identification Number (TIN): | 74-2983577 |
| DUNS: | 61-0339723 |
| Cage Code: | OUTL8 |
| CEC: | 61134982 |
| SIC/NAICS: | 2522/337214 |

- 26. CCR:**
 NP is registered in System For Award Management (SAM) and Central Contractor Registration (CCR) database.

NOTE: It is mandatory that all Government purchase orders be made out to NP only. Local Dealers are not authorized to accept purchase orders, issue invoices or receive payment of Government funds for these items without serious violation of this Federal Supply Schedule Contract.

WALL MOUNTING SUGGESTIONS

The following information is provided only as a guide, and represents minimum recommendations only. Neutral Posture does not accept responsibility for the attachment of any Neutral Posture product to a Customer's site wall. Wall specification/construction is the responsibility of the Customer and its structural engineer/architect. Failure to properly attach Neutral Posture products to adequate wall structures can lead to property damage and/or personal injury.

You should consult your own structural engineers and/or architects and must not rely on the information provided herein.

It is the responsibility of the Customer and its structural engineers/architects to verify that the permanent structural walls (studs, blocks, solid masonry, etc.) on which the

Neutral Posture products are intended to be mounted are designed appropriately to support the product weight, PLUS 3 lbs. per linear inch for each usable shelf length

NOTE: A cabinet's top is considered a "usable shelf" and MUST be included in the calculation of the total load for an overhead cabinet.

It is the responsibility of the Customer and its structural engineer/architects to specify the fasteners and method for attaching the Neutral Posture supplied wall mounting cleat, bracket, frame, etc. to the supporting wall and to confirm that the installers have adhered to these specifications. For all local building standards and codes, and additional requirements (including, but not limited to, seismic conditions) the Customer should always consult local code agencies.

New Construction

Existing Construction

	Cinder Block or Poured Concrete Masonry Wall	Wood Stud Wall, the studs being FULL HEIGHT to the roof/floor above	Wood Stud Wall, the studs being only Ceiling Height	Steel Stud Wall, the studs being FULL HEIGHT to the roof/floor above	Steel Stud Wall, the studs being only Ceiling Height	
Stud Specification	Wood studs, grade #2 or better, 3 1/2" minimum width, OR Metal studs, minimum 25 gage thickness, 3 5/8" minimum width	The wall must be a minimum of 6" thick, and must be full height to the roof/floor structure above	Wood studs must be Grade #2, or better, 3 1/2" minimum width	Wood studs must be Grade #2, or better, 3 1/2" minimum width	Metal studs must be minimum 25 gage thickness, 3 5/8" minimum width	
Stud Centers	Metal and wood studs must be spaced at 16" c/c maximum.	N/A	Wood studs must be spaced at 16" c/c maximum.	Wood studs must be spaced at 16" c/c maximum.	Metal studs must be spaced at 16" c/c maximum.	
Stud Height	Metal and wood studs must extend upwards, and be securely attached to the roof/floor structure above.			Wood studs must be braced above the ceiling, and be securely attached to the roof/floor structure above Affix #2 grade 'cap' across the top of the studs, then place diagonal studs from the top cap up to underside of the roof/floor structure above.		
Mounting the Neutral Posture Supplied Cleat, Bracket, Frame, etc	<p>Insert a 2" x 6" wood block, #2 grade or better, [or a locally approved flexible wood backing system] horizontally between each of the studs to accommodate the full width of the cabinet and beyond to the next stud.</p> <p>Fasten the wood block to each stud using three screws at the ends of each block.</p> <p>(Fasten the locally approved wood backing system as directed by the manufacturer.)</p> <p>Fasten the Neutral Posture supplied wall mounting cleat, bracket, frame, etc directly to each wood block every 6".</p> <p>For wall mounting structures that have a rectangular frame-like configuration: fasten the top horizontal element of the frame to the wood blocking every 6" and fasten the lower horizontal element to each wall stud, using one fastener per stud.</p>	<p>Fasten the Neutral Posture supplied cabinet wall mounting cleat, bracket, frame, etc. directly to the masonry wall every 6".</p> <p>For wall mounting structures that have a rectangular frame-like configuration: fasten the top horizontal element of the frame to the wall every 6" and fasten the lower horizontal element to the wall every 16".</p>	<p>In the desired location of the cabinet mounting rail, remove an 8" high section of drywall the width of the cabinet and beyond to the next stud.</p> <p>Insert a 2" x 6" wood block, #2 grade or better, horizontally between each of the exposed studs.</p> <p>Fasten the wood block to each stud using three screws at the ends of each block.</p> <p>Replace the drywall and repair as desired.</p> <p>Fasten the Neutral Posture supplied wall mounting cleat, rail, frame, etc directly to the wood block every 6".</p> <p>For wall mounting structures that have a rectangular frame-like configuration: fasten the top horizontal element of the frame to the wood blocking every 6", and fasten the lower horizontal element to each wall stud, using one fastener per stud.</p>	<p>In the desired location of the cabinet mounting rail, remove an 8" high section of drywall the width of the cabinet and beyond to the next stud.</p> <p>Insert a 2" x 6" wood block, #2 grade or better, horizontally between each of the exposed studs.</p> <p>Fasten the wood block to each stud using three screws at the ends of each block.</p> <p>Replace the drywall and repair as desired.</p> <p>Fasten the Neutral Posture supplied wall mounting cleat, rail, frame, etc directly to the wood block every 6".</p> <p>For wall mounting structures that have a rectangular frame-like configuration: fasten the top horizontal element of the frame to the wood blocking every 6", and fasten the lower horizontal element to each wall stud, using one fastener per stud.</p>	<p>In the desired location of the cabinet mounting rail, remove an 8" high section of drywall the width of the cabinet and beyond to the next stud.</p> <p>Insert a 2" x 6" wood block, #2 grade or better, [or a locally approved flexible wood backing system] horizontally between each of the exposed studs.</p> <p>Fasten the wood block to each stud using three screws at the ends of each block.</p> <p>Replace the drywall and repair as desired.</p> <p>Fasten the Neutral Posture supplied wall mounting cleat, rail, frame, etc directly to the wood block every 6".</p> <p>For wall mounting structures that have a rectangular frame-like configuration: fasten the top horizontal element of the frame to the wood blocking every 6", and fasten the lower horizontal element to each wall stud, using one fastener per stud.</p>	<p>In the desired location of the cabinet mounting rail, remove an 8" high section of drywall the width of the cabinet and beyond to the next stud.</p> <p>Insert a 2" x 6" wood block, #2 grade or better, [or a locally approved flexible wood backing system] horizontally between each of the exposed studs.</p> <p>Fasten the wood block to each stud using three screws at the ends of each block.</p> <p>Replace the drywall and repair as desired.</p> <p>Fasten the Neutral Posture supplied wall mounting cleat, rail, frame, etc directly to the wood block every 6".</p> <p>For wall mounting structures that have a rectangular frame-like configuration: fasten the top horizontal element of the frame to the wood blocking every 6" and fasten the lower horizontal element to each wall stud, using one fastener per stud.</p>
Fasten the Neutral Posture supplied wall cleat with...	#10 x 2 1/2" wood screws or equiv. in every mounting hole provided, screwed directly into the wood blocking	3/16" x 3 1/2" masonry screws or equiv. in every mounting hole provided with 1 1/4" embedment, screwed directly into the masonry wall	#10 x 2 1/2" wood screws or equiv. in every mounting hole provided, screwed directly into the wood blocking	#10 x 2 1/2" wood screws or equiv. in every mounting hole provided, screwed directly into the wood blocking	#10 x 2 1/2" wood screws or equiv. in every mounting hole provided, screwed directly into the wood blocking	

Finishes

FABRICS

A

Aerial	Victor	F1206
Candid	Guilford of Maine	F3007
Cross Check	Mayer	F299
Dune	Victor	F4505
Forte	Mayer	F298
Netiquette	Victor	F1241
Off the Grid	Victor	F1233
Pact	Momentum	F0911
Quadrille	Victor	F4701
Quasar	Victor	F4226
Quattro	Mayer	F300
Sprite	Guilford of Maine	F2671
Strata	Mayer	F164

B

Cape Cod	Guilford of Maine	F3073
Dashing	Victor	F1204
Grasscloth	Mayer	F137
Infinity	Momentum	F0914A
Luminary	Mayer	F100
Marathon	Momentum	F0914B
Metallation	Guilford of Maine	F5118
Metro	Guilford of Maine	F3077
Millennium	Momentum	F0914C
Odyssey	Momentum	F0914D
Rattan	Guilford of Maine	F3087
Reverb	Mayer	F421
Tradition	Momentum	F0914E
Tweed	Guilford of Maine	F2737
Verse	Momentum	F0910

D

Echo	Mayer	F388
------	-------	------

LAMINATES

L1

Linen	SS-LN
Grey Mesh	SP-GRM
Soft Gold Mesh	SP-SGM
Mangalore Mango	SW-MGM
Mission Maple	SW-MNM
Sterling Ash	SW-STA
Organic Cotton	SS-OC
Nickle Ev	SS-NEV
Casual Linen	SS-CLN

L2

Astro Strandz	PP-AST
Vapor Strandz	PP-VST
Cosmic Strandz	PP-CST
Asian Sand	PW-ASD
Studio Teak	PW-STK
Shaker Cherry	PW-SCH
Silver Alchemy	PW-SAL
Empire Mahogany	PW-EMH
Biltmore Cherry	PW-BCH

EDGE BANDS

Linen	EB-LN
Grey Mesh	EB-GRM
Soft Gold Mesh	EB-SGM
Mangalore Mango	EB-MGM
Mission Maple	EB-MNM
Sterling Ash	EB-STA
Organic Cotton	EB-OC
Nickle Ev	EB-NEV
Casual Linen	EB-CLN
Astro Strandz	EB-AST
Vapor Strandz	EB-VST
Cosmic Strandz	EB-CST
Asian Sand	EB-ASD
Studio Teak	EB-STK
Shaker Cherry	EB-SCH
Silver Alchemy	EB-SAL
Empire Mahogany	EB-EMH
Biltmore Cherry	EB-BCH
Beige	EB-BEI
Khaki Brown	EB-BRN
Fashion Grey	EB-FGR
Sand	EB-SND
Shadow	EB-SHD
Pepperdust	EB-PPR
Slate Grey	EB-SGR
Grey	EB-GRY
Platinum	EB-PLT
Virtual Design Laminate	EB-VL
Custom Laminate	EB-COL

PAINTS

P1

Cream	201
Designer Beige	202
Grey	203
Jet Black	204

P2

Champagne	301
Platinum	302
Brass	303
Copper	304

PLEXIGLASS

Clear	CL
Ice	IC
Smoked	SM
Translucent	TR

NOT AVAILABLE ON INSERT PANELS

Frost	LF
-------	----

Custom Finishes Program

While Neutral Posture offers a large selection of unique finishes, we understand you might want to create a signature on your project or brand your project. We are offering an easy way for you to provide pricing to your client.

CUSTOMER'S OWN FABRICS

Neutral Posture can apply any UL fire rated fabric. This will add to the lead time as we will require three yards of fabric to test on a panel. Test yardage should be sent to the factory address in Bryan, TX with the project name clearly marked on the label noting test yardage.

Neutral Posture Test Fabric
Attention: Systems Product Manager
3904 N. Texas Ave.
Bryan, TX 77803

We can also grade-in any fabric from any suppliers in the industry. Please contact your sales representative or Sales Support for grade-in pricing. Note that all grade-ins must be pre-approved for suitability before production begins.

CUSTOMER'S OWN LAMINATES

All of Neutral Posture's standard laminates are Wilsonart. For your project, you can select any Wilsonart laminate and use L1 for standard laminates, L2 for their premium laminates and L3 for their custom and virtual library programs. An upcharge may apply for matching edge banding. Please contact your sales representative or Sales Support for more information.

We can also grade-in any laminate from any other supplier. Please contact your sales representative or Sales Support for grade-in pricing. Note that all grade-ins must be pre-approved for suitability before production begins.

CUSTOM RAL PAINT FINISHES

Whether it is an 8 person or 150 person project, use any RAL powder coat colors on your metal products. If you have any questions, please contact your sales representative or Sales Support for more information.

HOW TO PRICE For Each Order

Setup fee per RAL color \$1,100 (NET)
Each item using an RAL color P3 Pricing

Panels

General Info

Step 1 – Model

EP	Equity Panel	3 Beveled N Flat	FA Fabric Panel	W	H	Raceway
EP		N	FA	36	29	K with knockouts N without knockouts

Step 2 – Surface Finish

F298	Forte
F298	

Step 3 – Trim Finish

301	Champagne
301	

FEATURES

HEIGHTS

29" H
41" H
49" H
54" H
61" H
64" H
81" H

WIDTHS

12" W
18" W
24" W
30" W
36" W
42" W
48" W
60" W

THICKNESS

1 1/2"

TOP CAP

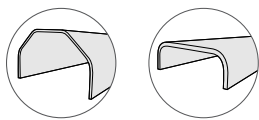

3 – Beveled

N – Flat

RACEWAY

(K) with knockouts
(N) without knockouts

PANEL RATINGS

NRC	.75
STC	11

CONSTRUCTION

FABRIC PANEL FRAME

Galvaneal roll formed steel frame

FABRIC PANEL CORE

Mineral wool
Fiberglass backer

INSERT PANEL FRAME

Extruded aluminum

INSERT PANEL CORE

1/4" Laminate
1/4" Plexiglass
Open Frame

TOP CAP, SLOTTED STANDARD

Cold rolled roll formed steel

TOP CAP CLIP

Spring steel

RACEWAY COVER, RACEWAY BASE & RACEWAY RETENTION CHANNEL

Cold rolled roll formed steel

RACEWAY STANCHIONS

Pressed & folded steel

PANEL HOOKS

Steel

POSTS

Steel tube

POST CONNECTORS

Diecast aluminum

SHROUDS

Pressed & folded steel

SURFACE MATERIALS

ALL PANELS

Trim – Paint

FABRIC PANELS (FA)

Fabric

INSERT PANELS

Plexiglass (PG)

Clear	CL
Ice	IC
Smoked	SM
Translucent	TR

Laminate (LM)

Laminate

Open Frame (OF)

Paint

POSTS, CONNECTORS & SHROUDS

Paint

PANELS

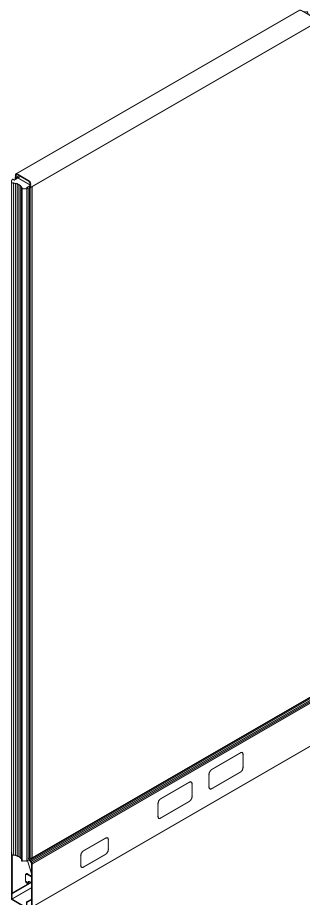

Fabric Panels

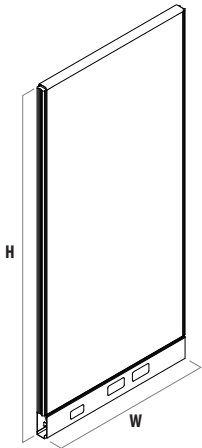

29" H

W	MODEL #	FABRIC								PAINT	
		A	B	C	D	E	F	G	H	P2	P3
12"	EP(3/N)FA1229(K/N)	\$430	\$460	\$500	\$550	\$610	\$680	\$760	\$850	+\$25	+\$50
18"	EP(3/N)FA1829(K/N)	\$480	\$510	\$550	\$600	\$660	\$730	\$810	\$900	+\$25	+\$50
24"	EP(3/N)FA2429(K/N)	\$530	\$560	\$600	\$650	\$710	\$780	\$860	\$950	+\$25	+\$50
30"	EP(3/N)FA3029(K/N)	\$580	\$610	\$650	\$700	\$760	\$830	\$910	\$1,000	+\$25	+\$50
36"	EP(3/N)FA3629(K/N)	\$650	\$710	\$790	\$890	\$1,010	\$1,150	\$1,310	\$1,490	+\$25	+\$50
42"	EP(3/N)FA4229(K/N)	\$690	\$750	\$830	\$930	\$1,050	\$1,190	\$1,350	\$1,530	+\$25	+\$50
48"	EP(3/N)FA4829(K/N)	\$730	\$790	\$870	\$970	\$1,090	\$1,230	\$1,390	\$1,570	+\$25	+\$50
60"	EP(3/N)FA6029(K/N)	\$770	\$830	\$910	\$1,010	\$1,130	\$1,270	\$1,430	\$1,610	+\$25	+\$50

41" H

12"	EP(3/N)FA1241(K/N)	\$480	\$520	\$570	\$630	\$710	\$800	\$910	\$1,040	+\$25	+\$50
18"	EP(3/N)FA1841(K/N)	\$530	\$570	\$620	\$680	\$760	\$850	\$960	\$1,090	+\$25	+\$50
24"	EP(3/N)FA2441(K/N)	\$580	\$620	\$670	\$730	\$810	\$900	\$1,010	\$1,140	+\$25	+\$50
30"	EP(3/N)FA3041(K/N)	\$630	\$670	\$720	\$780	\$860	\$950	\$1,060	\$1,190	+\$25	+\$50
36"	EP(3/N)FA3641(K/N)	\$700	\$780	\$880	\$1,000	\$1,160	\$1,350	\$1,590	\$1,880	+\$25	+\$50
42"	EP(3/N)FA4241(K/N)	\$750	\$830	\$930	\$1,050	\$1,210	\$1,400	\$1,640	\$1,930	+\$25	+\$50
48"	EP(3/N)FA4841(K/N)	\$800	\$880	\$980	\$1,100	\$1,260	\$1,450	\$1,690	\$1,980	+\$25	+\$50
60"	EP(3/N)FA6041(K/N)	\$850	\$930	\$1,030	\$1,150	\$1,310	\$1,500	\$1,740	\$2,030	+\$25	+\$50

49" H

12"	EP(3/N)FA1249(K/N)	\$540	\$580	\$630	\$690	\$770	\$870	\$990	\$1,140	+\$25	+\$50
18"	EP(3/N)FA1849(K/N)	\$590	\$630	\$680	\$740	\$820	\$920	\$1,040	\$1,190	+\$25	+\$50
24"	EP(3/N)FA2449(K/N)	\$640	\$680	\$730	\$790	\$870	\$970	\$1,090	\$1,240	+\$25	+\$50
30"	EP(3/N)FA3049(K/N)	\$690	\$730	\$780	\$840	\$920	\$1,020	\$1,140	\$1,290	+\$25	+\$50
36"	EP(3/N)FA3649(K/N)	\$760	\$840	\$940	\$1,060	\$1,230	\$1,440	\$1,710	\$2,030	+\$25	+\$50
42"	EP(3/N)FA4249(K/N)	\$810	\$890	\$990	\$1,110	\$1,280	\$1,490	\$1,760	\$2,080	+\$25	+\$50
48"	EP(3/N)FA4849(K/N)	\$860	\$940	\$1,040	\$1,160	\$1,330	\$1,540	\$1,810	\$2,130	+\$25	+\$50
60"	EP(3/N)FA6049(K/N)	\$930	\$1,010	\$1,110	\$1,230	\$1,400	\$1,610	\$1,880	\$2,200	+\$25	+\$50

Specify

1. Model #
2. Surface finish
3. Trim finish

Application Notes

Panel is fabric covered. If two different fabrics are used on one panel, price will reflect cost of the most expensive panel fabric.

NOTE: Power duplexes cannot be installed on 12" W panels. Side mount receptacles available in 24" W panels and wider.

Assembly

- Included**
- Panel
 - Top cap
 - Metal raceway covers

Ordered Separately

- Posts
- Panel connectors
- Electrical components

Top Cap Styles

3 – Beveled

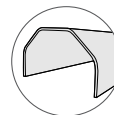

N – Flat

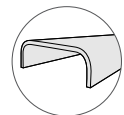

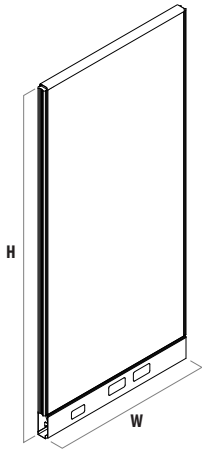

54" H

W	MODEL #	FABRIC								PAINT	
		A	B	C	D	E	F	G	H	P2	P3
12"	EP(3/N)FA1254(K/N)	\$590	\$630	\$680	\$750	\$850	\$960	\$1,090	\$1,250	+ \$25	+ \$50
18"	EP(3/N)FA1854(K/N)	\$640	\$680	\$730	\$800	\$900	\$1,010	\$1,140	\$1,300	+ \$25	+ \$50
24"	EP(3/N)FA2454(K/N)	\$690	\$730	\$780	\$850	\$950	\$1,060	\$1,190	\$1,350	+ \$25	+ \$50
30"	EP(3/N)FA3054(K/N)	\$740	\$780	\$830	\$900	\$1,000	\$1,110	\$1,240	\$1,400	+ \$25	+ \$50
36"	EP(3/N)FA3654(K/N)	\$820	\$910	\$1,010	\$1,150	\$1,360	\$1,590	\$1,860	\$2,190	+ \$25	+ \$50
42"	EP(3/N)FA4254(K/N)	\$870	\$960	\$1,060	\$1,200	\$1,410	\$1,640	\$1,910	\$2,240	+ \$25	+ \$50
48"	EP(3/N)FA4854(K/N)	\$920	\$1,010	\$1,110	\$1,250	\$1,460	\$1,690	\$1,960	\$2,290	+ \$25	+ \$50
60"	EP(3/N)FA6054(K/N)	\$990	\$1,080	\$1,180	\$1,320	\$1,530	\$1,760	\$2,030	\$2,360	+ \$25	+ \$50

61" H

12"	EP(3/N)FA1261(K/N)	\$640	\$690	\$750	\$830	\$940	\$1,060	\$1,200	\$1,370	+ \$25	+ \$50
18"	EP(3/N)FA1861(K/N)	\$690	\$740	\$800	\$880	\$990	\$1,110	\$1,250	\$1,420	+ \$25	+ \$50
24"	EP(3/N)FA2461(K/N)	\$740	\$790	\$850	\$930	\$1,040	\$1,160	\$1,300	\$1,470	+ \$25	+ \$50
30"	EP(3/N)FA3061(K/N)	\$790	\$840	\$900	\$980	\$1,090	\$1,210	\$1,350	\$1,520	+ \$25	+ \$50
36"	EP(3/N)FA3661(K/N)	\$860	\$960	\$1,080	\$1,240	\$1,470	\$1,720	\$2,000	\$2,340	+ \$25	+ \$50
42"	EP(3/N)FA4261(K/N)	\$910	\$1,010	\$1,130	\$1,290	\$1,520	\$1,770	\$2,050	\$2,390	+ \$25	+ \$50
48"	EP(3/N)FA4861(K/N)	\$960	\$1,060	\$1,180	\$1,340	\$1,570	\$1,820	\$2,100	\$2,440	+ \$25	+ \$50
60"	EP(3/N)FA6061(K/N)	\$1,050	\$1,150	\$1,270	\$1,430	\$1,660	\$1,910	\$2,190	\$2,530	+ \$25	+ \$50

64" H

12"	EP(3/N)FA1264(K/N)	\$660	\$710	\$770	\$850	\$970	\$1,100	\$1,250	\$1,430	+ \$25	+ \$50
18"	EP(3/N)FA1864(K/N)	\$710	\$760	\$820	\$900	\$1,020	\$1,150	\$1,300	\$1,480	+ \$25	+ \$50
24"	EP(3/N)FA2464(K/N)	\$760	\$810	\$870	\$950	\$1,070	\$1,200	\$1,350	\$1,530	+ \$25	+ \$50
30"	EP(3/N)FA3064(K/N)	\$810	\$860	\$920	\$1,000	\$1,120	\$1,250	\$1,400	\$1,580	+ \$25	+ \$50
36"	EP(3/N)FA3664(K/N)	\$890	\$1,000	\$1,130	\$1,290	\$1,540	\$1,820	\$2,140	\$2,530	+ \$25	+ \$50
42"	EP(3/N)FA4264(K/N)	\$940	\$1,050	\$1,180	\$1,340	\$1,590	\$1,870	\$2,190	\$2,580	+ \$25	+ \$50
48"	EP(3/N)FA4864(K/N)	\$990	\$1,100	\$1,230	\$1,390	\$1,640	\$1,920	\$2,240	\$2,630	+ \$25	+ \$50
60"	EP(3/N)FA6064(K/N)	\$1,080	\$1,190	\$1,320	\$1,480	\$1,730	\$2,010	\$2,330	\$2,720	+ \$25	+ \$50

81" H

12"	EP(3/N)FA1281(K/N)	\$710	\$770	\$830	\$920	\$1,070	\$1,240	\$1,430	\$1,650	+ \$25	+ \$50
18"	EP(3/N)FA1881(K/N)	\$760	\$820	\$880	\$970	\$1,120	\$1,290	\$1,480	\$1,700	+ \$25	+ \$50
24"	EP(3/N)FA2481(K/N)	\$810	\$870	\$930	\$1,020	\$1,170	\$1,340	\$1,530	\$1,750	+ \$25	+ \$50
30"	EP(3/N)FA3081(K/N)	\$860	\$920	\$980	\$1,070	\$1,220	\$1,390	\$1,580	\$1,800	+ \$25	+ \$50
36"	EP(3/N)FA3681(K/N)	\$1,040	\$1,160	\$1,280	\$1,470	\$1,800	\$2,170	\$2,580	\$3,040	+ \$25	+ \$50
42"	EP(3/N)FA4281(K/N)	\$1,160	\$1,280	\$1,400	\$1,590	\$1,920	\$2,290	\$2,700	\$3,160	+ \$25	+ \$50
48"	EP(3/N)FA4881(K/N)	\$1,250	\$1,370	\$1,490	\$1,680	\$2,010	\$2,380	\$2,790	\$3,250	+ \$25	+ \$50
60"	EP(3/N)FA6081(K/N)	\$1,340	\$1,460	\$1,580	\$1,770	\$2,100	\$2,470	\$2,880	\$3,340	+ \$25	+ \$50

		Top Cap	Panel Type	W	H	Raceway
EP	Equity panel	3 Beveled N Flat	FA Fabric panel	36	29	K With knockouts N Without knockouts
EP		N	FA	36	29	K

Insert Panels

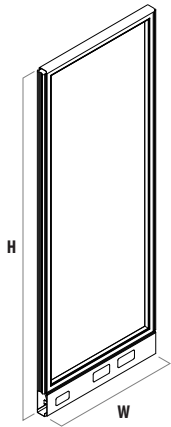

29" H

W	MODEL #	OF	PG	LAMINATE INSERT			PAINT	
				L1	L2	L3	P2	P3
12"	EP(3/N)()1229(K/N)	\$697	\$897	\$897	\$987	\$1,076	+\$25	+\$50
18"	EP(3/N)()1829(K/N)	\$707	\$977	\$977	\$1,075	\$1,172	+\$25	+\$50
24"	EP(3/N)()2429(K/N)	\$717	\$1,047	\$1,047	\$1,152	\$1,256	+\$25	+\$50
30"	EP(3/N)()3029(K/N)	\$737	\$1,097	\$1,097	\$1,207	\$1,316	+\$25	+\$50
36"	EP(3/N)()3629(K/N)	\$757	\$1,147	\$1,197	\$1,317	\$1,436	+\$25	+\$50
42"	EP(3/N)()4229(K/N)	\$777	\$1,197	\$1,297	\$1,427	\$1,556	+\$25	+\$50
48"	EP(3/N)()4829(K/N)	\$797	\$1,277	\$1,397	\$1,537	\$1,676	+\$25	+\$50
60"	EP(3/N)()6029(K/N)	\$837	\$1,377	\$1,597	\$1,757	\$1,916	+\$25	+\$50

41" H

12"	EP(3/N)()1241(K/N)	\$737	\$947	\$947	\$1,042	\$1,136	+\$25	+\$50
18"	EP(3/N)()1841(K/N)	\$747	\$1,047	\$1,047	\$1,152	\$1,256	+\$25	+\$50
24"	EP(3/N)()2441(K/N)	\$757	\$1,147	\$1,147	\$1,262	\$1,376	+\$25	+\$50
30"	EP(3/N)()3041(K/N)	\$777	\$1,247	\$1,247	\$1,372	\$1,496	+\$25	+\$50
36"	EP(3/N)()3641(K/N)	\$797	\$1,347	\$1,347	\$1,482	\$1,616	+\$25	+\$50
42"	EP(3/N)()4241(K/N)	\$817	\$1,447	\$1,497	\$1,647	\$1,796	+\$25	+\$50
48"	EP(3/N)()4841(K/N)	\$837	\$1,497	\$1,747	\$1,922	\$2,096	+\$25	+\$50
60"	EP(3/N)()6041(K/N)	\$877	\$1,597	\$1,997	\$2,197	\$2,396	+\$25	+\$50

49" H

12"	EP(3/N)()1249(K/N)	\$747	\$997	\$997	\$1,097	\$1,196	+\$25	+\$50
18"	EP(3/N)()1849(K/N)	\$757	\$1,097	\$1,097	\$1,207	\$1,316	+\$25	+\$50
24"	EP(3/N)()2449(K/N)	\$767	\$1,197	\$1,197	\$1,317	\$1,436	+\$25	+\$50
30"	EP(3/N)()3049(K/N)	\$787	\$1,297	\$1,297	\$1,427	\$1,556	+\$25	+\$50
36"	EP(3/N)()3649(K/N)	\$807	\$1,397	\$1,447	\$1,592	\$1,736	+\$25	+\$50
42"	EP(3/N)()4249(K/N)	\$827	\$1,497	\$1,647	\$1,812	\$1,976	+\$25	+\$50
48"	EP(3/N)()4849(K/N)	\$847	\$1,647	\$1,797	\$1,977	\$2,156	+\$25	+\$50
60"	EP(3/N)()6049(K/N)	\$897	\$1,747	\$2,097	\$2,307	\$2,516	+\$25	+\$50

Specify

1. Model #
2. Insert type
3. Insert color
4. Paint trim color

NOTE: Power duplexes cannot be installed on 12" W panels. Side mount receptacles available in 24" W panels and wider.

Plexiglass Finishes

- CL** . . Clear
IC . . Ice
SM . . Smoked
TR . . Translucent

Application Notes

Insert Panels are constructed with a tapered aluminum frame that is mitered in the corners. Insert panels may be ordered with plexiglass, laminate, or as an open frame for complete accessibility through the panel.

Assembly

- Included**
- Panel
 - Top cap
 - Metal raceway covers

Ordered Separately

- Posts
- Panel connectors
- Electrical components

Top Cap Styles

3 – Beveled

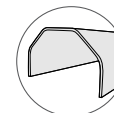

N – Flat

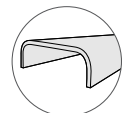

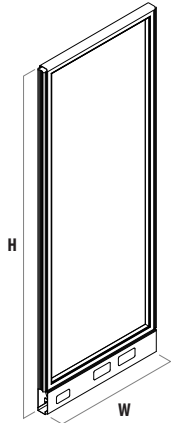

54" H

W	MODEL #	OF	PG	LAMINATE INSERT			PAINT	
				L1	L2	L3	P2	P3
12"	EP(3/N)()1254(K/N)	\$777	\$1,097	\$1,047	\$1,152	\$1,256	+ \$25	+ \$50
18"	EP(3/N)()1854(K/N)	\$787	\$1,147	\$1,147	\$1,262	\$1,376	+ \$25	+ \$50
24"	EP(3/N)()2454(K/N)	\$797	\$1,247	\$1,247	\$1,372	\$1,496	+ \$25	+ \$50
30"	EP(3/N)()3054(K/N)	\$817	\$1,347	\$1,347	\$1,482	\$1,616	+ \$25	+ \$50
36"	EP(3/N)()3654(K/N)	\$837	\$1,447	\$1,497	\$1,647	\$1,796	+ \$25	+ \$50
42"	EP(3/N)()4254(K/N)	\$857	\$1,547	\$1,697	\$1,867	\$2,036	+ \$25	+ \$50
48"	EP(3/N)()4854(K/N)	\$877	\$1,647	\$1,847	\$2,032	\$2,216	+ \$25	+ \$50
60"	EP(3/N)()6054(K/N)	\$917	\$1,797	\$2,147	\$2,362	\$2,576	+ \$25	+ \$50

61" H

12"	EP(3/N)()1261(K/N)	\$787	\$1,097	\$1,297	\$1,427	\$1,556	+ \$25	+ \$50
18"	EP(3/N)()1861(K/N)	\$797	\$1,197	\$1,447	\$1,592	\$1,736	+ \$25	+ \$50
24"	EP(3/N)()2461(K/N)	\$807	\$1,297	\$1,597	\$1,757	\$1,916	+ \$25	+ \$50
30"	EP(3/N)()3061(K/N)	\$827	\$1,397	\$1,847	\$2,032	\$2,216	+ \$25	+ \$50
36"	EP(3/N)()3661(K/N)	\$847	\$1,497	\$2,047	\$2,252	\$2,456	+ \$25	+ \$50
42"	EP(3/N)()4261(K/N)	\$867	\$1,597	\$2,297	\$2,527	\$2,756	+ \$25	+ \$50
48"	EP(3/N)()4861(K/N)	\$887	\$1,747	\$2,497	\$2,747	\$2,996	+ \$25	+ \$50
60"	EP(3/N)()6061(K/N)	\$937	\$1,927	\$2,797	\$3,077	\$3,356	+ \$25	+ \$50

64" H

12"	EP(3/N)()1264(K/N)	\$797	\$1,147	\$1,347	\$1,482	\$1,616	+ \$25	+ \$50
18"	EP(3/N)()1864(K/N)	\$807	\$1,267	\$1,547	\$1,702	\$1,856	+ \$25	+ \$50
24"	EP(3/N)()2464(K/N)	\$817	\$1,397	\$1,647	\$1,812	\$1,976	+ \$25	+ \$50
30"	EP(3/N)()3064(K/N)	\$837	\$1,497	\$1,897	\$2,087	\$2,276	+ \$25	+ \$50
36"	EP(3/N)()3664(K/N)	\$857	\$1,597	\$2,097	\$2,307	\$2,516	+ \$25	+ \$50
42"	EP(3/N)()4264(K/N)	\$877	\$1,697	\$2,347	\$2,582	\$2,816	+ \$25	+ \$50
48"	EP(3/N)()4864(K/N)	\$897	\$1,797	\$2,547	\$2,802	\$3,056	+ \$25	+ \$50
60"	EP(3/N)()6064(K/N)	\$947	\$1,997	\$2,847	\$3,132	\$3,416	+ \$25	+ \$50

81" H

12"	EP(3/N)()1264(K/N)	\$857	\$1,297	\$1,547	\$1,702	\$1,856	+ \$25	+ \$50
18"	EP(3/N)()1864(K/N)	\$867	\$1,447	\$1,797	\$1,977	\$2,156	+ \$25	+ \$50
24"	EP(3/N)()2464(K/N)	\$877	\$1,597	\$1,947	\$2,142	\$2,336	+ \$25	+ \$50
30"	EP(3/N)()3064(K/N)	\$897	\$1,747	\$2,197	\$2,417	\$2,636	+ \$25	+ \$50
36"	EP(3/N)()3664(K/N)	\$917	\$1,897	\$2,497	\$2,747	\$2,996	+ \$25	+ \$50
42"	EP(3/N)()4264(K/N)	\$937	\$2,047	\$2,747	\$3,022	\$3,296	+ \$25	+ \$50
48"	EP(3/N)()4864(K/N)	\$957	\$2,197	\$2,947	\$3,242	\$3,536	+ \$25	+ \$50
60"	EP(3/N)()6064(K/N)	\$1,027	\$2,397	\$3,247	\$3,572	\$3,896	+ \$25	+ \$50

		Top Cap	Panel Type		W	H	Raceway	
EP	Equity panel	3 Beveled N Flat	OF Open frame PG Plexiglass insert LM Laminite insert		36	29	K With knockouts N Without knockouts	
EP		N	PG		36	29	K	

Post Assemblies



Straight

H	MODEL #	PAINT		
		P1	P2	P3
29"	EP(3/N)P29S	\$148	\$155	\$162
41"	EP(3/N)P41S	\$150	\$157	\$164
49"	EP(3/N)P49S	\$152	\$159	\$166
54"	EP(3/N)P54S	\$154	\$161	\$168
61"	EP(3/N)P61S	\$156	\$163	\$170
64"	EP(3/N)P64S	\$158	\$165	\$172
81"	EP(3/N)P81S	\$175	\$182	\$189

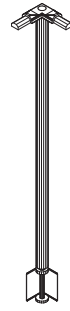

2-way L

H	MODEL #	PAINT		
		P1	P2	P3
29"	EP(3/N)P29L	\$148	\$155	\$162
41"	EP(3/N)P41L	\$150	\$157	\$164
49"	EP(3/N)P49L	\$153	\$160	\$167
54"	EP(3/N)P54L	\$157	\$164	\$171
61"	EP(3/N)P61L	\$165	\$172	\$179
64"	EP(3/N)P64L	\$172	\$179	\$186
81"	EP(3/N)P81L	\$185	\$192	\$199

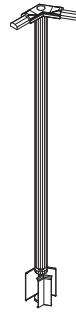

2-way 120

29"	EP(3/N)P29120	\$159	\$166	\$173
41"	EP(3/N)P41120	\$167	\$174	\$181
49"	EP(3/N)P49120	\$171	\$178	\$185
54"	EP(3/N)P54120	\$175	\$182	\$189
61"	EP(3/N)P61120	\$183	\$190	\$197
64"	EP(3/N)P64120	\$190	\$197	\$204
81"	EP(3/N)P81120	\$202	\$209	\$216

Specify

1. Model #
2. Paint trim color

Application Notes

Used to connect panels of the same height

Bottom glides on post allow for up to 1 1/2" of vertical adjustment.

Assembly

Included

- Single height post
- Panel connector
- Appropriate metal shroud

Top Cap Styles

3 – Beveled

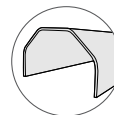

N – Flat

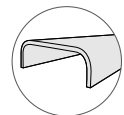

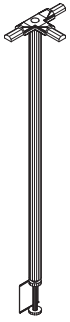

3-way T

H	MODEL #	PAINT		
		P1	P2	P3
29"	EP(3/N)P29T	\$148	\$155	\$162
41"	EP(3/N)P41T	\$150	\$157	\$164
49"	EP(3/N)P49T	\$152	\$159	\$166
54"	EP(3/N)P54T	\$154	\$161	\$168
61"	EP(3/N)P61T	\$157	\$164	\$171
64"	EP(3/N)P64T	\$164	\$171	\$178
81"	EP(3/N)P81T	\$176	\$183	\$190

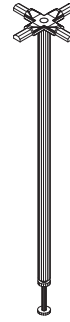

4-way X

H	MODEL #	PAINT		
		P1	P2	P3
29"	EP(3/N)P29X	\$148	\$155	\$162
41"	EP(3/N)P41X	\$150	\$157	\$164
49"	EP(3/N)P49X	\$152	\$159	\$166
54"	EP(3/N)P54X	\$154	\$161	\$168
61"	EP(3/N)P61X	\$156	\$163	\$170
64"	EP(3/N)P64X	\$158	\$165	\$172
81"	EP(3/N)P81X	\$171	\$178	\$185

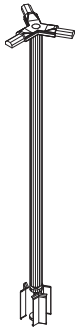

3-way 120

29"	EP(3/N)P29Y	\$179	\$188	\$197
41"	EP(3/N)P41Y	\$181	\$190	\$199
49"	EP(3/N)P49Y	\$183	\$192	\$201
54"	EP(3/N)P54Y	\$185	\$194	\$203
61"	EP(3/N)P61Y	\$187	\$196	\$205
64"	EP(3/N)P64Y	\$193	\$202	\$211
81"	EP(3/N)P81Y	\$206	\$215	\$224



Carpet Gripper

DESCRIPTION	MODEL #	BLACK ONLY
12 Pack	EP1CG12	\$38

Top Cap		H	Connection Type
EP Equity panel	3 Beveled N Flat	P Post	29 120 2-way 120 E End w/post ETK Postless end L 2-way L T 3-way T S Straight X 4-way Y 3-way 120
EP	N	P	29 S

End Kits

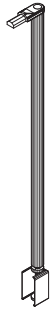

End w/Post

H	MODEL #	PAINT		
		P1	P2	P3
29"	EP(3/N)P29E	\$159	\$166	\$173
41"	EP(3/N)P41E	\$164	\$171	\$178
49"	EP(3/N)P49E	\$168	\$175	\$182
54"	EP(3/N)P54E	\$171	\$178	\$185
61"	EP(3/N)P61E	\$180	\$187	\$194
64"	EP(3/N)P64E	\$186	\$193	\$200
81"	EP(3/N)P81E	\$199	\$206	\$213



Postless End

H	MODEL #	PAINT		
		P1	P2	P3
29"	EP(3/N)ETK29	\$157	\$160	\$163
41"	EP(3/N)ETK41	\$159	\$162	\$165
49"	EP(3/N)ETK49	\$161	\$164	\$167
54"	EP(3/N)ETK54	\$163	\$166	\$169
61"	EP(3/N)ETK61	\$165	\$168	\$171
64"	EP(3/N)ETK64	\$167	\$170	\$173
81"	EP(3/N)ETK81	\$176	\$179	\$182

End w/Post

Specify

1. Model #
2. Paint trim color

Application Notes

Used to finish a panel end that is not being connected to another panel.

Assembly

Included

- Single height post
- Panel connector
- Appropriate metal shroud

Top Cap Styles

3 – Beveled

N – Flat

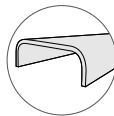
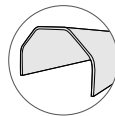

Postless End

Specify

1. Model #
2. Paint trim color

Application Notes

Used to finish a panel end that is not being connected to another panel.

NOTE: Postless end kit should not be used on panels that are placed perpendicular to a worksurface of the same depth as the front of the worksurface will extend approximately 3/4" beyond the panel end.

Assembly

Included

- Panel connector
- Appropriate metal shroud

Top Cap Styles

3 – Beveled

N – Flat

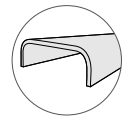
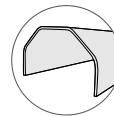



Panel Wall Starter

W	D	H	H (Actual)	MODEL #	PAINT		
					P1	P2	P3
1 1/2"	1/2"	29"	23"	EP(3/N)PWS29	\$44	\$45	\$47
1 1/2"	1/2"	41"	35"	EP(3/N)PWS41	\$44	\$45	\$47
1 1/2"	1/2"	49"	43"	EP(3/N)PWS49	\$48	\$50	\$55
1 1/2"	1/2"	54"	49"	EP(3/N)PWS54	\$50	\$55	\$59
1 1/2"	1/2"	61"	55"	EP(3/N)PWS61	\$50	\$55	\$59
1 1/2"	1/2"	64"	60"	EP(3/N)PWS64	\$52	\$56	\$62
1 1/2"	1/2"	81"	75"	EP(3/N)PWS81	\$59	\$63	\$69



Wall Mounted Channel

2 7/8"	3/4"	29"	23"	EP3WMC29	\$112	\$116	\$122
2 7/8"	3/4"	41"	35"	EP3WMC41	\$112	\$116	\$122
2 7/8"	3/4"	49"	43"	EP3WMC49	\$114	\$120	\$128
2 7/8"	3/4"	54"	49"	EP3WMC54	\$116	\$122	\$129
2 7/8"	3/4"	61"	55"	EP3WMC61	\$130	\$135	\$145
2 7/8"	3/4"	64"	60"	EP3WMC64	\$133	\$144	\$148
2 7/8"	3/4"	81"	75"	EP3WMC81	\$162	\$168	\$178
2 7/8"	3/4"	120"	120"	EP3WMC120	\$249	\$262	\$276

Panel Wall Starter

Specify

1. Model #
2. Paint trim color

Application Notes

Used to start a run of panels by fastening to an existing wall and attaching a connector assembly to it. Creates 1/4" space from face to wall to centerline of post. Constructed of steel.

NOTE: Neutral Posture assumes no responsibility for wall construction or performance of fasteners used.

Assembly

Included

- Panel top & bottom hook
- Panel connector

Not Included

- Fasteners to attach to wall

Ordered Separately

- Post
- Shrouds

Top Cap Styles

3 – Beveled

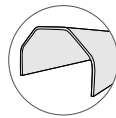

N – Flat

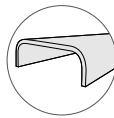

Wall Mounted Channel

Specify

1. Model #
2. Paint trim color

Application Notes

Allows hanging of all components and accessories on reinforced building walls.

Painted extruded aluminum with a plastic insert which snaps in place, covering mounting screws.

NOTE: Neutral Posture assumes no responsibility for wall construction or performance of fasteners used.

Assembly

Included

- Extruded aluminum channel
- Insert which snaps into place

Posts (Multi-Height)

Single Height

H	MODEL #	PAINT		
		P1	P2	P3
29"	EP3P29	\$93	\$96	\$99
41"	EP3P41	\$94	\$97	\$100
49"	EP3P49	\$96	\$99	\$102
54"	EP3P54	\$99	\$102	\$105
61"	EP3P61	\$105	\$108	\$111
64"	EP3P64	\$107	\$110	\$113
81"	EP3P81	\$117	\$120	\$123

Dual Height

29"/41"	EP3DP2941	\$155	\$165	\$175
29"/49"	EP3DP2949	\$165	\$175	\$185
29"/54"	EP3DP2954	\$165	\$175	\$185
29"/61"	EP3DP2961	\$175	\$185	\$195
29"/64"	EP3DP2964	\$175	\$185	\$195
29"/81"	EP3DP2981	\$195	\$205	\$215
41"/49"	EP3DP4149	\$165	\$175	\$185
41"/54"	EP3DP4154	\$165	\$175	\$185
41"/61"	EP3DP4161	\$175	\$185	\$195
41"/64"	EP3DP4164	\$175	\$185	\$195
41"/81"	EP3DP4181	\$195	\$205	\$215
49"/54"	EP3DP4954	\$165	\$175	\$185
49"/61"	EP3DP4961	\$175	\$185	\$195
49"/64"	EP3DP4964	\$175	\$185	\$195
49"/81"	EP3DP4981	\$195	\$205	\$215
54"/61"	EP3DP5461	\$175	\$185	\$195
54"/64"	EP3DP5464	\$175	\$185	\$195
54"/81"	EP3DP5481	\$195	\$205	\$215
61"/64"	EP3DP6164	\$175	\$185	\$195
61"/81"	EP3DP6181	\$195	\$205	\$215
64"/81"	EP3DP6481	\$195	\$205	\$215

Triple Height

H	MODEL #	PAINT		
		P1	P2	P3
29"/41"/49"	EP3TP294149	\$195	\$205	\$215
29"/41"/54"	EP3TP294154	\$195	\$205	\$215
29"/41"/61"	EP3TP294161	\$200	\$210	\$220
29"/41"/64"	EP3TP294164	\$200	\$210	\$220
29"/41"/81"	EP3TP294181	\$230	\$240	\$250
29"/49"/54"	EP3TP294954	\$195	\$205	\$215
29"/49"/61"	EP3TP294961	\$200	\$210	\$220
29"/49"/64"	EP3TP294964	\$200	\$210	\$220
29"/49"/81"	EP3TP294981	\$230	\$240	\$250
29"/54"/61"	EP3TP295461	\$200	\$210	\$220
29"/54"/64"	EP3TP295464	\$200	\$210	\$220
29"/54"/81"	EP3TP295481	\$230	\$240	\$250
29"/61"/64"	EP3TP296164	\$200	\$210	\$220
29"/61"/81"	EP3TP296181	\$230	\$240	\$250
29"/64"/81"	EP3TP296481	\$230	\$240	\$250
41"/49"/54"	EP3TP414954	\$195	\$205	\$215
41"/49"/61"	EP3TP414961	\$200	\$210	\$220
41"/49"/64"	EP3TP414964	\$200	\$210	\$220
41"/49"/81"	EP3TP414981	\$230	\$240	\$250
41"/54"/61"	EP3TP415461	\$200	\$210	\$220
41"/54"/64"	EP3TP415464	\$200	\$210	\$220
41"/54"/81"	EP3TP415481	\$230	\$240	\$250
41"/61"/64"	EP3TP416164	\$200	\$210	\$220
41"/61"/81"	EP3TP416181	\$230	\$240	\$250
41"/64"/81"	EP3TP416481	\$230	\$240	\$250
49"/54"/61"	EP3TP495461	\$200	\$210	\$220
49"/54"/64"	EP3TP495464	\$200	\$210	\$220
49"/54"/81"	EP3TP495481	\$230	\$240	\$250
49"/61"/64"	EP3TP496164	\$200	\$210	\$220
49"/61"/81"	EP3TP496181	\$230	\$240	\$250
49"/64"/81"	EP3TP496481	\$230	\$240	\$250
54"/61"/64"	EP3TP546164	\$200	\$210	\$220
54"/61"/81"	EP3TP546181	\$230	\$240	\$250
54"/64"/81"	EP3TP546481	\$230	\$240	\$250
61"/64"/81"	EP3TP616481	\$230	\$240	\$250

Specify

1. Model #
2. Paint trim color

Application Notes

Bottom glides on post allow for up to 1 ½" of vertical adjustment.

Specify one multi-height panel connector (EP3PCMF) for each low panel when using either a dual or triple height post in a multi-height connection.

Dual Height Posts

Used where 2 monolithic panels of 2 different heights intersect.

Triple Height Posts

Used where 3 monolithic panels of 3 different heights intersect.

Assembly

Included

- Multi-height post

Ordered Separately

- Panel Connectors
- Metal shrouds

Connectors

DESCRIPTION	MODEL #	PAINT		
		P1	P2	P3
Straight	EP(3/N)PCS	\$37	\$40	\$43
2-way L	EP(3/N)PCL	\$37	\$40	\$43
2-way 120	EP(3/N)PC120	\$37	\$40	\$43
2-way adjustable angle	EPNPACA	\$47	\$50	\$53
3-way T	EP(3/N)PCT	\$47	\$50	\$53
3-way Y 120	EP(3/N)PCY	\$47	\$50	\$53
4-way X	EP(3/N)PCX	\$47	\$50	\$53
End with post	EP(3/N)PCEP	\$37	\$40	\$43
Multi-height filler	EP(3/N)PCMF	\$37	\$40	\$43
Trim filler	EPNCTF	\$37	\$40	\$43

Metal Shrouds

DESCRIPTION	MODEL #	PAINT		
		P1	P2	P3
Straight	EP3SS	\$27	\$30	\$34
L outside	EP3SL	\$37	\$40	\$44
120 outside	EP3SO120	\$37	\$40	\$44
120 inside	EP3SI120	\$37	\$40	\$44
End w/post	EP3SEP	\$47	\$50	\$54



Straight



2-way L



2-way adjustable angle



3-way T



3-way Y 120



4-way X



End with post



Multi-height filler



Trim filler



Straight



L outside



120 outside



120 inside



End w/post

Specify

1. Model #
2. Paint trim color

Top Cap Styles

3 - Beveled

N - Flat

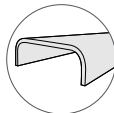
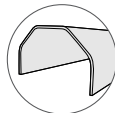

COMPONENTS

Equity stack-on panels provide the flexibility to increase the overall height of any standard Equity panel.

The stack-on panel is available in all standard Equity widths and a variety of heights in both slotted and slotless versions.

STACK-ON PANELS W/ SLOTS

Stack-on panels with slots provide the capability to hang standard Equity components such as shelves and overheads as long as the weight load does not exceed 3lbs. per lineal inch.

STACK-ON PANELS W/O SLOTS

Stack-on panels without slots do not allow for hanging components, but do provide a cleaner aesthetic when specifying window applications.

Up to two (2) load bearing stack-on panels may be stacked on top of a standard Equity panel as long as the total height above the base panels is no taller than 40" and neither individual stack-on panel is taller than 20".

Stack-on panel width must match the width of the panel it is stacking on.

Stack-on panel connectors must be used between adjacent stack-on panels.

STACK-ON PANEL CONNECTORS

STANDARD STACK-ON POST

Standard stack-on post bottom uses a conical shaped bolt that connects it to the full height post directly beneath it. Panel connectors for the top of the stack-on post must be ordered separately to match the geometry of the stack-on panels.

EXTENDED STACK-ON POST

Extended stack-on post bottom uses a double-threaded round connector to attach to the full-height post directly beneath it. Multi-height panel connectors (**EPNPCMF**) must be used on either side of this connector to provide a smooth transition for full-height post covers. Standard panel connectors are used along the top of the stack-on panels.

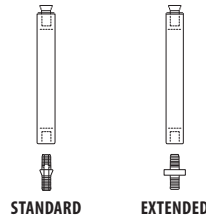

SPECIFYING STACK-ON CONFIGURATIONS

All connectors between the base panel and Stack-on Panel **MUST** have flat (N) profile.

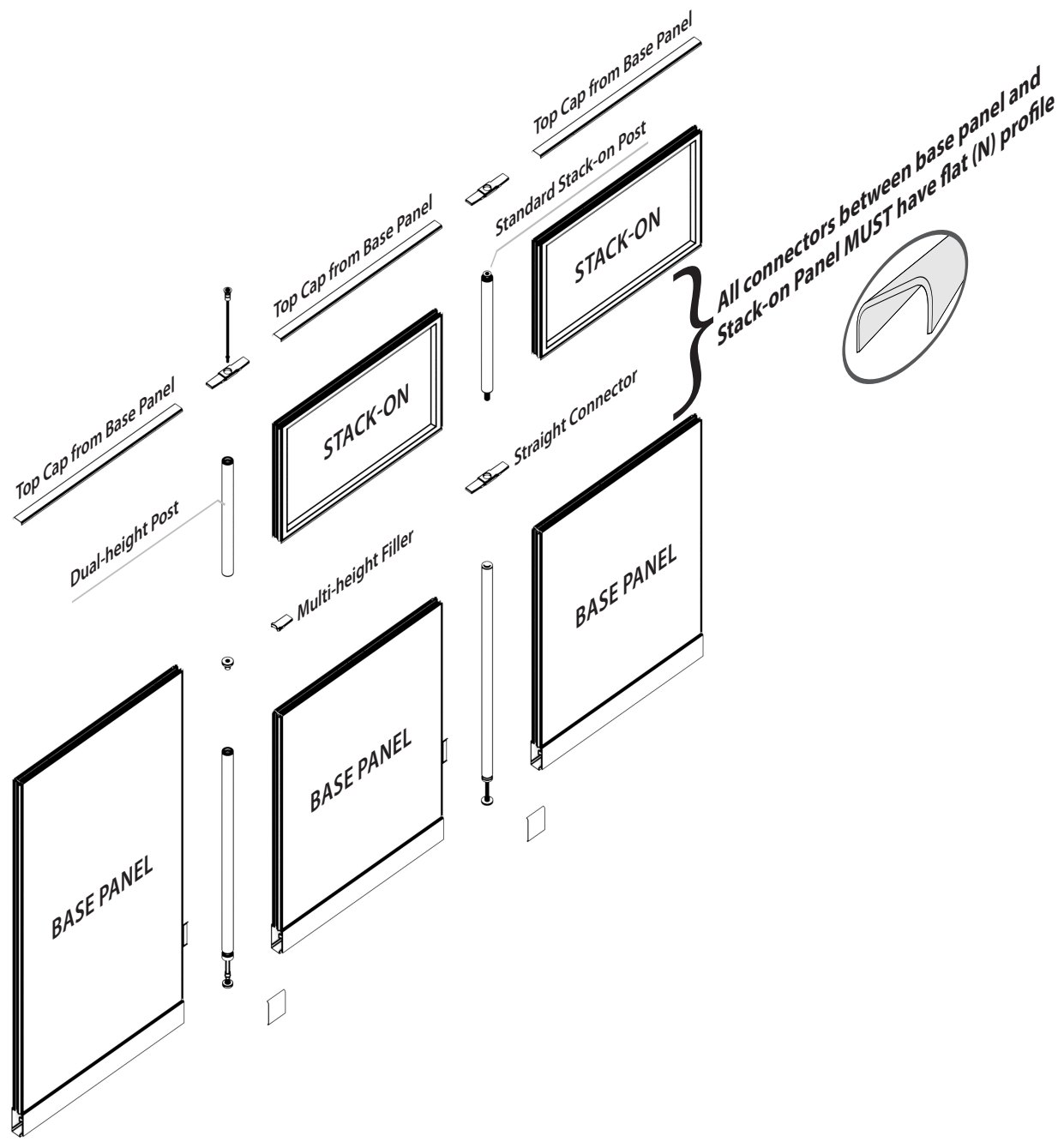

Stack-On Configurations

Using Standard Stack-on Posts

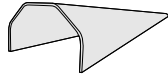
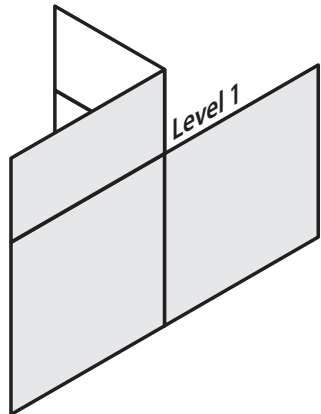
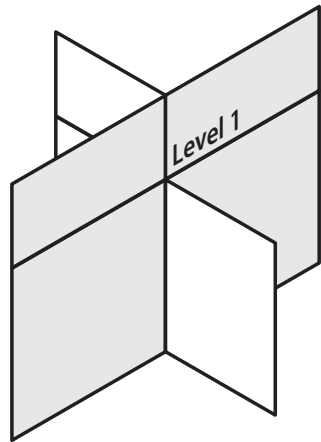
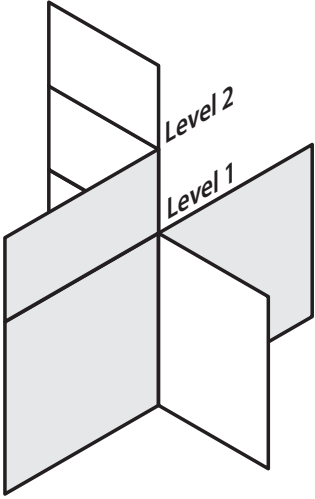

BEVELED TOP CAPS

LEVEL 1

Trim Filler
EPNCTF

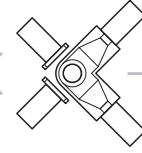

Beveled L
EP3PCL

LEVEL 2

Trim Filler
EPNCTF



Beveled End w/post
EP3PCE

LEVEL 1

Trim Filler
EPNCTF

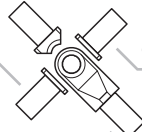

Flat Multi-height Filler
EPNCMF

Trim Filler
EPNCTF

Beveled End w/post
EP3PCE

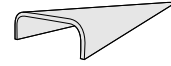

FLAT TOP CAPS

Flat X
EPNPCX

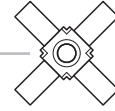

Flat X
EPNPCX



Flat X
EPNPCX

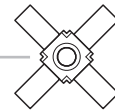

LEVEL 1

Trim Filler
EPNCTF

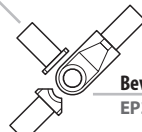

Beveled End w/post
EP3PCE

Flat Multi-height Filler
EPNCMF

Flat T
EPNPCT

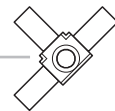

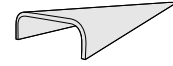
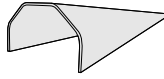

BEVELED TOP CAPS

FLAT TOP CAPS

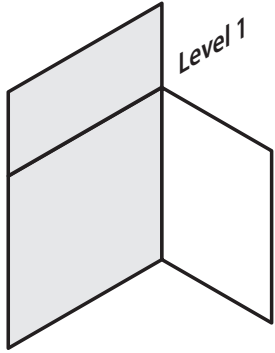

LEVEL 1

Trim Filler
EPNCTF

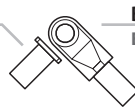

Beveled End w/post
EP3PCE

Flat L
EPNPCL

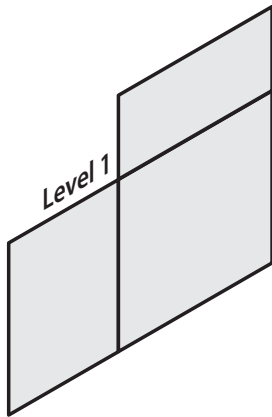

LEVEL 1

Beveled End w/post
EP3PCE

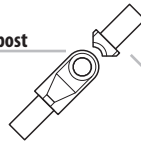

Multi-height Filler
EPNCMF

Flat Straight
EPNPSC

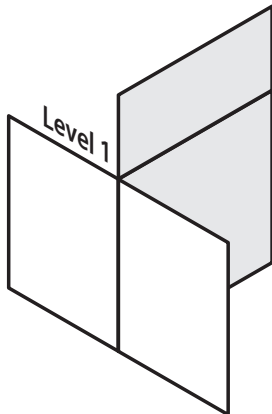
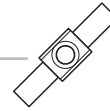

LEVEL 1

Beveled Straight
EP3PCS

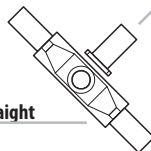

Trim Filler
EPNCTF

Flat T
EPNPCT

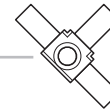

Stack-on Panels

Fabric with slots

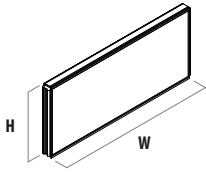

12" H

W	MODEL #	FABRIC								PAINT	
		A	B	C	D	E	F	G	H	P2	P3
12"	EP1SF1212	\$400	\$420	\$450	\$490	\$530	\$575	\$625	\$680	+ \$20	+ \$40
18"	EP1SF1812	\$420	\$440	\$470	\$510	\$550	\$595	\$645	\$700	+ \$20	+ \$40
24"	EP1SF2412	\$440	\$460	\$490	\$530	\$570	\$615	\$665	\$720	+ \$20	+ \$40
30"	EP1SF3012	\$460	\$480	\$510	\$550	\$590	\$635	\$685	\$740	+ \$20	+ \$40
36"	EP1SF3612	\$480	\$510	\$550	\$600	\$670	\$750	\$840	\$950	+ \$20	+ \$40
42"	EP1SF4212	\$500	\$530	\$570	\$620	\$690	\$770	\$860	\$970	+ \$20	+ \$40
48"	EP1SF4812	\$520	\$550	\$590	\$640	\$710	\$790	\$880	\$990	+ \$20	+ \$40
60"	EP1SF6012	\$540	\$570	\$610	\$660	\$730	\$810	\$900	\$1,010	+ \$20	+ \$40

13" H

12"	EP1SF1213	\$420	\$440	\$470	\$510	\$550	\$595	\$645	\$700	+ \$20	+ \$40
18"	EP1SF1813	\$440	\$460	\$490	\$530	\$570	\$615	\$665	\$720	+ \$20	+ \$40
24"	EP1SF2413	\$460	\$480	\$510	\$550	\$590	\$635	\$685	\$740	+ \$20	+ \$40
30"	EP1SF3013	\$480	\$520	\$570	\$630	\$700	\$790	\$890	\$1,010	+ \$20	+ \$40
36"	EP1SF3613	\$500	\$540	\$590	\$650	\$720	\$810	\$910	\$1,030	+ \$20	+ \$40
42"	EP1SF4213	\$520	\$560	\$610	\$670	\$740	\$830	\$930	\$1,050	+ \$20	+ \$40
48"	EP1SF4813	\$540	\$580	\$630	\$690	\$760	\$850	\$950	\$1,070	+ \$20	+ \$40
60"	EP1SF6013	\$560	\$600	\$650	\$710	\$780	\$870	\$970	\$1,090	+ \$20	+ \$40

15" H

12"	EP1SF1215	\$440	\$460	\$490	\$530	\$575	\$625	\$680	\$740	+ \$20	+ \$40
18"	EP1SF1815	\$460	\$480	\$510	\$550	\$595	\$645	\$700	\$760	+ \$20	+ \$40
24"	EP1SF2415	\$480	\$500	\$530	\$570	\$615	\$665	\$720	\$780	+ \$20	+ \$40
30"	EP1SF3015	\$500	\$540	\$590	\$650	\$720	\$820	\$930	\$1,050	+ \$20	+ \$40
36"	EP1SF3615	\$520	\$560	\$610	\$670	\$740	\$840	\$950	\$1,070	+ \$20	+ \$40
42"	EP1SF4215	\$540	\$580	\$630	\$690	\$760	\$860	\$970	\$1,090	+ \$20	+ \$40
48"	EP1SF4815	\$560	\$600	\$650	\$710	\$780	\$880	\$990	\$1,110	+ \$20	+ \$40
60"	EP1SF6015	\$580	\$620	\$670	\$730	\$800	\$900	\$1,010	\$1,130	+ \$20	+ \$40

Specify

1. Model #
2. Panel fabric
3. Paint trim color

Assembly

Included

- Stack-on panel
- Flat top cap (N) attached to the bottom of stack-on panel

Not Included

- Top cap
(use top cap from base panel)

Ordered Separately

- Stack-on posts
- Panel connectors

		Insert Type	W	H
EP1S	Stack-on panel	F Fabric	36	15
EP1S		F	36	15

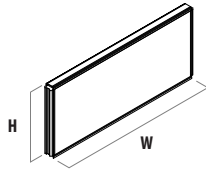

17" H

W	MODEL #	FABRIC								PAINT	
		A	B	C	D	E	F	G	H	P2	P3
12"	EP1SF1217	\$460	\$490	\$530	\$575	\$625	\$680	\$740	\$805	+ \$20	+ \$40
18"	EP1SF1817	\$480	\$510	\$550	\$595	\$645	\$700	\$760	\$825	+ \$20	+ \$40
24"	EP1SF2417	\$500	\$530	\$570	\$615	\$665	\$720	\$780	\$845	+ \$20	+ \$40
30"	EP1SF3017	\$520	\$570	\$630	\$700	\$790	\$900	\$1,020	\$1,150	+ \$20	+ \$40
36"	EP1SF3617	\$540	\$590	\$650	\$720	\$810	\$920	\$1,040	\$1,170	+ \$20	+ \$40
42"	EP1SF4217	\$560	\$610	\$670	\$740	\$830	\$940	\$1,060	\$1,190	+ \$20	+ \$40
48"	EP1SF4817	\$580	\$630	\$690	\$760	\$850	\$960	\$1,080	\$1,210	+ \$20	+ \$40
60"	EP1SF6017	\$600	\$650	\$710	\$780	\$870	\$980	\$1,100	\$1,230	+ \$20	+ \$40

20" H

12"	EP1SF1220	\$480	\$510	\$550	\$595	\$645	\$700	\$760	\$830	+ \$20	+ \$40
18"	EP1SF1820	\$500	\$530	\$570	\$615	\$665	\$720	\$780	\$850	+ \$20	+ \$40
24"	EP1SF2420	\$520	\$550	\$590	\$635	\$685	\$740	\$800	\$870	+ \$20	+ \$40
30"	EP1SF3020	\$540	\$590	\$650	\$720	\$820	\$950	\$1,090	\$1,240	+ \$20	+ \$40
36"	EP1SF3620	\$560	\$610	\$670	\$740	\$840	\$970	\$1,110	\$1,260	+ \$20	+ \$40
42"	EP1SF4220	\$580	\$630	\$690	\$760	\$860	\$990	\$1,130	\$1,280	+ \$20	+ \$40
48"	EP1SF4820	\$610	\$660	\$720	\$790	\$890	\$1,020	\$1,160	\$1,310	+ \$20	+ \$40
60"	EP1SF6020	\$630	\$680	\$740	\$810	\$910	\$1,040	\$1,180	\$1,330	+ \$20	+ \$40

Specify

1. Model #
2. Panel fabric
3. Paint trim color

Assembly

Included

- Stack-on panel
- Flat top cap (N) attached to the bottom of stack-on panel

Not Included

- Top cap
(use top cap from base panel)

Ordered Separately

- Stack-on posts
- Panel connectors

		Insert Type		W	H
EP1S	Stack-on Panel	F	Fabric	36	20
EP1S		F		36	20

Stack-on Panels

Fabric without slots

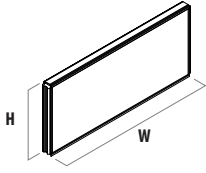

12" H

W	MODEL #	FABRIC								PAINT	
		A	B	C	D	E	F	G	H	P2	P3
12"	EP1SF1212N	\$400	\$420	\$450	\$490	\$530	\$575	\$625	\$680	+ \$20	+ \$40
18"	EP1SF1812N	\$420	\$440	\$470	\$510	\$550	\$595	\$645	\$700	+ \$20	+ \$40
24"	EP1SF2412N	\$440	\$460	\$490	\$530	\$570	\$615	\$665	\$720	+ \$20	+ \$40
30"	EP1SF3012N	\$460	\$480	\$510	\$550	\$590	\$635	\$685	\$740	+ \$20	+ \$40
36"	EP1SF3612N	\$480	\$510	\$550	\$600	\$670	\$750	\$840	\$950	+ \$20	+ \$40
42"	EP1SF4212N	\$500	\$530	\$570	\$620	\$690	\$770	\$860	\$970	+ \$20	+ \$40
48"	EP1SF4812N	\$520	\$550	\$590	\$640	\$710	\$790	\$880	\$990	+ \$20	+ \$40
60"	EP1SF6012N	\$540	\$570	\$610	\$660	\$730	\$810	\$900	\$1,010	+ \$20	+ \$40

13" H

12"	EP1SF1213N	\$420	\$440	\$470	\$510	\$550	\$595	\$645	\$700	+ \$20	+ \$40
18"	EP1SF1813N	\$440	\$460	\$490	\$530	\$570	\$615	\$665	\$720	+ \$20	+ \$40
24"	EP1SF2413N	\$460	\$480	\$510	\$550	\$590	\$635	\$685	\$740	+ \$20	+ \$40
30"	EP1SF3013N	\$480	\$520	\$570	\$630	\$700	\$790	\$890	\$1,010	+ \$20	+ \$40
36"	EP1SF3613N	\$500	\$540	\$590	\$650	\$720	\$810	\$910	\$1,030	+ \$20	+ \$40
42"	EP1SF4213N	\$520	\$560	\$610	\$670	\$740	\$830	\$930	\$1,050	+ \$20	+ \$40
48"	EP1SF4813N	\$540	\$580	\$630	\$690	\$760	\$850	\$950	\$1,070	+ \$20	+ \$40
60"	EP1SF6013N	\$560	\$600	\$650	\$710	\$780	\$870	\$970	\$1,090	+ \$20	+ \$40

15" H

12"	EP1SF1215N	\$440	\$460	\$490	\$530	\$575	\$625	\$680	\$740	+ \$20	+ \$40
18"	EP1SF1815N	\$460	\$480	\$510	\$550	\$595	\$645	\$700	\$760	+ \$20	+ \$40
24"	EP1SF2415N	\$480	\$500	\$530	\$570	\$615	\$665	\$720	\$780	+ \$20	+ \$40
30"	EP1SF3015N	\$500	\$540	\$590	\$650	\$720	\$820	\$930	\$1,050	+ \$20	+ \$40
36"	EP1SF3615N	\$520	\$560	\$610	\$670	\$740	\$840	\$950	\$1,070	+ \$20	+ \$40
42"	EP1SF4215N	\$540	\$580	\$630	\$690	\$760	\$860	\$970	\$1,090	+ \$20	+ \$40
48"	EP1SF4815N	\$560	\$600	\$650	\$710	\$780	\$880	\$990	\$1,110	+ \$20	+ \$40
60"	EP1SF6015N	\$580	\$620	\$670	\$730	\$800	\$900	\$1,010	\$1,130	+ \$20	+ \$40

17" H

12"	EP1SF1217N	\$460	\$490	\$530	\$575	\$625	\$680	\$740	\$805	+ \$20	+ \$40
18"	EP1SF1817N	\$480	\$510	\$550	\$595	\$645	\$700	\$760	\$825	+ \$20	+ \$40
24"	EP1SF2417N	\$500	\$530	\$570	\$615	\$665	\$720	\$780	\$845	+ \$20	+ \$40
30"	EP1SF3017N	\$520	\$570	\$630	\$700	\$790	\$900	\$1,020	\$1,150	+ \$20	+ \$40
36"	EP1SF3617N	\$540	\$590	\$650	\$720	\$810	\$920	\$1,040	\$1,170	+ \$20	+ \$40
42"	EP1SF4217N	\$560	\$610	\$670	\$740	\$830	\$940	\$1,060	\$1,190	+ \$20	+ \$40
48"	EP1SF4817N	\$580	\$630	\$690	\$760	\$850	\$960	\$1,080	\$1,210	+ \$20	+ \$40
60"	EP1SF6017N	\$600	\$650	\$710	\$780	\$870	\$980	\$1,100	\$1,230	+ \$20	+ \$40

Specify

1. Model #
2. Panel fabric
3. Paint trim color

Assembly

Included

- Stack-on panel
- Flat top cap (N) attached to the bottom of stack-on panel

Not Included

- Top cap
(use top cap from base panel)

Ordered Separately

- Stack-on posts
- Panel connectors

Stack-on Panels

Fabric without slots

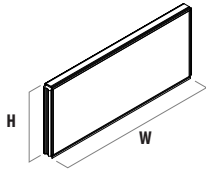

20" H

W	MODEL #	FABRIC								PAINT	
		A	B	C	D	E	F	G	H	P2	P3
12"	EP1SF1220N	\$480	\$510	\$550	\$595	\$645	\$700	\$760	\$830	+ \$20	+ \$40
18"	EP1SF1820N	\$500	\$530	\$570	\$615	\$665	\$720	\$780	\$850	+ \$20	+ \$40
24"	EP1SF2420N	\$520	\$550	\$590	\$635	\$685	\$740	\$800	\$870	+ \$20	+ \$40
30"	EP1SF3020N	\$540	\$590	\$650	\$720	\$820	\$950	\$1,090	\$1,240	+ \$20	+ \$40
36"	EP1SF3620N	\$560	\$610	\$670	\$740	\$840	\$970	\$1,110	\$1,260	+ \$20	+ \$40
42"	EP1SF4220N	\$580	\$630	\$690	\$760	\$860	\$990	\$1,130	\$1,280	+ \$20	+ \$40
48"	EP1SF4820N	\$610	\$660	\$720	\$790	\$890	\$1,020	\$1,160	\$1,310	+ \$20	+ \$40
60"	EP1SF6020N	\$630	\$680	\$740	\$810	\$910	\$1,040	\$1,180	\$1,330	+ \$20	+ \$40

25" H

12"	EP1SF1225N	\$500	\$530	\$570	\$615	\$675	\$745	\$825	\$915	+ \$20	+ \$40
18"	EP1SF1825N	\$520	\$550	\$590	\$635	\$695	\$765	\$845	\$935	+ \$20	+ \$40
24"	EP1SF2425N	\$540	\$570	\$610	\$655	\$715	\$785	\$865	\$955	+ \$20	+ \$40
30"	EP1SF3025N	\$560	\$610	\$670	\$750	\$880	\$1,030	\$1,190	\$1,360	+ \$20	+ \$40
36"	EP1SF3625N	\$580	\$630	\$690	\$770	\$900	\$1,050	\$1,210	\$1,380	+ \$20	+ \$40
42"	EP1SF4225N	\$600	\$650	\$710	\$790	\$920	\$1,070	\$1,230	\$1,400	+ \$20	+ \$40
48"	EP1SF4825N	\$630	\$680	\$740	\$820	\$950	\$1,100	\$1,260	\$1,430	+ \$20	+ \$40
60"	EP1SF6025N	\$670	\$720	\$780	\$860	\$990	\$1,140	\$1,300	\$1,470	+ \$20	+ \$40

32" H

12"	EP1SF1232N	\$520	\$550	\$590	\$635	\$695	\$785	\$885	\$995	+ \$20	+ \$40
18"	EP1SF1832N	\$540	\$570	\$610	\$655	\$715	\$805	\$905	\$1,015	+ \$20	+ \$40
24"	EP1SF2432N	\$560	\$590	\$630	\$675	\$735	\$825	\$925	\$1,035	+ \$20	+ \$40
30"	EP1SF3032N	\$580	\$630	\$690	\$780	\$930	\$1,100	\$1,290	\$1,510	+ \$20	+ \$40
36"	EP1SF3632N	\$600	\$650	\$710	\$800	\$950	\$1,120	\$1,310	\$1,530	+ \$20	+ \$40
42"	EP1SF4232N	\$620	\$670	\$730	\$820	\$970	\$1,140	\$1,330	\$1,550	+ \$20	+ \$40
48"	EP1SF4832N	\$650	\$700	\$760	\$850	\$1,000	\$1,170	\$1,360	\$1,580	+ \$20	+ \$40
60"	EP1SF6032N	\$680	\$730	\$790	\$880	\$1,030	\$1,200	\$1,390	\$1,610	+ \$20	+ \$40

37" H

12"	EP1SF1237N	\$540	\$580	\$630	\$690	\$770	\$860	\$960	\$1,070	+ \$20	+ \$40
18"	EP1SF1837N	\$560	\$600	\$650	\$710	\$790	\$880	\$980	\$1,090	+ \$20	+ \$40
24"	EP1SF2437N	\$580	\$620	\$670	\$730	\$810	\$900	\$1,000	\$1,110	+ \$20	+ \$40
30"	EP1SF3037N	\$600	\$670	\$750	\$840	\$1,000	\$1,170	\$1,370	\$1,620	+ \$20	+ \$40
36"	EP1SF3637N	\$620	\$690	\$770	\$860	\$1,020	\$1,190	\$1,390	\$1,640	+ \$20	+ \$40
42"	EP1SF4237N	\$640	\$710	\$790	\$880	\$1,040	\$1,210	\$1,410	\$1,660	+ \$20	+ \$40
48"	EP1SF4837N	\$670	\$740	\$820	\$910	\$1,070	\$1,240	\$1,440	\$1,690	+ \$20	+ \$40
60"	EP1SF6037N	\$700	\$770	\$850	\$940	\$1,100	\$1,270	\$1,470	\$1,720	+ \$20	+ \$40

		Insert Type	W	H	Slots
EP15	Stack-on panel	F Fabric	36	37	N Without slots
EP15		F	36	37	N

Stack-on Panels

Insert with slots

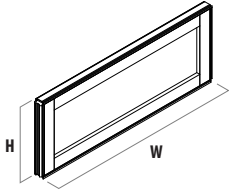

12" H

W	MODEL #	PG	LAMINATE INSERT			PAINT	
			L1	L2	L3	P2	P3
12"	EP2S()1212	\$687	\$687	\$756	\$824	+\$20	+\$40
18"	EP2S()1812	\$717	\$717	\$789	\$860	+\$20	+\$40
24"	EP2S()2412	\$747	\$747	\$822	\$896	+\$20	+\$40
30"	EP2S()3012	\$777	\$807	\$888	\$968	+\$20	+\$40
36"	EP2S()3612	\$807	\$897	\$987	\$1,076	+\$20	+\$40
42"	EP2S()4212	\$837	\$997	\$1,097	\$1,196	+\$20	+\$40
48"	EP2S()4812	\$867	\$1,057	\$1,163	\$1,268	+\$20	+\$40
60"	EP2S()6012	\$907	\$1,227	\$1,350	\$1,472	+\$20	+\$40

13" H

12"	EP2S()1213	\$727	\$727	\$800	\$872	+\$20	+\$40
18"	EP2S()1813	\$757	\$757	\$833	\$908	+\$20	+\$40
24"	EP2S()2413	\$787	\$787	\$866	\$944	+\$20	+\$40
30"	EP2S()3013	\$817	\$847	\$932	\$1,016	+\$20	+\$40
36"	EP2S()3613	\$847	\$927	\$1,020	\$1,112	+\$20	+\$40
42"	EP2S()4213	\$877	\$1,017	\$1,119	\$1,220	+\$20	+\$40
48"	EP2S()4813	\$907	\$1,097	\$1,207	\$1,316	+\$20	+\$40
60"	EP2S()6013	\$947	\$1,257	\$1,383	\$1,508	+\$20	+\$40

15"

12"	EP2S()1215	\$737	\$737	\$811	\$884	+\$20	+\$40
18"	EP2S()1815	\$767	\$767	\$844	\$920	+\$20	+\$40
24"	EP2S()2415	\$797	\$797	\$877	\$956	+\$20	+\$40
30"	EP2S()3015	\$827	\$897	\$987	\$1,076	+\$20	+\$40
36"	EP2S()3615	\$857	\$977	\$1,075	\$1,172	+\$20	+\$40
42"	EP2S()4215	\$887	\$1,077	\$1,185	\$1,292	+\$20	+\$40
48"	EP2S()4815	\$917	\$1,157	\$1,273	\$1,388	+\$20	+\$40
60"	EP2S()6015	\$957	\$1,317	\$1,449	\$1,580	+\$20	+\$40

Specify

1. Model #
2. Insert color
3. Paint trim color

Plexiglass Finishes

- CL** . . . Clear
IC . . . Ice
SM . . . Smoked
TR . . . Translucent

Assembly

- Included**
 • Stack-on panel
 • Flat top cap (N)
 attached to the bottom
 of stack-on panel

Not Included

- Top cap
*(use top cap from
 base panel)*

Ordered Separately

- Stack-on posts
- Panel connectors

Stack-on Panels

Insert with slots

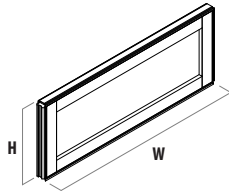

17" H

W	MODEL #	PG	LAMINATE INSERT			PAINT	
			L1	L2	L3	P2	P3
12"	EP2S()1217	\$747	\$747	\$822	\$896	+\$20	+\$40
18"	EP2S()1817	\$777	\$777	\$855	\$932	+\$20	+\$40
24"	EP2S()2417	\$807	\$837	\$921	\$1,004	+\$20	+\$40
30"	EP2S()3017	\$837	\$937	\$1,031	\$1,124	+\$20	+\$40
36"	EP2S()3617	\$867	\$1,017	\$1,119	\$1,220	+\$20	+\$40
42"	EP2S()4217	\$897	\$1,117	\$1,229	\$1,340	+\$20	+\$40
48"	EP2S()4817	\$937	\$1,197	\$1,317	\$1,436	+\$20	+\$40
60"	EP2S()6017	\$977	\$1,377	\$1,515	\$1,652	+\$20	+\$40

20" H

12"	EP2S()1220	\$777	\$777	\$855	\$932	+\$20	+\$40
18"	EP2S()1820	\$807	\$837	\$921	\$1,004	+\$20	+\$40
24"	EP2S()2420	\$837	\$907	\$998	\$1,088	+\$20	+\$40
30"	EP2S()3020	\$867	\$997	\$1,097	\$1,196	+\$20	+\$40
36"	EP2S()3620	\$897	\$1,097	\$1,207	\$1,316	+\$20	+\$40
42"	EP2S()4220	\$927	\$1,177	\$1,295	\$1,412	+\$20	+\$40
48"	EP2S()4820	\$957	\$1,257	\$1,383	\$1,508	+\$20	+\$40
60"	EP2S()6020	\$997	\$1,437	\$1,581	\$1,724	+\$20	+\$40

		Insert Type		W	H
EP2S	Stack-on panel	PG	Plexiglass	36	15
		LM	Laminate		
EP2S		PG		36	15

Stack-on Panels

Insert without slots

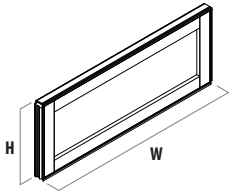

12" H

W	MODEL #	PG	LAMINATE INSERT			PAINT	
			L1	L2	L3	P2	P3
12"	EP2S()1212N	\$687	\$687	\$756	\$824	+\$20	+\$40
18"	EP2S()1812N	\$717	\$717	\$789	\$860	+\$20	+\$40
24"	EP2S()2412N	\$747	\$747	\$822	\$896	+\$20	+\$40
30"	EP2S()3012N	\$777	\$807	\$888	\$968	+\$20	+\$40
36"	EP2S()3612N	\$807	\$897	\$987	\$1,076	+\$20	+\$40
42"	EP2S()4212N	\$837	\$997	\$1,097	\$1,196	+\$20	+\$40
48"	EP2S()4812N	\$867	\$1,057	\$1,163	\$1,268	+\$20	+\$40
60"	EP2S()6012N	\$907	\$1,227	\$1,350	\$1,472	+\$20	+\$40

13" H

12"	EP2S()1213N	\$727	\$727	\$800	\$872	+\$20	+\$40
18"	EP2S()1813N	\$757	\$757	\$833	\$908	+\$20	+\$40
24"	EP2S()2413N	\$787	\$787	\$866	\$944	+\$20	+\$40
30"	EP2S()3013N	\$817	\$847	\$932	\$1,016	+\$20	+\$40
36"	EP2S()3613N	\$847	\$927	\$1,020	\$1,112	+\$20	+\$40
42"	EP2S()4213N	\$877	\$1,017	\$1,119	\$1,220	+\$20	+\$40
48"	EP2S()4813N	\$907	\$1,097	\$1,207	\$1,316	+\$20	+\$40
60"	EP2S()6013N	\$947	\$1,257	\$1,383	\$1,508	+\$20	+\$40

15" H

12"	EP2S()1215N	\$737	\$737	\$811	\$884	+\$20	+\$40
18"	EP2S()1815N	\$767	\$767	\$844	\$920	+\$20	+\$40
24"	EP2S()2415N	\$797	\$797	\$877	\$956	+\$20	+\$40
30"	EP2S()3015N	\$827	\$897	\$987	\$1,076	+\$20	+\$40
36"	EP2S()3615N	\$857	\$977	\$1,075	\$1,172	+\$20	+\$40
42"	EP2S()4215N	\$887	\$1,077	\$1,185	\$1,292	+\$20	+\$40
48"	EP2S()4815N	\$917	\$1,157	\$1,273	\$1,388	+\$20	+\$40
60"	EP2S()6015N	\$957	\$1,317	\$1,449	\$1,580	+\$20	+\$40

17" H

12"	EP2S()1217N	\$747	\$747	\$822	\$896	+\$20	+\$40
18"	EP2S()1817N	\$777	\$777	\$855	\$932	+\$20	+\$40
24"	EP2S()2417N	\$807	\$837	\$921	\$1,004	+\$20	+\$40
30"	EP2S()3017N	\$837	\$937	\$1,031	\$1,124	+\$20	+\$40
36"	EP2S()3617N	\$867	\$1,017	\$1,119	\$1,220	+\$20	+\$40
42"	EP2S()4217N	\$897	\$1,117	\$1,229	\$1,340	+\$20	+\$40
48"	EP2S()4817N	\$937	\$1,197	\$1,317	\$1,436	+\$20	+\$40
60"	EP2S()6017N	\$977	\$1,377	\$1,515	\$1,652	+\$20	+\$40

Specify

1. Model #
2. Insert color
3. Paint trim color

Plexiglass Finishes

- CL . . . Clear
 IC . . . Ice
 SM . . . Smoked
 TR . . . Translucent

Assembly

- Included**
- Stack-on panel
 - Flat top cap (N) attached to the bottom of stack-on panel

- Not Included**
- Top cap
(use top cap from base panel)

Ordered Separately

- Stack-on posts
- Panel connectors

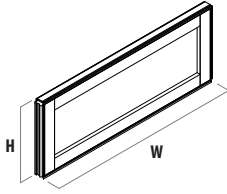

20" H

W	MODEL #	PG	LAMINATE INSERT			PAINT	
			L1	L2	L3	P2	P3
12"	EP2S()1220N	\$777	\$777	\$855	\$932	+ \$20	+ \$40
18"	EP2S()1820N	\$807	\$837	\$921	\$1,004	+ \$20	+ \$40
24"	EP2S()2420N	\$837	\$907	\$998	\$1,088	+ \$20	+ \$40
30"	EP2S()3020N	\$867	\$997	\$1,097	\$1,196	+ \$20	+ \$40
36"	EP2S()3620N	\$897	\$1,097	\$1,207	\$1,316	+ \$20	+ \$40
42"	EP2S()4220N	\$927	\$1,177	\$1,295	\$1,412	+ \$20	+ \$40
48"	EP2S()4820N	\$957	\$1,257	\$1,383	\$1,508	+ \$20	+ \$40
60"	EP2S()6020N	\$997	\$1,437	\$1,581	\$1,724	+ \$20	+ \$40

25" H

12"	EP2S()1225N	\$827	\$827	\$910	\$992	+ \$20	+ \$40
18"	EP2S()1825N	\$857	\$897	\$987	\$1,076	+ \$20	+ \$40
24"	EP2S()2425N	\$887	\$977	\$1,075	\$1,172	+ \$20	+ \$40
30"	EP2S()3025N	\$917	\$1,077	\$1,185	\$1,292	+ \$20	+ \$40
36"	EP2S()3625N	\$947	\$1,157	\$1,273	\$1,388	+ \$20	+ \$40
42"	EP2S()4225N	\$977	\$1,257	\$1,383	\$1,508	+ \$20	+ \$40
48"	EP2S()4825N	\$1,007	\$1,327	\$1,460	\$1,592	+ \$20	+ \$40
60"	EP2S()6025N	\$1,047	\$1,507	\$1,658	\$1,808	+ \$20	+ \$40

32" H

12"	EP2S()1232N	\$887	\$887	\$976	\$1,064	+ \$20	+ \$40
18"	EP2S()1832N	\$917	\$957	\$1,053	\$1,148	+ \$20	+ \$40
24"	EP2S()2432N	\$947	\$1,057	\$1,163	\$1,268	+ \$20	+ \$40
30"	EP2S()3032N	\$977	\$1,127	\$1,240	\$1,352	+ \$20	+ \$40
36"	EP2S()3632N	\$1,007	\$1,227	\$1,350	\$1,472	+ \$20	+ \$40
42"	EP2S()4232N	\$1,037	\$1,317	\$1,449	\$1,580	+ \$20	+ \$40
48"	EP2S()4832N	\$1,067	\$1,397	\$1,537	\$1,676	+ \$20	+ \$40
60"	EP2S()6032N	\$1,107	\$1,577	\$1,735	\$1,892	+ \$20	+ \$40

37" H

12"	EP2S()1237N	\$927	\$927	\$1,020	\$1,112	+ \$20	+ \$40
18"	EP2S()1837N	\$957	\$1,017	\$1,119	\$1,220	+ \$20	+ \$40
24"	EP2S()2437N	\$987	\$1,097	\$1,207	\$1,316	+ \$20	+ \$40
30"	EP2S()3037N	\$1,017	\$1,197	\$1,317	\$1,436	+ \$20	+ \$40
36"	EP2S()3637N	\$1,047	\$1,277	\$1,405	\$1,532	+ \$20	+ \$40
42"	EP2S()4237N	\$1,077	\$1,377	\$1,515	\$1,652	+ \$20	+ \$40
48"	EP2S()4837N	\$1,107	\$1,457	\$1,603	\$1,748	+ \$20	+ \$40
60"	EP2S()6037N	\$1,147	\$1,627	\$1,790	\$1,952	+ \$20	+ \$40

		Insert Type		W	H	Slots	
EP2S	Stack-on panel	PG	Plexiglass	36	37	N	Without slots
		LM	Laminate				
EP2S		PG		36	37	N	

Stack-on Posts



Standard

H	MODEL #	PAINT		
		P1	P2	P3
12"	EP1SPC12	\$125	\$130	\$135
13"	EP1SPC13	\$135	\$140	\$145
15"	EP1SPC15	\$145	\$150	\$155
17"	EP1SPC17	\$155	\$160	\$165
20"	EP1SPC20	\$175	\$185	\$195
25"	EP1SPC25	\$190	\$200	\$210
32"	EP1SPC32	\$200	\$210	\$220
37"	EP1SPC37	\$210	\$220	\$230

Panel connectors must be ordered separately.

Extended

12"	EP1SPC12E	\$125	\$130	\$135
13"	EP1SPC13E	\$135	\$140	\$145
15"	EP1SPC15E	\$145	\$150	\$155
17"	EP1SPC17E	\$155	\$160	\$165
20"	EP1SPC20E	\$175	\$185	\$195
25"	EP1SPC25E	\$190	\$200	\$210
32"	EP1SPC32E	\$200	\$210	\$220
37"	EP1SPC37E	\$210	\$220	\$230

Panel connectors must be ordered separately.

Specify

1. Model #
2. Paint trim color

Application Notes

Stack-on post must be used between adjacent stack-on panels.

Standard Stack-on

Standard stack-on post bottom uses a conical shaped bolt that connects it to the connector directly beneath it. Panel connectors for the top of the stack-on post must be ordered separately to match the geometry of the stack-on panels.

Extended Stack-on

Extended stack-on post bottom uses a double-threaded round connector to attach to the full-height post directly beneath it. Multi-height panel connectors (EPNPCMF) must be used on either side of the bottom of this connector to provide a smooth transition. Standard panel connectors are used along the top of the stack-on panels.



Coat Hook Straight

DESCRIPTION	W	D	H	MODEL #	PAINT		
					P1	P2	P3
5 Pack	1/8"	1 3/8"	2 3/8"	EP3MMCH (B/P)	\$141	N/A	N/A



Coat Hook Postless End

5 Pack	1 3/8"	3/8"	2 3/8"	EP3MMCHPE (R/L)(B/P)	\$141	N/A	N/A
--------	--------	------	--------	----------------------	-------	-----	-----

Specify

1. Model #
2. Paint trim color

Coat Hook

Aluminum coat hook attaches to any exposed Equity vertical slot. There are two versions. The straight version will work on any Equity vertical slot except for those on an inside corner. The postless end version is handed and

extends beyond the edge of a panel with a postless end. Hand is determined by which side of the panel the coat hook is installed on while facing the panel.

Available in two colors
 Black (B)
 Matte Aluminum (P)

Add-On Screens

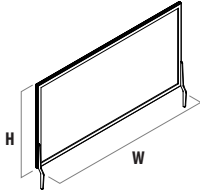

Add-on Screens

W	H	MODEL #	PAINT		
			P1	P2	P3
12"	15"	EP3AOPG1215	\$602	\$625	\$643
18"	15"	EP3AOPG1815	\$683	\$706	\$725
24"	15"	EP3AOPG2415	\$709	\$732	\$750
30"	15"	EP3AOPG3015	\$749	\$772	\$786
36"	15"	EP3AOPG3615	\$798	\$820	\$838
42"	15"	EP3AOPG4215	\$885	\$910	\$924
48"	15"	EP3AOPG4815	\$966	\$991	\$1,006
60"	15"	EP3AOPG6015	\$988	\$1,010	\$1,028

Specify

1. Model #
2. Insert color
3. Paint trim color

Plexiglass Finishes

- CL ... Clear
- IC ... Ice
- SM ... Smoked
- TR ... Translucent
- LF ... Frost

Application Notes

Add-on screens mount on the slotted standard with (2) die cast stanchion brackets that are included.

All attachment hardware is included.

Two add-on screens may not be mounted next to each other on the inside corner of a 90° connection.

Add-on screens are compatible with flat (N) and beveled (3) top caps.

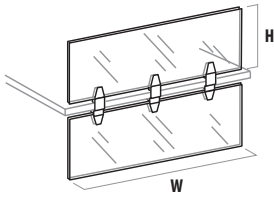

Privacy/Modesty Panels

W	H	# BRACKETS INCLUDED	MODEL #	PG	LAMINATE		
					L1	L2	L3
12"	12"	2	PRVMOD(PG/LM)12	\$337	\$297	\$327	\$356
18"	12"	2	PRVMOD(PG/LM)18	\$377	\$327	\$360	\$392
24"	12"	2	PRVMOD(PG/LM)24	\$427	\$377	\$415	\$452
30"	12"	2	PRVMOD(PG/LM)30	\$477	\$427	\$470	\$512
36"	12"	2	PRVMOD(PG/LM)36	\$527	\$477	\$525	\$572
42"	12"	2	PRVMOD(PG/LM)42	\$577	\$527	\$580	\$632
48"	12"	2	PRVMOD(PG/LM)48	\$677	\$577	\$635	\$692
60"	12"	3	PRVMOD(PG/LM)60	\$807	\$677	\$745	\$812

Specify

1. Model #
 2. Insert color
- Trim - Brushed nickel only

Plexiglass Finishes

- IC** . . . Ice
SM . . . Smoked
TR . . . Translucent
LF . . . Frost

Application Notes

Screens are ¼" thick.
 Widths are 1" less than nominal to allow for ½" set-back on each side.
 These brackets are only available in privacy & modesty sets and cannot be sold separately.

“E” Series electrical systems consist of a 4-circuit and a 6-circuit system. Each circuit in the systems provides a maximum of 20 amps. The four circuit system has eight wires; the six-circuit system has ten wires. Both 8- and 10-wire systems contain two 10-gauge “super” neutrals and two ground wires so that sensitive electronic equipment may be easily protected from unwanted electrical interference. “E” Series electrical can be connected to either single phase or three-phase building power supplies.

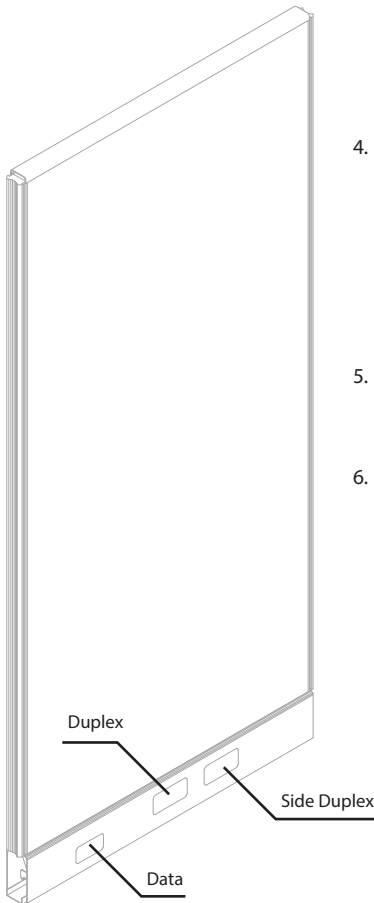

SPECIFICATION CHECKLIST

The following is a general checklist to ensure your order has been specified properly and to expedite entry of your order. It should be reviewed by a licensed electrician to ensure compliance with any local code requirements.

1. Base or ceiling infeed modules. One for each point of connection to the building power supply. Select model desired. Electrical connection to the building power supply must be made by a licensed electrician to ensure proper installation.
2. Select panels. Conduit jumpers are used to pass power to electrified panels. These panels do not have factory-installed power wiring, but modular power components are field-installed.
3. Shrouds must be used for each panel to panel point to complete the raceway connection. Shrouds are included when post assemblies are ordered. Shrouds can also be ordered separately when building a multiple height connection.
4. Duplex receptacles. Specify the circuit which receptacles are to access: #1, #2, #3 and #4D for 2+2 info eight-wire applications and additionally #5D and #6D for ten wire applications. If connecting to single-phase supply, do not order #2 and #5D receptacles.
5. Select and order appropriate conduit jumpers to pass power between panels.
6. Conduit Jumpers are for regular panel to panel connections or used to pass power through panels from terminal block to terminal block, which can be located up to 12 feet apart.

Calculate Correct Jumper Length

- 1) Add widths of both panels containing terminal blocks.
- 2) Divide by 2.
- 3) Add width of any non-electrified panels in-between. The result is the correct jumper length.

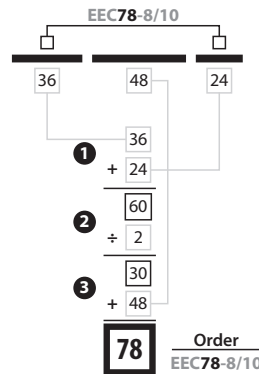

7. Modular wiring components. Internal panel wiring is fully modular and is field-installed into the raceway of panels. When wiring is field-installed the following components must be specified:

A. Terminal blocks

To branch circuits, splice jumpers or locate receptacles. Blocks snap-lock into place and are always located in the center of a panel. Panels have one block location only. Base infeed and ceiling infeed modules are each designed to plug into a terminal block, which must be ordered separately from the infeed.

B. Duplex Receptacles

Always specified separately according to circuit access.

C. Side Mount Receptacles

Available for panels 24" and wider. All standard receptacles fit into side mount position on right side of terminal block connector end. Therefore, no circuit number restriction.

SPECIAL CONSIDERATIONS

In addition to the checklist the following points should be remembered when planning a layout utilizing this electrical distribution system.

1. “E” Series electrical consists of four or six 20-amp circuits, any of which can be accessed as desired by plugging in a specially numbered receptacle at terminal block locations in panels.
2. Electrified panels can be interspersed between non-electrified panels with the use of extra-length jumpers which pass circuitry to the next electrified panel.
3. For isolation, the 2nd ground must be properly and separately grounded to the building by the installing licensed electrician.
4. Certain cities or localities carry special codes limiting the use of certain items within this system. Equity products are available which comply with these code requirements. Neutral Posture recommends contacting your local sales representative for clarification and possible restrictions.

Because of our continuous product improvements, these specifications are subject to change without notice. Please consult your sales representative for the latest information prior to ordering.

ELECTRICAL

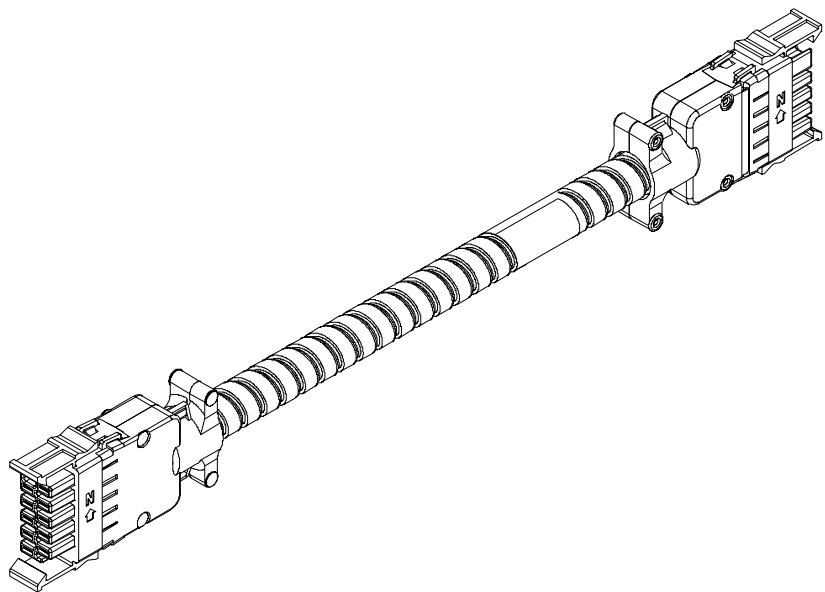

BASE INFEED MODULE

Modular base-mounted infeed conduits in eight-wire and ten-wire versions are provided for connection to building power supplies housed in underfloor outlet boxes, floor mounted (monuments) or wall outlet boxes. Available “unhanded” for ease in introducing power from left or right of infeed location. The cover plates provided by others, for floor monuments, recessed floor boxes or wall boxes are to be punched to receive a half-inch (trade size) knockout hole for installation of the box fitting, which is included on the infeed circuit. The wiring connection is to be made within the box inside the monument or behind the floor or wall flush plate. The 4' 6" conduit can be shortened to meet field conditions by cutting the infeed (loose) end. Base Infeed Module plugs into terminal block at the receptacle location. For New York and San Francisco base infeed, see page 49.

Connecting to the building power source must be performed by a licensed electrician.

CEILING INFEED MODULE

The straight tubular infeed may be shortened (on its bottom end) if it will not fit field conditions. ceiling infeed module is filled with 8- or 10- wire conduit and plugs into terminal block in adjacent panel. Harness length is 19'. Upper tube of module is 6' 7" in length.

RACEWAY PANELS WITH FIELD-INSTALLED COMPONENTRY:

1. An independent cableway with capacity for up to ten ¾" dia. communications cables.
2. A terminal block at the center of the panel allows for jumpers to connect panel to panel electrical connections and placement of duplex receptacles.
3. Terminal block allows for receptacles in two locations, one on each side of the center of the panel (back to back), into which duplex 15-amp receptacles can be placed. The raceway covers are provided with removable knockouts.
4. For increased electric demands a second duplex receptacle per panel side can be added to panels 24" and wider. This receptacle plugs directly into the right side terminal block connector ends. Any standard “E” Series receptacle may be used.
5. The faceplates on both sides of the panel are removable without removing receptacles.

The system and all standard components are UL-listed. Because of our continuous product improvements, these specifications are subject to change without notice. Please consult a Neutral Posture sales representative for the latest information prior to ordering.

CABLE CAPACITY

FILL	100%	40%
Cat 5	35	14
Cat 6	28	11

8-WIRE SYSTEM

2 + 2

The 2+2 electrical system consists of four 20 amp, 120 volt, 60-Hertz circuits. These circuits will accommodate 120 volt single phase, 120/240 volt split phase and 120/208 volt three phase power. The system components have a 20 amp capacity. The (NEC) only allows steady loads to 80% of capacity which is equivalent to 16 amps. Each circuit can generally power 8 – 10 duplex convenience outlets that are performing a normal load. However, in heavy load situations, such as computer systems each circuit will power 3 – 5 duplex outlets.

3 + 1

The 3+1 electrical system consists of four 20 amp, 120 volt, 60-Hertz circuits. These circuits will power a 120 volt single phase, a 120/240 volt split and a 120/208 volt three phase power. Each system components have the capacity to power 20 amp. The National Electric Code (NEC) only allows steady loads to 80% of capacity which is equivalent to 16 amps. Each circuit can generally power 8-10 duplex convenience outlets that are performing a normal load. However, in heavy load situations, such as computer systems each circuit will power 3 – 5 duplex outlets. If each workstation has two convenience duplex outlets and one protected duplex, the 8-wire (4-circuit) system can supply a cluster of 6 – 10 workstations from each infeed.

10-WIRE SYSTEM

3 + 3

The 3+3 electrical system consists of six 20 amp, 120 volt, 60-Hertz circuits. The circuits will accommodate 120 volt single phase, 120/240 volt split phase and 120/208 volt three phase power. Each system components have the capacity to power 20 amp. The National Electric Code (NEC) only allows steady loads to 80% of capacity which is equivalent to 16 amps. Each circuit can generally power 8 – 10 duplex convenience outlets that are performing a normal load. However, in heavy load situations, such as computer systems each circuit will power 3 – 5 duplex outlets. If each workstation has two convenience duplex outlets and one protected duplex, the 10-wire (6-circuit) system can supply a cluster of 9 – 15 workstations from each infeed.

2 + 2

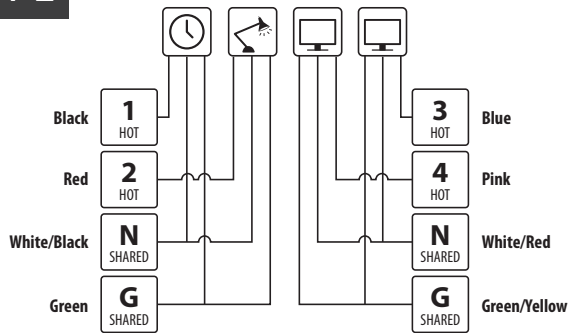

3 + 3

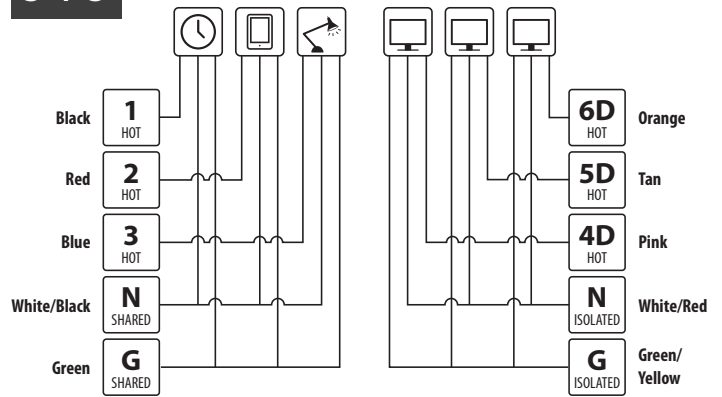

3 + 1

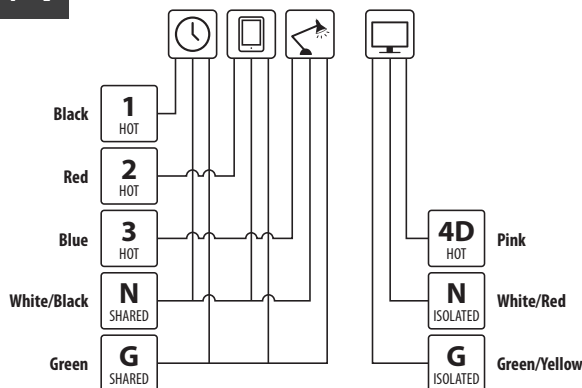

COMPATIBILITY

Equity power systems use similar components in all electrical systems. However, all parts are

not functionally interchangeable and should be used based on instructions given.



Ceiling Infeeds

W	D	H	MODEL #	PAINT		
				P1	P2	P3
4"	1 1/2"	120"	EE3CM41M	\$625	\$656	\$689
4"	1 1/2"	120"	EE3CM49M	\$625	\$656	\$689
4"	1 1/2"	120"	EE3CM54M	\$625	\$656	\$689
4"	1 1/2"	120"	EE3CM61M	\$625	\$656	\$689
4"	1 1/2"	120"	EE3CM64M	\$625	\$656	\$689
4"	1 1/2"	120"	EE3CM81M	\$625	\$656	\$689

Ceiling Infeed Harness

DESCRIPTION	MODEL #	LIST
E-Series 10-wire	EE1CH-10	\$573
E-Series 8-wire	EE1CH-8	\$470

Specify	Application Notes	Ceiling Infeed Modules		
1. Model # 2. Paint trim color Fabric cover modules are not available	To connect a metal ceiling infeed to a corner or straight connection use an adjustable angle connector or an adjustable angle connector with multi-height connector for a three-way connection.	Electrical harnesses not included with modules. Modules are hollow to accommodate power and/or data cables from source into systems furniture. With electrical harness installed, infeed holds 28 Cat 6 cables. No "hang on" capabilities. Module cannot be used for panel support.	Painted metal module is 120" long metal extrusion with attachment hooks at proper height to attach to appropriate height post. Cables/conduit are laid into module by removal of two-piece front 1 1/2" wide vertical access cover which runs the length of the extrusion. Includes escutcheon plate which is white to	integrate with ceiling. Tube is trim colored to match system trim.
Configurations				
8-wire 2 + 2 3 + 1				
10-wire 3 + 3				

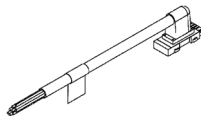

Base Infeed

DESCRIPTION	W	MODEL #	LIST
8-wire	54"	EE1BI-8	\$244
8-wire	72"	EE1BI72-8	\$301
10-wire	54"	EE1BI-10	\$295
10-wire	72"	EE1BI72-10	\$358

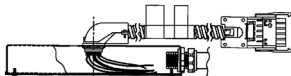

Base Infeed – New York

DESCRIPTION	MODEL #	LIST
10-wire	EE1BI-10N	\$371
8-wire	EE1BI-8N	\$304

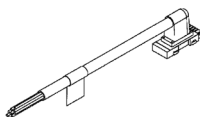

Base Infeed – San Francisco

DESCRIPTION	W	MODEL #	LIST
8-wire (non-handed)	54"	EE1BI-8SF	\$244
8-wire (non-handed)	72"	EE1BI72-8SF	\$301
10-wire (non-handed)	54"	EE1BI-10SF	\$295
10-wire (non-handed)	72"	EE1BI72-10SF	\$358

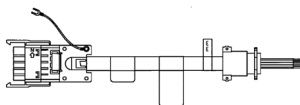

Jumper End Base Feed

DESCRIPTION	W	MODEL #	LIST
10-wire w/ground	72"	EE1BIJ-10G	\$411
8-wire w/ground	72"	EE1BIJ-8G	\$340
8-wire	72"	EE1BIJ-8	\$313
10-wire	72"	EE1BIJ-10	\$386

Configurations

- 8-wire
- 2 + 2
- 3 + 1
- 10-wire
- 3 + 3

Base Infeed Modules

An infeed conduit connects to the wall or floor outlet box of a building's power supply and plugs into a terminal block in panel raceway. Power entry can be from either left or right side of panel. Metal cover conceals the baseboard connection and is reversible for either left or right entry. Can be field-cut to proper lengths. Color is black. A terminal block must be ordered separately.

Jumper End Infeeds

Connects by hardwiring to a building's electrical supply in floor or wall box by a licensed electrician. Plugs into one set of terminal connections at end of terminal block. Terminal block must be located in panel adjacent to source. Terminal block is ordered separately. Base infeed can be field cut by a licensed electrician to necessary length. Conduit is encased in black plastic sealer.



Terminal Block

DESCRIPTION	MODEL #	8-WIRE		10-WIRE
		(3+1)	(2+2)	(3+3)
8-wire only	EE1TB(8/10)		\$56	\$72



Duplex Receptacle

DESCRIPTION	MODEL #	8-WIRE		10-WIRE
		(3+1)	(2+2)	(3+3)
Circuit #1	EE1R1	\$50	\$50	\$50
Circuit #2	EE1R2	\$50	\$50	\$50
Circuit #3 dedicated for 2+2	EE1R3D	N/A	\$50	N/A
Circuit #3 for 3+1	EE1R3	\$50	N/A	\$50
Circuit #4 dedicated circuit for 3+1, 2+2 or 3+3	EE1R4D	\$50	\$50	\$50
Circuit #5 dedicated circuit for 3+3	EE1R5D	N/A	N/A	\$50
Circuit #6 dedicated circuit for 3+3	EE1R6D	N/A	N/A	\$50



Duplex Receptacle (10 Pack)

DESCRIPTION	MODEL #	8-WIRE		10-WIRE
		(3+1)	(2+2)	(3+3)
Circuit #1	EE1R1 P10	\$411	\$411	\$411
Circuit #2	EE1R2 P10	\$411	\$411	\$411
Circuit #3 dedicated for 2+2	EE1R3D P10	N/A	\$411	N/A
Circuit #3 for 3+1	EE1R3 P10	\$411	N/A	\$411
Circuit #4 dedicated circuit for 3+1, 2+2 or 3+3	EE1R4D P10	\$411	\$411	\$411
Circuit #5 dedicated circuit for 3+3	EE1R5D P10	N/A	N/A	\$411
Circuit #6 dedicated circuit for 3+3	EE1R6D P10	N/A	N/A	\$411

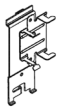

Receptacle – Side Mount

DESCRIPTION	MODEL #	8-WIRE		10-WIRE
		(3+1)	(2+2)	(3+3)
10 Pack	EE1SMRB10	\$250	\$250	\$250

Data Shield

DESCRIPTION	MODEL #	8-WIRE		10-WIRE
		(3+1)	(2+2)	(3+3)
Terminal block shield	EE15BR	\$77	\$77	\$77

Application Notes

Receptacles are black only.
Neutral wires are 10 gauge.

Terminal Block

A modular eight or ten wire block that snaps into the base location in center of the panel. Used to branch circuits, splice jumpers or locate duplex receptacles back to back.

Side Mount Receptacles

Plugs directly into the right side of terminal block to provide a second duplex receptacle where required.

Any "E" Series receptacle can be used in panels 24" wide and wider. Side mount receptacle bracket (EE1SMRB10) is needed when using a side mount receptacle.

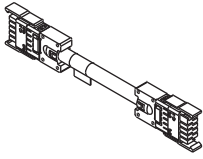

Jumper

LENGTH (NOMINAL)	LENGTH (ACTUAL)	MODEL #	8-WIRE	10-WIRE
18"	11 1/2"	EE1C18-(8/10)	\$109	\$129
21"	14 1/2"	EE1C21-(8/10)	\$113	\$132
24"	17 1/2"	EE1C24-(8/10)	\$116	\$135
27"	20 1/2"	EE1C27-(8/10)	\$117	\$144
30"	23 1/2"	EE1C30-(8/10)	\$120	\$146
33"	26 1/2"	EE1C33-(8/10)	\$123	\$152
36"	29 1/2"	EE1C36-(8/10)	\$124	\$154
39"	32 1/2"	EE1C39-(8/10)	\$130	\$161
42"	35 1/2"	EE1C42-(8/10)	\$133	\$166
45"	38 1/2"	EE1C45-(8/10)	\$136	\$168
48"	41 1/2"	EE1C48-(8/10)	\$141	\$170
51"	44 1/2"	EE1C51-(8/10)	\$146	\$178
54"	47 1/2"	EE1C54-(8/10)	\$146	\$178
57"	50 1/2"	EE1C57-(8/10)	\$154	\$185
60"	53 1/2"	EE1C60-(8/10)	\$157	\$190
63"	56 1/2"	EE1C63-(8/10)	\$162	\$193
66"	59 1/2"	EE1C66-(8/10)	\$165	\$201
69"	62 1/2"	EE1C69-(8/10)	\$165	\$201
72"	65 1/2"	EE1C72-(8/10)	\$170	\$207
75"	68 1/2"	EE1C75-(8/10)	\$172	\$210
78"	71 1/2"	EE1C78-(8/10)	\$174	\$216
81"	74 1/2"	EE1C81-(8/10)	\$177	\$217
84"	77 1/2"	EE1C84-(8/10)	\$178	\$219
87"	80 1/2"	EE1C87-(8/10)	\$186	\$229
90"	83 1/2"	EE1C90-(8/10)	\$190	\$232
93"	86 1/2"	EE1C93-(8/10)	\$192	\$235
96"	89 1/2"	EE1C96-(8/10)	\$199	\$241
99"	92 1/2"	EE1C99-(8/10)	\$202	\$244
102"	95 1/2"	EE1C102-(8/10)	\$205	\$249
105"	98 1/2"	EE1C105-(8/10)	\$207	\$253
108"	101 1/2"	EE1C108-(8/10)	\$208	\$254
111"	104 1/2"	EE1C111-(8/10)	\$216	\$259
114"	107 1/2"	EE1C114-(8/10)	\$220	\$266
120"	113 1/2"	EE1C120-(8/10)	\$230	\$278
126"	119 1/2"	EE1C126-(8/10)	\$234	\$283
132"	125 1/2"	EE1C132-(8/10)	\$238	\$292
144"	137 1/2"	EE1C144-(8/10)	\$253	\$307

Configurations

8-wire

2 + 2

3 + 1

10-wire

3 + 3

Application Notes

Jumpers transmit power circuits from one panel mounted terminal block to another. Can carry power through panels where no terminal blocks are installed. The length of the jumper corresponds to the distance between the terminal blocks.

Calculate the Correct Length

1. Add widths of both panels containing terminal blocks.
2. Divide by two.
3. Add width of any non-electrified panels in-between.

The result is the correct jumper length.

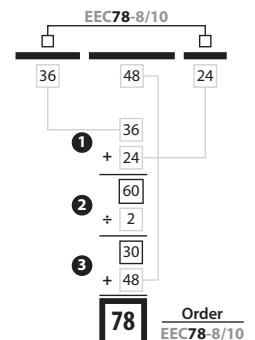



Knock-out Replacement Cover

DESCRIPTION	MODEL #	LIST
Single	EE1KC	\$15
10 Pack	EE1KC10	\$68

Specify

1. Model #
2. Paint trim color



Ashley Duo

DESCRIPTION	W	D	H	MODEL #	LIST
120" Cord length	5 1/2"	3 1/6"	2"	EE4WSAD120	\$390
72" Cord length	5 1/2"	3 1/6"	2"	EE4WSAD72	\$380



Desktop Power

108" Cord length	3 3/4"	4 1/2"		EE4WSME108	\$177
72" Cord length	3 3/4"	4 1/2"		EE4WSME72	\$157



Desktop Data

	3 3/4"	2 1/2"	5"	EE4WSMC	\$133
--	--------	--------	----	---------	-------



Desktop Power & Data

108" Cord length				EE4WSMED108	\$379
72" Cord length				EE4WSMED72	\$347

Ashley Duo

The Ashley duo features two receptacles and dual USB ports in a convenient 2 piece clamp on surface mount.

The USB charging ports provide 2.1 amps per port, 4.2 amps total. They also feature a Smart Device Recognition Chip that monitors the power request from plugged in devices, self-regulating and supplying the appropriate

amps, up to 2.1 amps, as needed by device. The result is each device receives the appropriate amount of power and charges as fast as possible.

Accommodates surfaces 1" to 1 3/4" thick.

Installation
Clamps to back of worksurface. Bracketry included.

Desktop Modules

Duplex electrical and communications outlets that attach at any point along the rear of a worksurface.

Accommodates surfaces 1" to 1 3/4" thick.

Installation
Clamps to back of worksurface with included bracketry. Available in black only.

Data Wiring

Data wiring and keystones provided by cabling contractor.

Worksurfaces

General Info

Step 1 – Model

Worksurface Type			Options						
W	D		Wiring			Extended Ends			
EW1	Rectangle	48	24	G	Grommets	\$25	E	One End	\$21
				G2	Scallop	\$50	EE	Both Ends	\$42
EW1		48	24	G			E		

Step 2 – Surface Finish

Laminate	
PW-STK	Studio Teak
PW-STK	

Step 3 – Edge Finish

Laminate	
EB-STK	Studio Teak
EB-STK	

FEATURES

DEPTHS

20" D
24" D
30" D
36" D

WIDTHS

24" W
30" W
36" W
42" W
48" W
54" W
60" W
66" W
72" W
78" W
84" W
90" W
96" W
102" W
108" W
114" W
120" W

THICKNESS

1 1/8"

WIRING & CABLING

GROMMETS

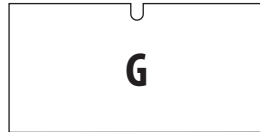

When standard grommets are specified they are in a rear, centered location and are available in black only. Corner worksurfaces provide two edge grommets.

SCALLOP



Scalloped grommets feature additional half grommets on either end to provide a full grommet when two tops meet. The half grommet also allows for cord management by itself when it is wrapped by panels and not adjacent to other worksurfaces.

CABLE DROP

3/8" cable management gap

EDGE DETAIL

STANDARD

3mm ABS

WOODGRAIN

2mm PVC

SURFACE MATERIALS

STANDARD WORKSURFACE

High Pressure Laminate

CASCADE WORKSURFACE

Thermafoil (available on Cascade edge only)

EDGEBAND

Available matching or contrasting.
Upcharge may be applicable.

SUPPORTS

Under worksurface--Black powdercoat
Countercap supports--paint

WORKSURFACES

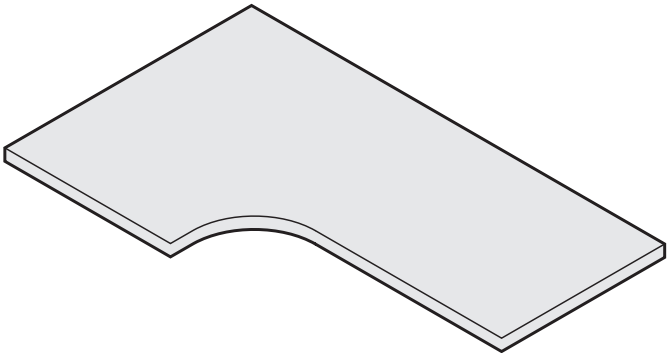

Worksurface

General Info

Top surface available in standard laminates. For a complete list of color offering consult the Finishes page at the beginning of the price list.

Underside of all 24" deep and deeper rectangular worksurfaces is predrilled for mounting of the Equity pedestals and support bracketry.

The front edge of 30" deep cantilevered surfaces should not be loaded in excess of 180 pounds.

Worksurfaces are designed to provide a 3/8" cable management gap between the back edge of the worksurface and wall panel.

D & P TOPS

Equity "D" and "P" tops are actual depth plus 1 1/2" to cover two posts and may not be panel wrapped. This allows an adjustable bar support to support the flat end without being visually obtrusive. Adjacent worksurfaces should be specified so as not to cover a post where a "D" or "P" top may be used.

EXTENDED ENDS TO COVER POSTS

Equity is measured from the center of the posts on each end of the panel. If you would like the worksurface to extend to cover one post, then you will need to add an "E". If you would like the worksurface to extend to cover both posts, then you will need to add "EE" to the worksurface item number.

- E** ... Covers 1 post
- EE** ... Covers 2 posts

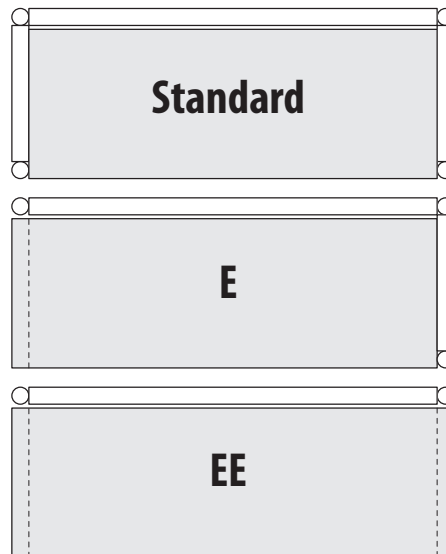

24" DEEP STRAIGHTS & 15" TOWERS

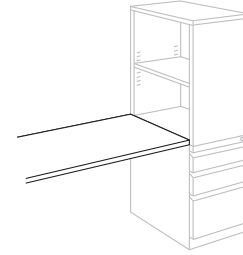

When adding a 15" tower to the end of a worksurface you will need to add a "T" to the end of the model number in order to make the worksurface and tower completely flush. This will only be necessary on 24" deep worksurfaces with a width from 48" – 84".

(T) – Available on

W	H	W (actual)	
48"	24"	43 1/4"	EW14824T
54"	24"	49 1/4"	EW15424T
60"	24"	55 1/4"	EW16024T
66"	24"	61 1/4"	EW16624T
72"	24"	67 1/4"	EW17224T
78"	24"	73 1/4"	EW17824T
84"	24"	79 1/4"	EW18424T

Worksurface Sizes		Cantilever-C		Adjustable Bar Support-S		Supporting Pedestal	Supporting Pedestal
W	D	EB1C20(L/R)		EB1SR(S/L)		24" Deep	30" Deep
24"	20"	200 lbs	2C	200 lbs	2S	N/A	N/A
24"	24"	200 lbs	2C	200 lbs	2S	+1 Support	N/A
30"	20"	200 lbs	2C	200 lbs	2S	N/A	N/A
30"	24"	200 lbs	2C	200 lbs	2S	+1 Support	N/A
30"	30"	200 lbs	2C	200 lbs	2S	—	+1 Support
36"	20"	200 lbs	2C	200 lbs	2S	N/A	N/A
36"	24"	200 lbs	2C	200 lbs	2S	+1 Support	N/A
36"	30"	200 lbs	2C	200 lbs	2S	—	+1 Support
42"	20"	200 lbs	2C	200 lbs	2S	N/A	N/A
42"	24"	200 lbs	2C	200 lbs	2S	+1 Support	N/A
42"	30"	200 lbs	2C	200 lbs	2S	—	+1 Support
48"	20"	216 lbs	2C	216 lbs	2S	N/A	N/A
48"	24"	216 lbs	2C	216 lbs	2S	+1 Support	N/A
48"	30"	216 lbs	2C	216 lbs	2S	—	+1 Support
54"	20"	243 lbs	3C	243 lbs	2S/1C	N/A	N/A
54"	24"	243 lbs	3C	243 lbs	2S/1C	+2 Support	N/A
54"	30"	243 lbs	3C	243 lbs	2S/1C	—	+2 Support
60"	20"	270 lbs	3C	270 lbs	2S/1C	N/A	N/A
60"	24"	270 lbs	3C	270 lbs	2S/1C	+2 Support	N/A
60"	30"	270 lbs	3C	270 lbs	2S/1C	—	+2 Support
66"	20"	297 lbs	3C	297 lbs	2S/1C	N/A	N/A
66"	24"	297 lbs	3C	297 lbs	2S/1C	+2 Support	N/A
66"	30"	297 lbs	3C	297 lbs	2S/1C	—	+2 Support
72"	20"	324 lbs	3C	324 lbs	2S/1C	N/A	N/A
72"	24"	324 lbs	3C	324 lbs	2S/1C	+2 Support	N/A
72"	30"	324 lbs	3C	324 lbs	2S/1C	—	+2 Support
78"	20"	351 lbs	3C	351 lbs	2S/1C	N/A	N/A
78"	24"	351 lbs	3C	351 lbs	2S/1C	+2 Support	N/A
84"	20"	378 lbs	3C	378 lbs	2S/1C	N/A	N/A
84"	24"	378 lbs	3C	378 lbs	2S/1C	+2 Support	N/A
84"	30"	—	—	378 lbs	2S/1C	—	+2 Support
90"	20"	405 lbs	3C	405 lbs	2S/1C	N/A	N/A
90"	24"	405 lbs	3C	405 lbs	2S/1C	+2 Support	N/A
96"	20"	432 lbs	3C	432 lbs	2S/1C	N/A	N/A
96"	24"	432 lbs	3C	432 lbs	2S/1C	+2 Support	N/A
96"	30"	—	—	432 lbs	2S/2C	—	+2 Support
108"	20"	486 lbs	4C	486 lbs	2S/2C	N/A	N/A
108"	24"	486 lbs	4C	486 lbs	2S/2C	+3 Support	N/A
108"	30"	—	—	486 lbs	2S/2C	—	+3 Support
120"	20"	540 lbs	4C	540 lbs	2S/2C	N/A	N/A
120"	24"	540 lbs	4C	540 lbs	2S/2C	+3 Support	N/A
120"	30"	—	—	540 lbs	2S/2C	—	+3 Support

- Support must be installed for every four feet of width. As indicated, 5' worksurfaces require three supports; two panels are required to install the center support.
- The applications shown in the table emphasize the fundamentals of worksurface loading and support. As long as these criteria are met, supports can be interchanged.
- Supporting drawer pedestals can replace only one support.
- Depth of stretched worksurfaces must be equal to or less than side panel widths.
- Stretched worksurfaces should be used where heavy loading is anticipated.
- Cantilevers cannot be used as primary support for 36" deep surfaces or 30" deep surfaces wider than 72".
- The front edge of 30" deep surfaces should not be loaded in excess of 180 pounds.

Weights listed are the Business Institutional Furniture Manufacturers Association (BIFMA) functional load requirements for panel hung worksurface loading. If loads larger than these listed are anticipated, approval from Neutral Posture is required.

INSTALLATIONS WHICH VIOLATE THESE REQUIREMENTS WILL NOT BE COVERED BY THE NEUTRAL POSTURE WARRANTY.

Rectangle

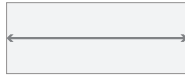

Blended Corner



Corner Round



Corner

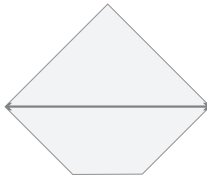
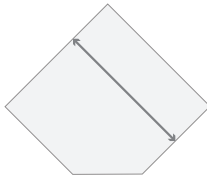
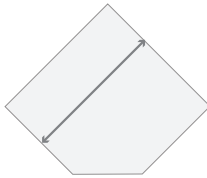

Blended Peninsula

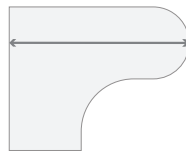

D Top



Blended Double Corner



P/9 Tops



135° Curved Cluster

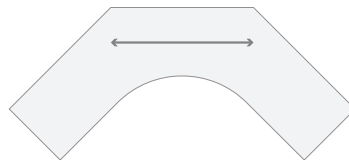

Half Round



W3

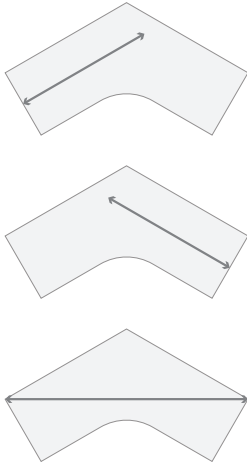

W6

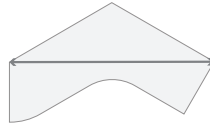

W13

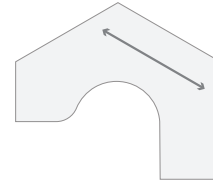

W7

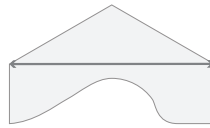

T3



W4

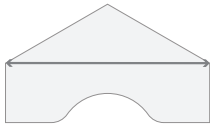

W11

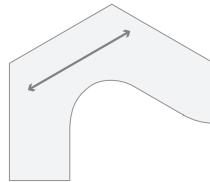

T4



W5

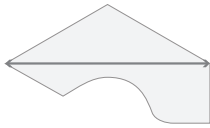

W12

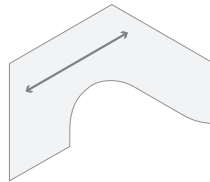

T5



Worksurfaces

Straights

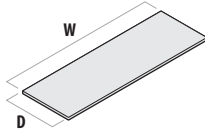

20" Deep

W	D	MODEL #	LAMINATE		
			L1	L2	L3
24"	20"	EW12420	\$310	\$341	\$372
30"	20"	EW13020	\$335	\$369	\$402
36"	20"	EW13620	\$365	\$402	\$438
42"	20"	EW14220	\$390	\$429	\$468
48"	20"	EW14820	\$420	\$462	\$504
54"	20"	EW15420	\$445	\$490	\$534
60"	20"	EW16020	\$475	\$523	\$570
66"	20"	EW16620	\$500	\$550	\$600
72"	20"	EW17220	\$510	\$561	\$612
78"	20"	EW17820	\$530	\$583	\$636
84"	20"	EW18420	\$560	\$616	\$672
90"	20"	EW19020	\$585	\$644	\$702
96"	20"	EW19620	\$615	\$677	\$738
102"	20"	EW110220	\$640	\$704	\$768
108"	20"	EW110820	\$670	\$737	\$804
114"	20"	EW111420	\$695	\$765	\$834
120"	20"	EW112020	\$725	\$798	\$870

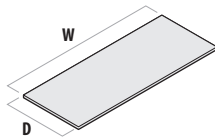

24" Deep

24"	24"	EW12424	\$340	\$374	\$408
30"	24"	EW13024	\$360	\$396	\$432
36"	24"	EW13624	\$380	\$418	\$456
42"	24"	EW14224	\$400	\$440	\$480
48"	24"	EW14824	\$420	\$462	\$504
54"	24"	EW15424	\$450	\$495	\$540
60"	24"	EW16024	\$505	\$556	\$606
66"	24"	EW16624	\$555	\$611	\$666
72"	24"	EW17224	\$565	\$622	\$678
78"	24"	EW17824	\$580	\$638	\$696
84"	24"	EW18424	\$590	\$649	\$708
90"	24"	EW19024	\$600	\$660	\$720
96"	24"	EW19624	\$635	\$699	\$762
102"	24"	EW110224	\$670	\$737	\$804
108"	24"	EW110824	\$695	\$765	\$834
114"	24"	EW111424	\$725	\$798	\$870
120"	24"	EW112024	\$750	\$825	\$900

24" DEEP STRAIGHTS & 15" TOWERS

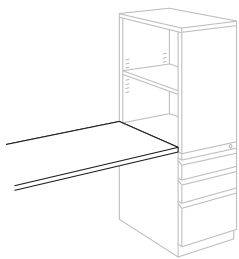

When adding a 15" tower to the end of a work surface you will need to add a "T" to the end of the model number in order to make the work surface and tower completely flush. This will only be necessary on 24" deep work surfaces with a width from 48" – 84".

Worksurface Type	W	D	Options					
			Wiring			Extended Ends		
EW1 Rectangle	48	24	G	Grommets	\$25	E	One End	\$21
			G2	Scallop	\$50	EE	Both Ends	\$42
EW1	48	24	G			E		

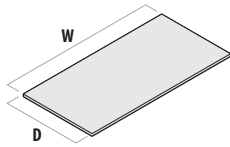

30" Deep

W	D	MODEL #	LAMINATE		
			L1	L2	L3
24"	30"	EW12430	\$390	\$429	\$468
30"	30"	EW13030	\$420	\$462	\$504
36"	30"	EW13630	\$445	\$490	\$534
42"	30"	EW14230	\$475	\$523	\$570
48"	30"	EW14830	\$490	\$539	\$588
54"	30"	EW15430	\$570	\$627	\$684
60"	30"	EW16030	\$615	\$677	\$738
66"	30"	EW16630	\$655	\$721	\$786
72"	30"	EW17230	\$690	\$759	\$828
78"	30"	EW17830	\$710	\$781	\$852
84"	30"	EW18430	\$750	\$825	\$900
90"	30"	EW19030	\$790	\$869	\$948
96"	30"	EW19630	\$815	\$897	\$978
102"	30"	EW110230	\$900	\$990	\$1,080
108"	30"	EW110830	\$945	\$1,040	\$1,134
114"	30"	EW111430	\$980	\$1,078	\$1,176
120"	30"	EW112030	\$1,020	\$1,122	\$1,224

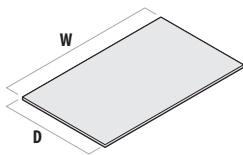

36" Deep

48"	36"	EW14836	\$680	\$748	\$816
54"	36"	EW15436	\$705	\$776	\$846
60"	36"	EW16036	\$735	\$809	\$882
66"	36"	EW16636	\$775	\$853	\$930
72"	36"	EW17236	\$830	\$913	\$996
78"	36"	EW17836	\$875	\$963	\$1,050
84"	36"	EW18436	\$900	\$990	\$1,080
90"	36"	EW19036	\$945	\$1,040	\$1,134
96"	36"	EW19636	\$1,000	\$1,100	\$1,200
102"	36"	EW110236	\$1,055	\$1,161	\$1,266
108"	36"	EW110836	\$1,115	\$1,227	\$1,338
114"	36"	EW111436	\$1,175	\$1,293	\$1,410
120"	36"	EW112036	\$1,225	\$1,348	\$1,470

Specify

1. Model #
2. Surface color
3. Edge color

Wood Grain

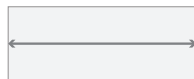

Wiring & Cabling



Grommets \$25



Scallop \$50

Support Information

All supports must be ordered separately.

Worksurface Loading & Support
See page 57

A center support must be used with a 54" wide or larger worksurface.

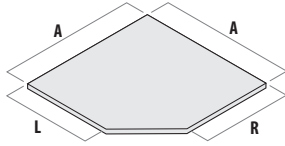

Straight Front

			LAMINATE			
A	L	R	MODEL #	L1	L2	L3
36"	20"	20"	EW1C3620	\$565	\$622	\$678
36"	24"	24"	EW1C3624	\$565	\$622	\$678
36"	30"	30"	EW1C3630	\$635	\$699	\$762
42"	20"	20"	EW1C4220	\$715	\$787	\$858
42"	24"	24"	EW1C4224	\$715	\$787	\$858
42"	30"	30"	EW1C4230	\$775	\$853	\$930
48"	20"	20"	EW1C4820	\$855	\$941	\$1,026
48"	24"	24"	EW1C4824	\$855	\$941	\$1,026
48"	30"	30"	EW1C4830	\$870	\$957	\$1,044

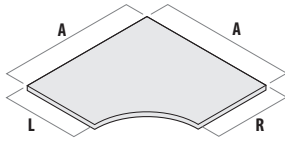

Curved Front

A	L	R	MODEL #	L1	L2	L3
36"	24"	24"	EW1CC3624	\$620	\$682	\$744
42"	24"	24"	EW1CC4224	\$790	\$869	\$948
48"	24"	24"	EW1CC4824	\$940	\$1,034	\$1,128
60"	24"	24"	EW1CC6024	\$1,050	\$1,155	\$1,260

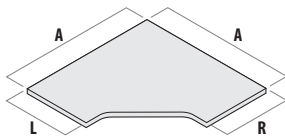

Corner with Cutout

A	L	R	MODEL #	L1	L2	L3
48"	24"	24"	EW1C4824K	\$850	\$935	\$1,020

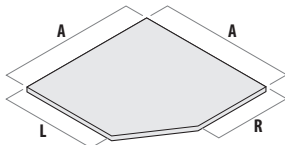

Different Returns

A	L	R	MODEL #	L1	L2	L3
36"	24"	30"	EW1C362430	\$760	\$836	\$912
36"	30"	24"	EW1C363024	\$760	\$836	\$912
42"	24"	30"	EW1C422430	\$855	\$941	\$1,026
42"	30"	24"	EW1C423024	\$855	\$941	\$1,026
48"	24"	30"	EW1C482430	\$945	\$1,040	\$1,134
48"	30"	24"	EW1C483024	\$945	\$1,040	\$1,134

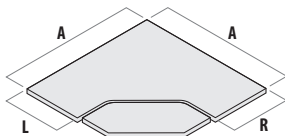

Split Corner

A	L	R	MODEL #	L1	L2	L3
36"	24"	24"	EW1SC3624	\$1,885	\$2,074	\$2,262
42"	24"	24"	EW1SC4224	\$1,935	\$2,129	\$2,322
42"	30"	30"	EW1SC4230	\$1,965	\$2,162	\$2,358
48"	24"	24"	EW1SC4824	\$2,045	\$2,250	\$2,454
48"	30"	30"	EW1SC4830	\$2,180	\$2,398	\$2,616

Specify

1. Model #
2. Options
3. Surface color
4. Edge color
5. Grain direction

Wood Grain

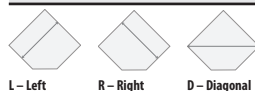

Insert the desired direction after the laminate finish code.

Add \$25 to list price for diagonal grain (D).

Wiring & Cabling

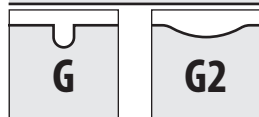

Grommets \$25 **Scalloped \$50**

Application Notes

A return panel may not be used next to corner worksurfaces, as they cover both posts for a smooth transition with adjacent rectangular worksurfaces.

Support Information

All supports must be ordered separately.

Worksurface Loading & Support
See page 57

A center support must be used with a 54" wide or larger worksurface.

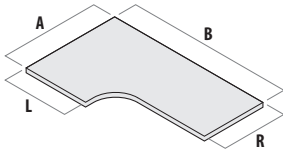

Right Hand

					LAMINATE		
L	R	A	B	MODEL #	L1	L2	L3
24"	24"	36"	60"	EW1BS3660S(X/L/R/B)	\$845	\$930	\$1,014
24"	24"	48"	60"	EW1BS4860S(X/L/R/B)	\$865	\$952	\$1,038
24"	24"	48"	66"	EW1BS4866S(X/L/R/B)	\$890	\$979	\$1,068
24"	24"	36"	72"	EW1BS3672S(X/L/R/B)	\$890	\$979	\$1,068
24"	24"	48"	72"	EW1BS4872S(X/L/R/B)	\$930	\$1,023	\$1,116
24"	30"	48"	60"	EW1BS4860D(X/L/R/B)	\$890	\$979	\$1,068
24"	30"	48"	66"	EW1BS4866D(X/L/R/B)	\$910	\$1,001	\$1,092
24"	30"	48"	72"	EW1BS4872D(X/L/R/B)	\$965	\$1,062	\$1,158
30"	24"	48"	60"	EW1BD4860S(X/L/R/B)	\$890	\$979	\$1,068
30"	24"	48"	66"	EW1BD4866S(X/L/R/B)	\$895	\$985	\$1,074
30"	24"	48"	72"	EW1BD4872S(X/L/R/B)	\$940	\$1,034	\$1,128

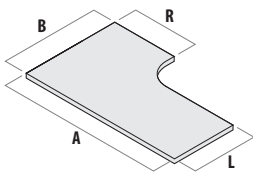

Left Hand

24"	24"	60"	36"	EW1BS6036S(X/L/R/B)	\$845	\$930	\$1,014
24"	24"	60"	48"	EW1BS6048S(X/L/R/B)	\$870	\$957	\$1,044
24"	24"	66"	48"	EW1BS6648S(X/L/R/B)	\$890	\$979	\$1,068
24"	24"	72"	36"	EW1BS7236S(X/L/R/B)	\$895	\$985	\$1,074
24"	24"	72"	48"	EW1BS7248S(X/L/R/B)	\$930	\$1,023	\$1,116
24"	30"	60"	48"	EW1BS6048D(X/L/R/B)	\$870	\$957	\$1,044
24"	30"	66"	48"	EW1BS6648D(X/L/R/B)	\$890	\$979	\$1,068
24"	30"	72"	48"	EW1BS7248D(X/L/R/B)	\$940	\$1,034	\$1,128
30"	24"	60"	48"	EW1BD6048S(X/L/R/B)	\$870	\$957	\$1,044
30"	24"	66"	48"	EW1BD6648S(X/L/R/B)	\$910	\$1,001	\$1,092
30"	24"	72"	48"	EW1BD7248S(X/L/R/B)	\$965	\$1,062	\$1,158

							Options	
		L	A	B	R	Posts Covered	Wiring	
EW1BS	Blended Worksurface	S 24" D 30"	36	72	S 24" D 30"	X No Posts Covered L Left Side Post Covered R Right Side Post Covered B Both Side Posts Covered	G Grommets \$25 G2 Scallop \$50	
EW1BS		S	36	72	S	X	G	

Specify

1. Model #
2. Options
3. Surface color
4. Edge color

Wood Grain



Wiring & Cabling

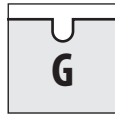

Grommets \$25



Scallop \$50

Application Notes

Blended worksurfaces are designed to take the place of two adjacent worksurfaces by blending them into one top. The front of the worksurface is curved to provide a smooth transition to the next attached worksurface.

Support Information

All supports must be ordered separately.

Worksurface Loading & Support
See page 57

A center support must be used with a 54" wide or larger worksurface.

Worksurfaces

Corner Peninsulas

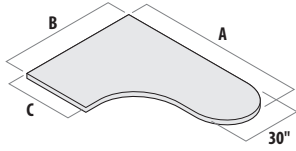

Right Hand

A	B	C	MODEL #	LAMINATE		
				L1	L2	L3
60"	48"	24"	EW1BP6048SR	\$975	\$1,073	\$1,170
72"	48"	24"	EW1BP7248SR	\$995	\$1,095	\$1,194
72"	48"	30"	EW1BP7248DR	\$1,020	\$1,122	\$1,224
78"	48"	24"	EW1BP7848SR	\$1,040	\$1,144	\$1,248
78"	48"	30"	EW1BP7848DR	\$1,040	\$1,144	\$1,248
84"	48"	24"	EW1BP8448SR	\$1,225	\$1,348	\$1,470
84"	48"	30"	EW1BP8448DR	\$1,250	\$1,375	\$1,500

Left Hand

60"	48"	24"	EW1BP6048SL	\$975	\$1,073	\$1,170
72"	48"	24"	EW1BP7248SL	\$995	\$1,095	\$1,194
72"	48"	30"	EW1BP7248DL	\$1,020	\$1,122	\$1,224
78"	48"	24"	EW1BP7848SL	\$1,040	\$1,144	\$1,248
78"	48"	30"	EW1BP7848DL	\$1,040	\$1,144	\$1,248
84"	48"	24"	EW1BP8448SL	\$1,225	\$1,348	\$1,470
84"	48"	30"	EW1BP8448DL	\$1,250	\$1,375	\$1,500

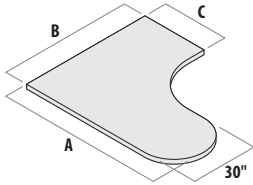

Worksurfaces

	A	B	C	Posts Covered
EW1BP Blended Peninsula	36	72	S 24" Deep D 30" Deep	X No Posts Covered L Left Side Post Covered R Right Side Post Covered B Both Side Posts Covered
EW1BP	36	72	S	X

Specify

1. Model #
2. Options
3. Surface color
4. Edge color

Wood Grain



Grommets

Blended peninsulas do not come with grommets. Due to this, if the worksurface adjacent to the "C" side is ordered with scallops there will be a one-half scallop where the return meets the peninsula.

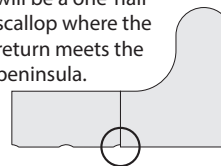

Support Information

All supports must be ordered separately.

Worksurface Loading & Support
See page 57

Center support must be used for all surfaces which exceed 48" in length.

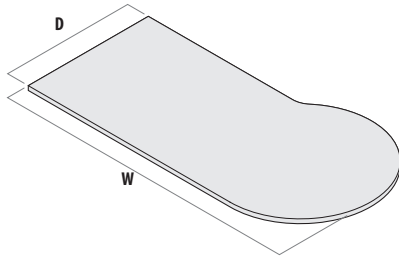
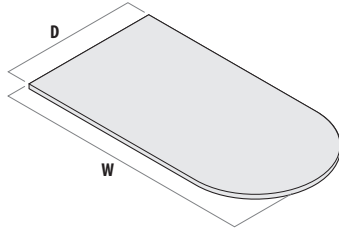

D Peninsula

W	D	MODEL #	LAMINATE		
			L1	L2	L3
60"	30"	EW1D6030	\$550	\$605	\$660
72"	30"	EW1D7230	\$955	\$1,051	\$1,146
72"	36"	EW1D7236	\$1,115	\$1,227	\$1,338
84"	30"	EW1D8430	\$1,250	\$1,375	\$1,500
84"	36"	EW1D8436	\$1,390	\$1,529	\$1,668

9 & P Peninsula

72"	30"	EW1(9/P)7230	\$955	\$1,051	\$1,146
72"	36"	EW1(9/P)7236	\$1,115	\$1,227	\$1,338
84"	30"	EW1(9/P)8430	\$1,250	\$1,375	\$1,500
84"	36"	EW1(9/P)8436	\$1,390	\$1,529	\$1,668

		W	D
EW1D	D Peninsula	72	30
EW19	9 Peninsula		
EW1P	P Peninsula		
EW1BP		72	30

Specify

1. Model #
2. Options
3. Surface color
4. Edge color

Wood Grain

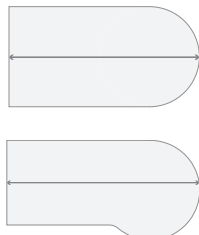

Application Notes

Designed for use as primary worksurfaces and for conferencing in small groups.

NOTE: P and D worksurfaces cannot be panel wrapped.

Support Information

Column bases and adjustable bar supports must be ordered separately. See page 68 – 69.

Worksurface Loading & Support
See page 57

84" wide D, P and 9 worksurfaces include a V support bar mounted on the underside for additional stability.

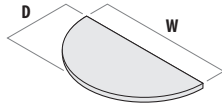

Half Round without Notch

W	D	MODEL #	LAMINATE		
			L1	L2	L3
48"	30"	EW1HR4830	\$745	\$820	\$894
60"	36"	EW1HR6036	\$934	\$1,027	\$1,121

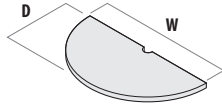

Half Round Round Notch

W	D	MODEL #	L1	L2	L3
48"	30"	EW1HR4830N	\$745	\$820	\$894
60"	36"	EW1HR6036N	\$934	\$1,027	\$1,121



Corner Round

D	MODEL #	L1	L2	L3
24"	EW1CR24	\$335	\$369	\$402
30"	EW1CR30	\$365	\$402	\$438

				Options	
		W	D	Notch	
EW1HR	Half Round	36	72	N	Round Notch
EW1HR		36	72	N	

Specify	Wood Grain	Half Round Without Notches	Half Round With Notches	Support Information
<ol style="list-style-type: none"> 1. Model # 2. Surface color 3. Edge color 		<p>Half rounds without notches attach to panels by means of an adjustable bar support and are supported by column bases, available in standard trim colors. Column is fixed height.</p>	<p>Included</p> <ul style="list-style-type: none"> • Splice plates <p>Not Included nor Required</p> <ul style="list-style-type: none"> • Bar support 	<p>All supports must be ordered separately.</p>

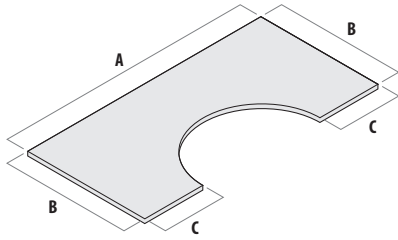

Blended Double Corner

A	B	C	MODEL #	LAMINATE		
				L1	L2	L3
96"	48"	24"	EW1BC9648	\$1,250	\$1,375	\$1,500

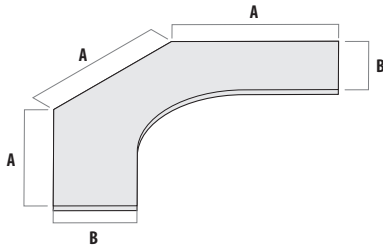

135° Curved Cluster

A	B	MODEL #	L1	L2	L3
36"	24"	EW11353624	\$917	\$1,009	\$1,100
42"	24"	EW11354224	\$1,145	\$1,260	\$1,374
48"	24"	EW11354824	\$1,317	\$1,449	\$1,580

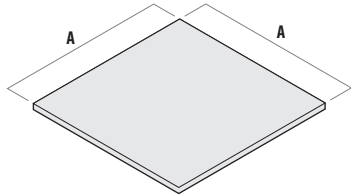

135° Cluster Core

A	MODEL #	L1	L2	L3
36"	EW1135C36	\$586	\$645	\$703
42"	EW1135C42	\$647	\$712	\$776
48"	EW1135C48	\$711	\$782	\$853

Specify

1. Model #
2. Surface color
3. Edge color

Wood Grain

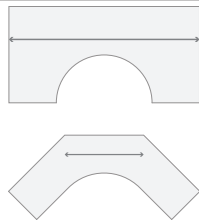

Double Corner

Double corner work surface is designed to take the place of two adjacent corners by combining them into one top.

48" deep sides are designed to cover a post and cannot be panel wrapped.

135° Curved Cluster

Used in 135° planning configurations.

Support Information

All supports must be ordered separately.

Wiring & Cabling

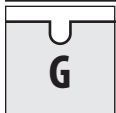

Grommets \$25



Scallop \$50

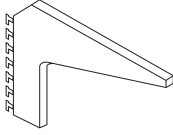

Cantilever

DESCRIPTION	D	MODEL #	BLACK ONLY
Left hand	20"	EB1C20L	\$90
Left hand (10 pack)	20"	EB1C20L10	\$700
Right hand	20"	EB1C20R	\$90
Right hand (10 pack)	20"	EB1C20R10	\$700

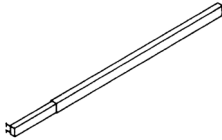

Adjustable Bar Support

DESCRIPTION	MODEL #	BLACK ONLY
24", 30" and 36"	EB1SRS	\$200
24", 30" and 36" (10 pack)	EB1SRS10	\$1,900
42", 48" and 60"	EB1SRL	\$225
42", 48" and 60" (10 pack)	EB1SRL10	\$2,000

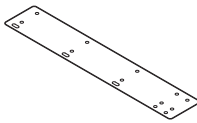

Bracket/Splice Plate

DESCRIPTION	MODEL #	BLACK ONLY
20" flat bracket (20" & 24" tops)	EB1F24	\$45
26" flat bracket (30" & 36" tops)	EB1F3	\$52
Alignment plate	EB1APW	\$14
Panel to worksurface bracket	EB1PWS(L/R)	\$15
Panel to worksurface bracket (Pair - L/R)	EB1PWSP	\$29

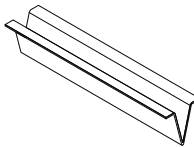

V Channel Support

DESCRIPTION	MODEL #	BLACK ONLY
54"	VS54	\$160
100"	VS100	\$300

Cantilevers

Worksurface cantilevers lock into panel slotted standards at 1" increments. Cantilevers are handed.

Available in black only.

Adjustable Bar Support

Adjustable bar supports position in the slotted standards at 1" increments. Two sizes of adjustable bar supports are available. Small adjustable bar support fits 24" through 36" wide panels; the larger adjustable bar support fits 42" through 60" wide panels. All have keyhole slots to mount worksurfaces and are non-handed.

Panel to Worksurface Bracket

Can be specified in lieu of cantilever when worksurface is same depth as adjacent panel.

A single bracket can be specified behind a pedestal to secure adjacent panel to worksurface.



Column Bases

DESCRIPTION	H	MODEL #	PAINT		
			P1	P2	P3
Fixed height support column	27 ¾"	EB1FCOL	\$320	\$348	\$362

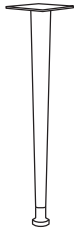

Tapered Legs

DESCRIPTION	MODEL #	P1	P2	P3
Single leg	TBTL	\$350	\$385	\$420
Single leg w/caster	TBTLC	\$375	\$410	\$445
Set of 2	TBTL2	\$600	\$660	\$720
Set of 2 w/casters	TBTL2C	\$650	\$710	\$770
Set of 4	TBTL4	\$1,150	\$1,265	\$1,380
Set of 4 w/casters	TBTL4C	\$1,250	\$1,365	\$1,480

Specify

1. Model #
2. Trim color

Worksurfaces

Panel Supported Height Adjustable

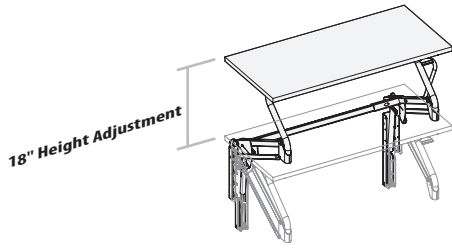

Panel Supported Height Adjustable

W	D	MODEL #	LAMINATE		
			L1	L2	L3
42"	24"	EAW14224	\$2,047	\$2,252	\$2,456
48"	24"	EAW14824	\$2,197	\$2,417	\$2,636
60"	24"	EAW16024	\$2,297	\$2,527	\$2,756
72"	24"	EAW17224	\$2,527	\$2,780	\$3,032
42"	30"	EAW14230	\$2,147	\$2,362	\$2,576
48"	30"	EAW14830	\$2,297	\$2,527	\$2,756
60"	30"	EAW16030	\$2,597	\$2,857	\$3,116
72"	30"	EAW17230	\$2,727	\$3,000	\$3,272

Worksurface Type		W	D	Options		
EAW1	Height Adjustable	42	24	Grommet		
				G	Standard	\$25
				G2	Scallop	\$50
EAW1		42	24	G		

Specify

1. Model #
2. Surface color
3. Edge color
4. Support color
Black or Silver

Wood Grain

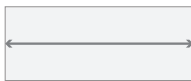

Application Notes

Provides 17" of vertical movement.

Wiring & Cabling



Grommets \$25



Scallop \$50

Specification Guidelines

1. Order an adjustable height work surface to match the panel(s) width the worksurface will be attached to. The worksurface cannot be configured to cover a partial panel.
2. There will be a 1" space around the perimeter of the adjustable height worksurface in order to prevent pinch points.
3. When used as a solitary work surface perpendicular panels of 18" minimum width must be specified on both sides for stability.
4. When used in conjunction with a stationary work surface there should be a perpendicular panel at the free end of the adjustable work surface. The free end of the fixed worksurface should be supported with a cantilever or pedestal.

NOTE: Adjustable worksurface meets BIFMA loading requirements for safety. Mechanism is designed to have up to 100 lbs. of load and function smoothly

The 120° planning model provides comparable or greater square footage per workstation than typical cubicle layouts (comparisons are illustrated on this page). At the same time, Equity 120° allows for a more natural space, creating a more comfortable place to work. Maintaining a consistent 48 module promotes improved asset management and a reduction of reconfiguration costs.



Townhouse
Sq. Feet = 34.1'
3 panels



6' x 6'
Sq. Feet = 36'
6 panels

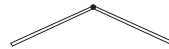

Apartment
Sq. Feet = 32.1'
2 panels



4' x 6'
Sq. Feet = 24'
4 panels

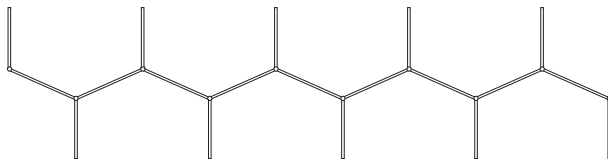

8 Open House Stations
Sq. Feet = 284'
19 panels

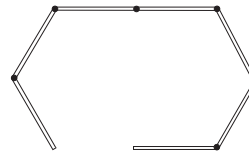

Big House
Sq. Feet = 69.8'
7 panels

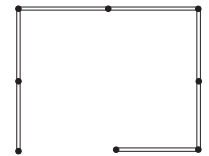

8' x 8'
Sq. Feet = 64'
7 panels

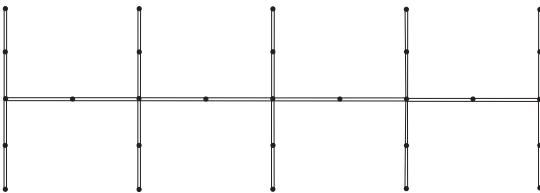

8 Station Cluster (Each station 6' x 6')
Sq. Feet = 288'
28 panels



Full House
Sq. Feet = 42.1'
5 panels

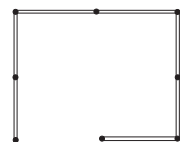

6' x 7'
Sq. Feet = 42'
7 panels

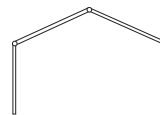

Open House
Sq. Feet = 35.5'
4 panels



6' x 6'
Sq. Feet = 36'
6 panels

Worksurfaces

120°

These worksurfaces are designed specifically for Equity 120° Applications. The (L/R) suffix at the end of a pattern number indicates a defined pedestal location. If the worksurface has no defined pedestal location, the (L/R) represents the curved side of the top. All tops and tables are available with 2mm edge band or a cascading edge.

Worksurface: W3

This worksurface, combined with the T3 transition top, works best with the "apartment" layout. This application allows for stations on both sides of the spine, and is ideal for high density layouts. Available in extended versions for placement directly next to another worksurface.

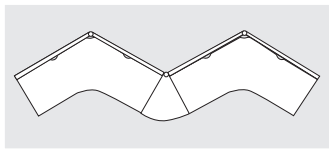

Worksurface: W4

This top works well in the "open house," "full house," and "big house" layouts for call center, professional and managerial applications.

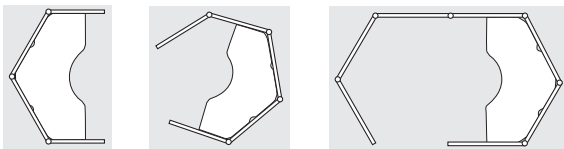

Worksurface: W5 (L/R)

With transition top T5 and this worksurface, teaming is made easy using the "townhouse" or "open house" layout. The shared space allows for call center, professional or technical applications.

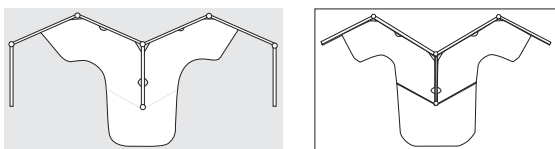

Worksurface: W6 (L/R)

In the "big house," "full house" or "open house," this worksurface allows for a pedestal on one side (determined by the L/R).

Applications for this top include a call center with the "open house," technical applications with the "full house," and managerial layouts with the "big house."

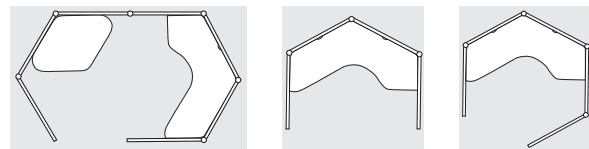

Worksurface: W7 (L/R)

Used in conjunction with a T4 transition top, the W7 worksurface provides a great teaming space when the "townhouse" layout is used. The "open house" layout incorporates the T2 transition top for professional or technical stations with shared space for conferencing. Available in extended versions for placement directly next to another worksurface.

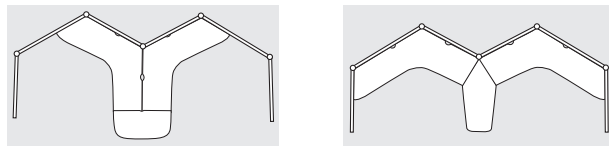

Worksurface: W11 / W1118 (L/R)

This top is a spacious option for a technical station in the "open house" layout. Adding a T2 transition top provides additional teaming space. The W11 surface also fits nicely in a private managerial office or a "full house" professional application.

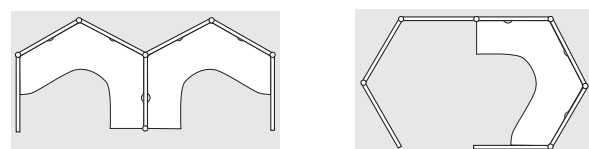

Worksurface: W12 / W1218 (L/R)

This top, with the T5/T518 transition top provides a technical office with shared conferencing space in the “open house” layout. The 18” return allows ample space in the supervisory application of the “full house.”

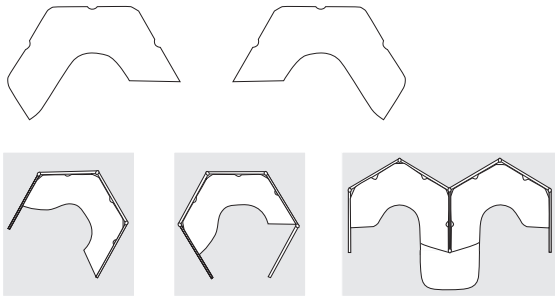

Worksurface: W13 / W1318 (L/R)

This surface provides a teaming space with the T2/T218 transition in the “open house” layout. The W13/W1318 creates generous worksurface space in the “full house” as well as the management layout of the “big house.”

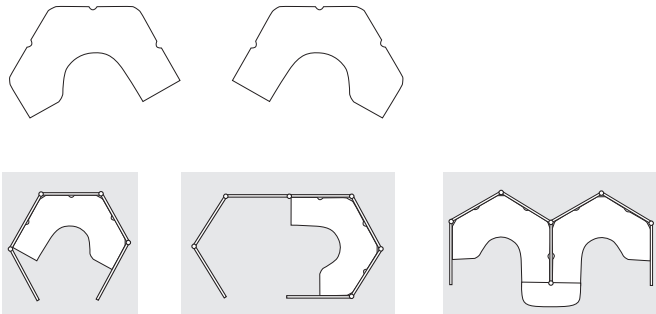

Transition Tops

Transition tops require columns (not included) for support. Flat brackets (not included) are required to attach transition tops to adjacent worksurfaces.

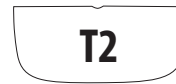

Transition top: T2



Transition top: T3



Transition top: T4



Transition top: T5

Peninsula Tops

Peninsula tops provide additional workspace in a “big house” layout.

Peninsula tops are freestanding and supported by table legs, columns or a combination of both.

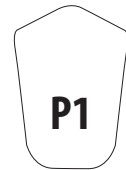

Peninsula top: P1

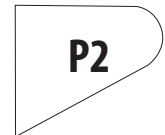

Peninsula top: P2 right hand

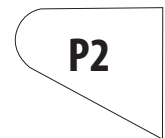

Peninsula top: P2 left hand

Worksurfaces 120°

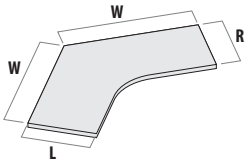

W3

W	L	R	MODEL #	LAMINATE		
				L1	L2	L3
48"	24"	24"	EW1W34824	\$1,020	\$1,122	\$1,224

Woodgrain Direction

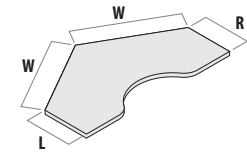

W4

48"	24"	24"	EW1W44824	\$1,030	\$1,133	\$1,236
-----	-----	-----	-----------	---------	---------	---------

Woodgrain Direction

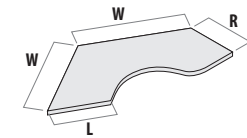

W5

48"	24"	24"	EW1W54824L	\$975	\$1,073	\$1,170
48"	24"	24"	EW1W54824R	\$975	\$1,073	\$1,170

Woodgrain Direction

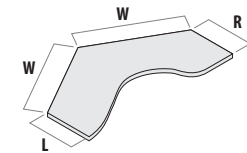

W6

48"	24"	24"	EW1W64824L	\$1,090	\$1,199	\$1,308
48"	24"	24"	EW1W64824R	\$1,090	\$1,199	\$1,308

Woodgrain Direction



Specify

1. Model #
2. Surface color
3. Edge color

Support Information

All supports must be ordered separately.

Application Notes

Refer to the worksurface planning page for worksurface drawings and applications.

W3

W3 top may be extended on either the left or right hand side by adding an "EL" or "ER" to the end of the pattern number and adding \$21.

W3 top may be extended on both ends by adding an "EB" to the end of the pattern number and adding \$42.

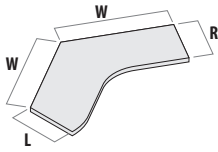

W7

W	L	R	MODEL #	LAMINATE		
				L1	L2	L3
48"	24"	24"	EW1W74824L	\$1,085	\$1,194	\$1,302
48"	24"	24"	EW1W74824R	\$1,085	\$1,194	\$1,302

Woodgrain Direction

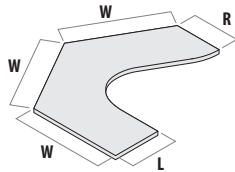
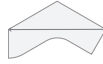

W11

48"	24"	18"	EW1W11482418	\$1,280	\$1,408	\$1,536
48"	18"	24"	EW1W11481824	\$1,280	\$1,408	\$1,536

Woodgrain Direction

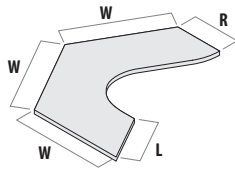

W12

48"	24"	18"	EW1W12482418	\$1,360	\$1,496	\$1,632
48"	18"	24"	EW1W12481824	\$1,360	\$1,496	\$1,632
48"	24"	24"	EW1W124824L	\$1,360	\$1,496	\$1,632
48"	24"	24"	EW1W124824R	\$1,360	\$1,496	\$1,632

Woodgrain Direction

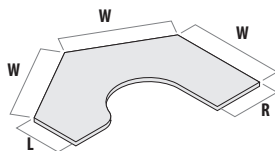

W13

48"	24"	18"	EW1W13482418	\$1,310	\$1,441	\$1,572
48"	18"	24"	EW1W13481824	\$1,310	\$1,441	\$1,572
48"	24"	24"	EW1W134824L	\$1,310	\$1,441	\$1,572
48"	24"	24"	EW1W134824R	\$1,310	\$1,441	\$1,572

Woodgrain Direction



Specify

1. Model #
2. Surface color
3. Edge color

Support Information

All supports must be ordered separately.

Application Notes

Refer to the worksurface planning page for worksurface drawings and applications.

W7

Straight ends are available extended by adding an "E" to the end of the pattern number and adding \$21.

Worksurfaces

Transition Tops

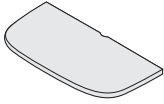

T2

W	RETURN	MODEL #	LAMINATE		
			L1	L2	L3
50"	24"	EW1T224	\$655	\$721	\$786
37 1/2"	18"	EW1T218	\$615	\$677	\$738



T3

W	RETURN	MODEL #	L1	L2	L3
26"	24"	EW1T324	\$625	\$688	\$750

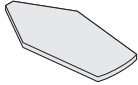

T4

W	RETURN	MODEL #	L1	L2	L3
26"	24"	EW1T424	\$645	\$710	\$774



T5

W	RETURN	MODEL #	L1	L2	L3
37 1/2"	18"	EW1T518	\$675	\$743	\$810
50"	24"	EW1T524	\$660	\$726	\$792



Peninsula Tops

W	RETURN	MODEL #	L1	L2	L3
35"	52"	EW1P15235	\$725	\$798	\$870
36"	38"	EW1P23836(L/R)	\$700	\$770	\$840

Specify

1. Model #
2. Surface color
3. Edge color

Wood Grain

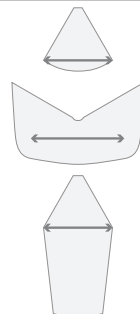

T2 Transition Top

T2 transition top comes cut to fit against a postless end. If placing against an end with a post, add an "N" to the end of the pattern number so it is notched for the post.

Support Information

Transition and peninsula tops require a column base for support.

All supports must be ordered separately.

Worksurface Loading & Support
See page 57

CASCADE EDGE



Cascade edge worksurfaces are wrapped with a thermafoil sheet that is heated and pressed around a substrate. This substrate can be FSC certified upon request. Thermafoil is more susceptible to denting, impact, tearing and marring than conventional high pressure laminate and should be handled with care. Do not drag worksurfaces across any flooring surface. Treat cascade edge worksurfaces like veneer worksurfaces for optimum performance under normal conditions. Cascade edge worksurfaces come with a 10 year warranty that covers defects in workmanship and materials. This warranty does not cover damage occurring during or after installation.

Cascade edge worksurfaces in solid colors utilize a non-PVC construction and are also free of any plasticizers, pthalates and lead content.

AVAILABLE LAMINATES

Solid

114 Folkstone Grey
117 Soft Grey
118 Bright White
119 Pumice

Woodgrain

124 Medium Cherry
125 Natural Maple
126 Natural Cherry
127 Walnut

Cascade Worksurfaces

Straights

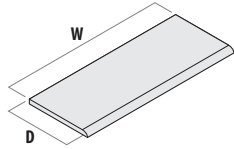

24" Deep

W	D	MODEL #	LAMINATE	
			SOLID	WOODGRAIN
24"	24"	ECE1R2424N	\$222	\$255
30"	24"	ECE1R3024N	\$255	\$293
36"	24"	ECE1R3624N	\$281	\$324
42"	24"	ECE1R4224N	\$324	\$373
48"	24"	ECE1R4824N	\$364	\$419
54"	24"	ECE1R5424N	\$391	\$449
60"	24"	ECE1R6024N	\$424	\$488
66"	24"	ECE1R6624N	\$459	\$526
72"	24"	ECE1R7224N	\$479	\$551
78"	24"	ECE1R7824N	\$515	\$591
84"	24"	ECE1R8424N	\$544	\$625
90"	24"	ECE1R9024N	\$614	\$704
96"	24"	ECE1R9624N	\$670	\$770

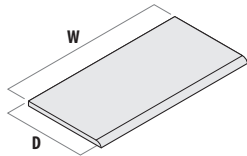

30" Deep

24"	30"	ECE1R2430N	\$282	\$326
30"	30"	ECE1R3030N	\$317	\$364
36"	30"	ECE1R3630N	\$353	\$406
42"	30"	ECE1R4230N	\$383	\$439
48"	30"	ECE1R4830N	\$424	\$488
54"	30"	ECE1R5430N	\$480	\$552
60"	30"	ECE1R6030N	\$528	\$606
66"	30"	ECE1R6630N	\$589	\$677
72"	30"	ECE1R7230N	\$614	\$704
78"	30"	ECE1R7830N	\$654	\$752
84"	30"	ECE1R8430N	\$696	\$800
90"	30"	ECE1R9030N	\$748	\$860
96"	24"	ECE1R9630N	\$800	\$919

Sample

12"	12"	ECE1R1212G2	\$137	\$159
-----	-----	-------------	-------	-------

Specify 1. Model # 2. Options 3. Surface/edge color	Wood Grain 	Wiring & Cabling Scalloped \$50	Available Laminates Solid 114 Folkstone Grey 117 Soft Grey 118 Bright White 119 Pumice Woodgrain 124 Medium Cherry 125 Natural Maple 126 Natural Cherry 127 Walnut	Support Information All supports must be ordered separately. Worksurface Loading & Support See page 57. A center support must be used with a 54" wide or larger worksurface.
Extended Ends E . . . Covers 1 post	Edge Profile 			

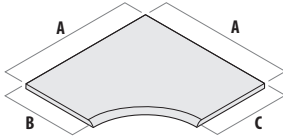

Corner – Curved Front

LAMINATE

A	B	C	MODEL #	SOLID	WOODGRAIN
36"	24"	24"	ECE1L3636SSN	\$554	\$639
42"	24"	24"	ECE1L4242SSN	\$670	\$770
42"	24"	30"	ECE1L4242SDN	\$796	\$913
42"	30"	24"	ECE1L4242DSN	\$796	\$913
48"	24"	24"	ECE1L4848SSN	\$752	\$865
48"	24"	30"	ECE1L4848SDN	\$901	\$1,036
48"	30"	24"	ECE1L4848DSN	\$901	\$1,036
48"	30"	30"	ECE1L4848DDN	\$808	\$930

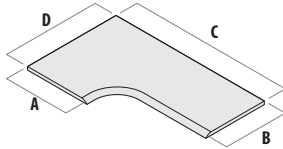

Right-Hand

A	B	C	D	MODEL #	SOLID	WOODGRAIN
24"	42"	60"	24"	ECE1L4260SS()N	\$919	\$1,058
24"	42"	66"	24"	ECE1L4266SS()N	\$943	\$1,086
24"	42"	72"	24"	ECE1L4272SS()N	\$979	\$1,127
24"	42"	78"	24"	ECE1L4278SS()N	\$991	\$1,138
24"	48"	60"	24"	ECE1L4860SS()N	\$932	\$1,070
30"	48"	60"	24"	ECE1L4860DS()N	\$913	\$1,052
24"	48"	66"	24"	ECE1L4866SS()N	\$965	\$1,109
24"	48"	66"	30"	ECE1L4866SD()N	\$961	\$1,106
30"	48"	66"	24"	ECE1L4866DS()N	\$961	\$1,106
24"	48"	72"	24"	ECE1L4872SS()N	\$1,000	\$1,150
24"	48"	72"	30"	ECE1L4872SD()N	\$1,006	\$1,158
30"	48"	72"	24"	ECE1L4872DS()N	\$1,006	\$1,158
24"	48"	78"	24"	ECE1L4878SS()N	\$1,102	\$1,268
24"	48"	84"	24"	ECE1L4884SS()N	\$1,239	\$1,426
24"	48"	84"	30"	ECE1L4860SD()N	\$913	\$1,052

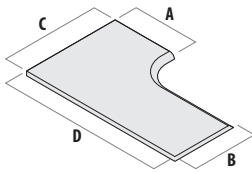

Left-Hand

24"	60"	42"	24"	ECE1L6042SS()N	\$919	\$1,058
24"	60"	48"	24"	ECE1L6048SS()N	\$932	\$1,070
24"	60"	48"	30"	ECE1L6048SD()N	\$913	\$1,052
30"	60"	48"	24"	ECE1L6048DS()N	\$913	\$1,052
24"	66"	42"	24"	ECE1L6642SS()N	\$943	\$1,086
24"	66"	48"	24"	ECE1L6648SS()N	\$965	\$1,109
24"	66"	48"	30"	ECE1L6648SD()N	\$961	\$1,106
30"	66"	48"	24"	ECE1L6648DS()N	\$961	\$1,106
24"	72"	42"	24"	ECE1L7242SS()N	\$979	\$1,127
24"	72"	48"	24"	ECE1L7248SS()N	\$1,000	\$1,150
24"	72"	48"	30"	ECE1L7248SD()N	\$1,006	\$1,158
30"	72"	48"	24"	ECE1L7248DS()N	\$1,006	\$1,158
24"	78"	42"	24"	ECE1L7842SS()N	\$991	\$1,138
24"	78"	48"	24"	ECE1L7848SS()N	\$1,102	\$1,268
24"	84"	48"	24"	ECE1L8448SS()N	\$1,239	\$1,426

Cascade Worksurfaces

Corner Peninsulas

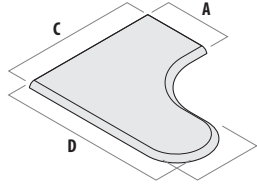
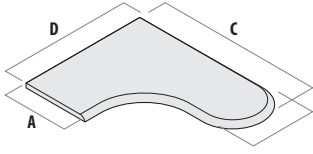

Right Handed

A	C	D	MODEL #	LAMINATE	
				SOLID	WOODGRAIN
24"	66"	48"	ECE1BD6648SR	\$898	\$1,032
30"	66"	48"	ECE1BD6648DR	\$943	\$1,086
24"	72"	48"	ECE1BD7248SR	\$917	\$1,057
30"	72"	48"	ECE1BD7248DR	\$978	\$1,125
24"	78"	48"	ECE1BD7848SR	\$1,060	\$1,219
30"	78"	48"	ECE1BD7848DR	\$1,096	\$1,259
24"	84"	48"	ECE1BD8448SR	\$1,089	\$1,252
30"	84"	48"	ECE1BD8448DR	\$1,158	\$1,330

Left Handed

A	C	D	MODEL #	LAMINATE	
				SOLID	WOODGRAIN
24"	48"	66"	ECE1BD6648SL	\$898	\$1,032
30"	48"	66"	ECE1BD6648DL	\$943	\$1,086
24"	48"	72"	ECE1BD7248SL	\$917	\$1,057
30"	48"	72"	ECE1BD7248DL	\$978	\$1,125
24"	48"	78"	ECE1BD7848SL	\$1,060	\$1,219
30"	48"	78"	ECE1BD7848DL	\$1,096	\$1,259
24"	48"	84"	ECE1BD8448SL	\$1,089	\$1,252
30"	48"	84"	ECE1BD8448DL	\$1,158	\$1,330

Specify 1. Model # 2. Options 3. Surface/edge color	Wood Grain 	Wiring & Cabling G2 Scallop \$50	Available Laminates Solid 114 Folkstone Grey 117 Soft Grey 118 Bright White 119 Pumice Woodgrain 124 Medium Cherry 125 Natural Maple 126 Natural Cherry 127 Walnut	Support Information All supports must be ordered separately.
Edge Profile 				

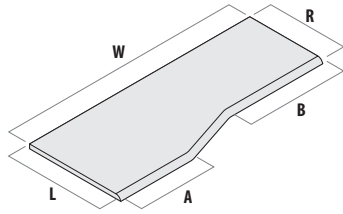

Wave End – Left Hand

W	L	R	A	B	MODEL #	LAMINATE	
						SOLID	WOODGRAIN
36"	30"	24"	15"	1 ½"	ECE1W363024N	\$596	\$685
42"	30"	24"	15"	7 ½"	ECE1W423024N	\$626	\$721
48"	30"	24"	15"	15"	ECE1W483024N	\$671	\$772
72"	30"	24"	23 ½"	30 ½"	ECE1W723024N	\$854	\$980

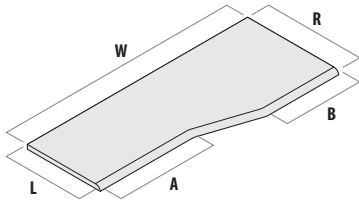

Wave End – Right Hand

W	L	R	A	B	MODEL #	SOLID	WOODGRAIN
36"	24"	30"	3"	15"	ECE1W362430N	\$596	\$685
42"	24"	30"	9"	15"	ECE1W422430N	\$626	\$721
48"	24"	30"	15"	15"	ECE1W482430N	\$671	\$772
72"	24"	30"	30 ½"	23 ½"	ECE1W722430N	\$854	\$980

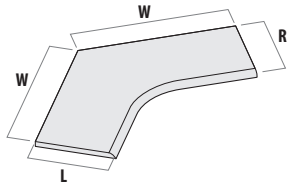

120° Worksurface

W	W	L	R	MODEL #	SOLID	WOODGRAIN
48"	48"	24"	24"	ECE1W34824G	\$979	\$1,127

Specify

1. Model #
2. Options
3. Surface/edge color

Wood Grain



Edge Profile

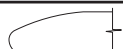

Wiring & Cabling



Scallop \$50

Available Laminates

- Solid**
- 114 Folkstone Grey
 - 117 Soft Grey
 - 118 Bright White
 - 119 Pumice

- Woodgrain**
- 124 Medium Cherry
 - 125 Natural Maple
 - 126 Natural Cherry
 - 127 Walnut

Support Information

All supports must be ordered separately.

Cascade Worksurfaces

Rounds



Half Round

W	D	MODEL #	LAMINATE	
			SOLID	WOODGRAIN
18"	48"	ECE1H4818P	\$479	\$551
48"	18"	ECE1H4818PC	\$479	\$551
48"	18"	ECE1H4818PE	\$479	\$551
60"	24"	ECE1H6024P	\$659	\$760
60"	24"	ECE1H6024PC	\$659	\$760
60"	24"	ECE1H6024PE	\$659	\$760



Corner Round

W	D	MODEL #	SOLID	WOODGRAIN
24"	24"	ECE1CR24L/R	\$255	\$293



Corner Round w/Notch

W	D	MODEL #	SOLID	WOODGRAIN
24"	24"	ECE1CR24N	\$255	\$293

Specify	Wood Grain	Wiring & Cabling	Available Laminates	Support Information
<ol style="list-style-type: none"> 1. Model # 2. Options 3. Surface/edge color 		<p>Scalloped \$50</p>	<p>Solid</p> <ul style="list-style-type: none"> 114 Folkstone Grey 117 Soft Grey 118 Bright White 119 Pumice <p>Woodgrain</p> <ul style="list-style-type: none"> 124 Medium Cherry 125 Natural Maple 126 Natural Cherry 127 Walnut 	<p>All supports must be ordered separately.</p>
	<p>Edge Profile</p>			



Cable Sleeve w/Cover

H	D	MODEL #	BLACK ONLY
1 3/8"	3 1/4"	EW1CS	\$28



Edge Grommet

H	W	D	MODEL #	BLACK ONLY
1 3/8"	2 1/4"	1 3/8"	EW1WSG	\$28

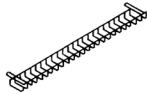

Worksurface Cable Basket

H	W	D	MODEL #	BLACK ONLY
2"	20"	4"	EW1CB20	\$55
2"	32"	4"	EW1CB32	\$76
2"	42"	4"	EW1CB42	\$82

Cable Sleeve with Cover

Used to pass cables through a worksurface. Fits 3" diameter hole, field cut, in worksurface. Smooth plastic prevents abrasion of cords and cables.

Cover snaps into sleeve. Cover has slots that allow passage of one or two cables, yet gives appearance of surface continuity.

Available in black only.

Edge Grommet

Designed to accommodate various styles and quantities of cords/plugs between rear of worksurfaces and panels for improved cord/plug management. Designed to work with Equity EW1 tops shipped after 2005.

Available in black only.

Worksurface Cable Basket

Attaches to the underside of worksurface for excess cable management. Slides forward from its position adjacent to the panel face to allow passage of plugs. Constructed of steel wire.

Available in black only.

Counter Caps Straights

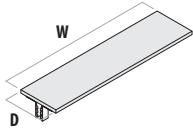

Straight

W (NOMINAL)	W (ACTUAL)	D	MODEL #	LAMINATE			PAINT		
				L1	L2	L3	P2	P3	
12"	10 1/2"	15 1/4"	EW(3/N)1215	\$320	\$352	\$384	+ \$25	+ \$50	
24"	22 1/2"	15 1/4"	EW(3/N)2415	\$340	\$374	\$408	+ \$25	+ \$50	
30"	28 1/2"	15 1/4"	EW(3/N)3015	\$345	\$380	\$414	+ \$25	+ \$50	
36"	34 1/2"	15 1/4"	EW(3/N)3615	\$350	\$385	\$420	+ \$25	+ \$50	
42"	40 1/2"	15 1/4"	EW(3/N)4215	\$365	\$402	\$438	+ \$25	+ \$50	
48"	46 1/2"	15 1/4"	EW(3/N)4815	\$390	\$429	\$468	+ \$25	+ \$50	
60"	58 1/2"	15 1/4"	EW(3/N)6015	\$425	\$468	\$510	+ \$25	+ \$50	
72"	70 1/2"	15 1/4"	EW(3/N)7215	\$480	\$528	\$576	+ \$25	+ \$50	
84"	82 1/2"	15 1/4"	EW(3/N)8415	\$530	\$583	\$636	+ \$25	+ \$50	
96"	94 1/2"	15 1/4"	EW(3/N)9615	\$570	\$627	\$684	+ \$25	+ \$50	
108"	106 1/2"	15 1/4"	EW(3/N)10815	\$620	\$682	\$744	+ \$25	+ \$50	
120"	118 1/2"	15 1/4"	EW(3/N)12015	\$675	\$743	\$810	+ \$25	+ \$50	

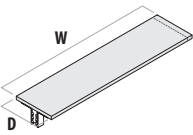

Straight – Extended One End

W	W	D	MODEL #	L1	L2	L3	P2	P3
12"	12"	15 1/4"	EW(3/N)1215E	\$330	\$363	\$396	+ \$25	+ \$50
24"	24"	15 1/4"	EW(3/N)2415E	\$350	\$385	\$420	+ \$25	+ \$50
30"	30"	15 1/4"	EW(3/N)3015E	\$355	\$391	\$426	+ \$25	+ \$50
36"	36"	15 1/4"	EW(3/N)3615E	\$360	\$396	\$432	+ \$25	+ \$50
42"	42"	15 1/4"	EW(3/N)4215E	\$375	\$413	\$450	+ \$25	+ \$50
48"	48"	15 1/4"	EW(3/N)4815E	\$400	\$440	\$480	+ \$25	+ \$50
60"	60"	15 1/4"	EW(3/N)6015E	\$435	\$479	\$522	+ \$25	+ \$50
72"	72"	15 1/4"	EW(3/N)7215E	\$490	\$539	\$588	+ \$25	+ \$50
84"	84"	15 1/4"	EW(3/N)8415E	\$540	\$594	\$648	+ \$25	+ \$50
96"	96"	15 1/4"	EW(3/N)9615E	\$580	\$638	\$696	+ \$25	+ \$50
108"	108"	15 1/4"	EW(3/N)10815E	\$630	\$693	\$756	+ \$25	+ \$50

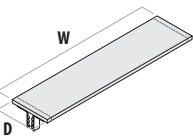

Straight – Extended Both End

W	W	D	MODEL #	L1	L2	L3	P2	P3
12"	13 1/2"	15 1/4"	EW(3/N)1215EE	\$340	\$374	\$408	+ \$25	+ \$50
24"	25 1/2"	15 1/4"	EW(3/N)2415EE	\$360	\$396	\$432	+ \$25	+ \$50
30"	31 1/2"	15 1/4"	EW(3/N)3015EE	\$365	\$402	\$438	+ \$25	+ \$50
36"	37 1/2"	15 1/4"	EW(3/N)3615EE	\$370	\$407	\$444	+ \$25	+ \$50
42"	43 1/2"	15 1/4"	EW(3/N)4215EE	\$385	\$424	\$462	+ \$25	+ \$50
48"	49 1/2"	15 1/4"	EW(3/N)4815EE	\$410	\$451	\$492	+ \$25	+ \$50
60"	61 1/2"	15 1/4"	EW(3/N)6015EE	\$445	\$490	\$534	+ \$25	+ \$50
72"	73 1/2"	15 1/4"	EW(3/N)7215EE	\$500	\$550	\$600	+ \$25	+ \$50
84"	85 1/2"	15 1/4"	EW(3/N)8415EE	\$550	\$605	\$660	+ \$25	+ \$50
96"	97 1/2"	15 1/4"	EW(3/N)9615EE	\$590	\$649	\$708	+ \$25	+ \$50
108"	109 1/2"	15 1/4"	EW(3/N)10815EE	\$640	\$704	\$768	+ \$25	+ \$50

Specify

1. Model #
2. Options
3. Surface color
4. Edge color
5. Cantilever color

Extended Ends

- E** . . . Covers 1 post
EE . . . Covers 2 posts

Application Notes

Counter caps are designed for mounting on top of panels.

Counter caps fit between posts, appropriate to fit between two taller panels and a duel/triple height connectors.

Support Information

Steel cantilevers are supplied.

Top Cap Compatibility

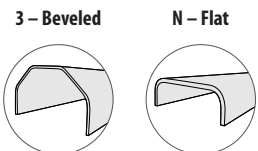

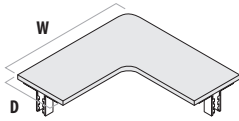

Corner

W	D	MODEL #	LAMINATE			PAINT	
			L1	L2	L3		
24"	15 1/4"	EW(3/N)CC2415	\$420	\$462	\$504	+ \$25	+ \$50
30"	15 1/4"	EW(3/N)CC3015	\$435	\$479	\$522	+ \$25	+ \$50
36"	15 1/4"	EW(3/N)CC3615	\$450	\$495	\$540	+ \$25	+ \$50

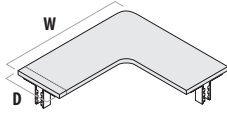

Corner – Extended Left

24"	15 1/4"	EW(3/N)CC2415LHE	\$430	\$473	\$516	+ \$25	+ \$50
30"	15 1/4"	EW(3/N)CC3015LHE	\$445	\$490	\$534	+ \$25	+ \$50
36"	15 1/4"	EW(3/N)CC3615LHE	\$460	\$506	\$552	+ \$25	+ \$50

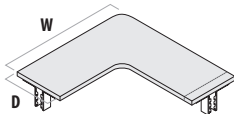

Corner – Extended Right

24"	15 1/4"	EW(3/N)CC2415RHE	\$430	\$473	\$516	+ \$25	+ \$50
30"	15 1/4"	EW(3/N)CC3015RHE	\$445	\$490	\$534	+ \$25	+ \$50
36"	15 1/4"	EW(3/N)CC3615RHE	\$460	\$506	\$552	+ \$25	+ \$50

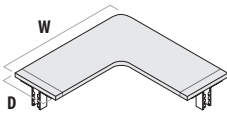

Corner – Extended Both

24"	15 1/4"	EW(3/N)CC2415EE	\$440	\$484	\$528	+ \$25	+ \$50
30"	15 1/4"	EW(3/N)CC3015EE	\$455	\$501	\$546	+ \$25	+ \$50
36"	15 1/4"	EW(3/N)CC3615EE	\$470	\$517	\$564	+ \$25	+ \$50

Specify

1. Model #
2. Options
3. Surface color
4. Edge color
5. Cantilever color

Extended Ends

- E** ... Covers 1 post
EE ... Covers 2 posts

Application Notes

Counter caps are designed for mounting on top of panels.

Counter caps fit between posts, appropriate to fit between two taller panels and a duel/triple height connectors.

Support Information

Steel cantilevers are supplied.

Top Cap Compatibility

3 – Beveled

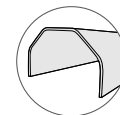

N – Flat



Shelves

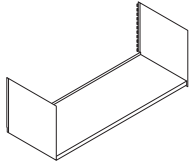

Shelf

H	W	D	MODEL #	PAINT		
				P1	P2	P3
24"	12 3/8"	10 1/4"	ES2OS24	\$232	\$247	\$257
30"	12 3/8"	10 1/4"	ES2OS30	\$254	\$269	\$279
36"	12 3/8"	10 1/4"	ES2OS36	\$254	\$269	\$279
42"	12 3/8"	10 1/4"	ES2OS42	\$266	\$281	\$291
48"	12 3/8"	10 1/4"	ES2OS48	\$278	\$293	\$303
60"	12 3/8"	10 1/4"	ES2OS60	\$298	\$313	\$323
72"	12 3/8"	10 1/4"	ES2OS72	\$322	\$337	\$347

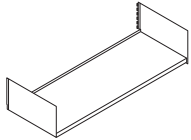

Shelf – Half Height

24"	12 3/8"	7 1/4"	ES3OS24	\$280	\$295	\$305
30"	12 3/8"	7 1/4"	ES3OS30	\$310	\$325	\$335
36"	12 3/8"	7 1/4"	ES3OS36	\$310	\$325	\$335
42"	12 3/8"	7 1/4"	ES3OS42	\$322	\$337	\$347
48"	12 3/8"	7 1/4"	ES3OS48	\$339	\$354	\$364
60"	12 3/8"	7 1/4"	ES3OS60	\$364	\$379	\$389
72"	12 3/8"	7 1/4"	ES3OS72	\$392	\$407	\$417

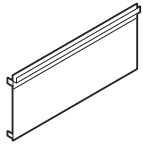

Shelf – Back

24"			EC2SB24	\$191	\$201	\$207
30"			EC2SB30	\$210	\$220	\$230
36"			EC2SB36	\$210	\$220	\$230
42"			EC2SB42	\$220	\$230	\$237
48"			EC2SB48	\$230	\$237	\$244
60"			EC2SB60	\$259	\$269	\$277
72"			EC2SB72	\$295	\$304	\$313



Shelf – Divider

2"	9"	6"	EC2SD	\$133	N/A	N/A
----	----	----	-------	-------	-----	-----

Specify

1. Model #
2. Paint trim color

Application Notes

Open shelf consists of two steel end panels and one steel shelf.

NOTE: Cannot be converted to an enclosed cabinet.

Shelf Divider

Available in dark grey only.

	W
ES2OS Open Shelf	36
ES3OS Open Shelf – Half Height	36
ES2OS	36

Panel Supported

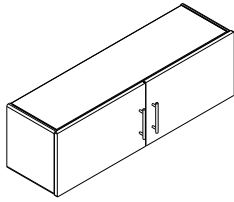

Overhead – Side Hinge Laminate Front

H	W	D	MODEL #	LAMINATE			PAINT		
				L1	L2	L3	P2	P3	
24"	12 1/2"	14 1/4"	EC2OL24	\$677	\$745	\$812	\$25	\$50	
30"	12 1/2"	14 1/4"	EC2OL30	\$727	\$800	\$872	\$25	\$50	
36"	12 1/2"	14 1/4"	EC2OL36	\$777	\$855	\$932	\$25	\$50	
42"	12 1/2"	14 1/4"	EC2OL42	\$827	\$910	\$992	\$25	\$50	
48"	12 1/2"	14 1/4"	EC2OL48	\$877	\$965	\$1,052	\$25	\$50	
60"	12 1/2"	14 1/4"	EC2OL60	\$1,227	\$1,350	\$1,472	\$25	\$50	
72"	12 1/2"	14 1/4"	EC2OL72	\$1,327	\$1,460	\$1,592	\$25	\$50	

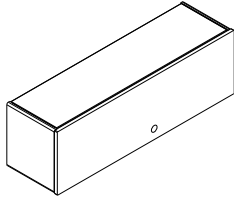

Overhead – Flipper Door

H	W	D	MODEL #	PAINT		
				P1	P2	P3
24"	12 1/2"	14 1/4"	EC2OP24	\$602	\$627	\$652
30"	12 1/2"	14 1/4"	EC2OP30	\$681	\$706	\$731
36"	12 1/2"	14 1/4"	EC2OP36	\$681	\$706	\$731
42"	12 1/2"	14 1/4"	EC2OP42	\$759	\$784	\$809
48"	12 1/2"	14 1/4"	EC2OP48	\$801	\$826	\$851
60"	12 1/2"	14 1/4"	EC2OP60	\$913	\$938	\$963
72"	12 1/2"	14 1/4"	EC2OP72	1,004	\$1,029	\$1,054
72"	12 1/2"	14 1/4"	EC2OP272*	\$1,219	\$1,244	\$1,269

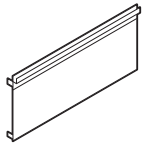

Overhead – Back

H	W	D	MODEL #	P1	P2	P3
24"	14"	5/8"	EC2CB24	\$191	\$201	\$207
30"	14"	5/8"	EC2CB30	\$210	\$220	\$230
36"	14"	5/8"	EC2CB36	\$210	\$220	\$230
42"	14"	5/8"	EC2CB42	\$220	\$230	\$237
48"	14"	5/8"	EC2CB48	\$230	\$237	\$244
60"	14"	5/8"	EC2CB60	\$259	\$269	\$277
72"	14"	5/8"	EC2CB72	\$295	\$304	\$313

Specify

1. Model #
2. Paint trim color
3. Optional Laminate

Overhead – Side Hinge

Includes matching ABS edge band

Overhead – Flipper Door

Door uses heavy-duty ball bearing hinges to allow door to flip forward and up and over top of cabinet. Can be opened at an angle. Door rolls on glides for smooth, friction-free operation.

EC2OL
EC2OP
ES2OL

Overhead – Side Hinge
Overhead – Flipper Door

W

36

36

Wall Mounted Channel



Wall Mounted Channel

W	D	H	H (Actual)	MODEL #	PAINT		
					P1	P2	P3
2 7/8"	3/4"	29"	23"	EP3WMC29	\$112	\$116	\$122
2 7/8"	3/4"	41"	35"	EP3WMC41	\$112	\$116	\$122
2 7/8"	3/4"	49"	43"	EP3WMC49	\$114	\$120	\$128
2 7/8"	3/4"	54"	49"	EP3WMC54	\$116	\$122	\$129
2 7/8"	3/4"	61"	55"	EP3WMC61	\$130	\$135	\$145
2 7/8"	3/4"	64"	60"	EP3WMC64	\$133	\$144	\$148
2 7/8"	3/4"	81"	75"	EP3WMC81	\$162	\$168	\$178
2 7/8"	3/4"	120"	120"	EP3WMC120	\$249	\$262	\$276

Specify

1. Model #
2. Paint trim color

Application Notes

Allows hanging of all components and accessories on reinforced building walls.

Painted extruded aluminum with a plastic insert which snaps in place, covering mounting screws.

NOTE: Neutral Posture, Inc. assumes no responsibility for wall construction or performance of fasteners used.

Assembly

Included

- Extruded aluminum channel
- Insert which snaps into place

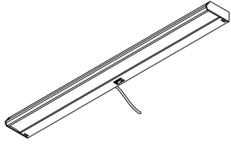

T5 – Task Light

DESCRIPTION	H	W	D	MODEL #	LIST
Use with 24" and wider overhead	1 ½"	19"	4"	EL4T5E19S	\$259
Use with 30" and wider overhead	1 ½"	25"	4"	EL4T5E25S	\$268
Use with 42" and wider overhead	1 ½"	37"	4"	EL4T5E37S	\$275
Use with 60" and wider overhead	1 ½"	49"	4"	EL4T5E49S	\$291

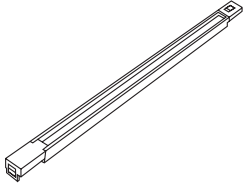

LED – Task Light

Use with 24" and wider overhead	1"	16"	1"	EL4LED16	\$495
Use with 30" and wider overhead	1"	25"	1"	EL4LED25	\$595
Use with 42" and wider overhead	1"	31"	1"	EL4LED31	\$655
Use with 60" and wider overhead	1"	37"	1"	EL4LED37	\$727

Specify

1. Model #

Application Notes

All task lights mount into the recess in the underside of overhead cabinets and shelves at least 6" wider than task light width.

All task lights are TCLP compliant and meet requirements of California Title 20 and Title 24.

T5 Task Light

120v and includes T5 cool white (4100K) fluorescent lamp, electronic ballast, 9' grounded cord-set, prismatic lens, rocker switch, one cord exit management clip and mounting hardware. Housings are black.

T5 task lights come with mounting supports.

City of Chicago Installations
Specify suffix – CH
and add \$45 list.

Example: EL4T525S-CH

LED

- Consumes only 9.4 Watts
- Color temperature: 3300 K
- Non-handed toggle switch location
- Cord location can be either end

LED task lights are magnetic and require no mounting supports.

Tables

General Info

Step 1 – Model

		Shape	D	W
TB	Table	R Round S Square RCT Rectangle OT Oval	34	69
TB		RCT	34	69

Step 1 – Surface Finish

Laminate	
PW-STK	Studio Teak
PW-STK	

Step 2 – Edge Finish

Edge Band	
EB-STK	Studio Teak
EB-STK	

Step 3 – Trim Finish

Paints	
301	Champagne
301	

FEATURES

BASE TYPES

- X Base
- Y Base w/ or w/o adjustable bar support
- Tapered Leg

BASE OPTIONS

- Bar height
- Flip top
- Casters
- Polished and Satin chrome finishes available in addition to paint

NOTE: not all options are available on all bases

WORKSURFACE TYPES

- Round
- Square
- Rectangular
- Oval

LEVELERS

Adjustable height levelers are included at no additional cost on all models. The levels are $\frac{3}{8}$ – 16 x $\frac{3}{4}$ " long shank. Leveler extensions can be ordered separately. Please contact Sales Support for information on ordering leveler extensions. Casters can be ordered in place of levelers for an upcharge on most standard height tables.

SAFETY

For safety and stability purposes, the caster and flip top options cannot be added to bar height tables or the following table models: TBR60, TBS60, TBS48, TBOT54120, TBOT60144.

CUSTOM TABLES

Custom size tables and custom height bases are available upon request, pending engineering approval. Customization charges may apply. Contact Sales Support for additional information and pricing.

CONSTRUCTION

X BASES

X bases are made from cast aluminum with 2 $\frac{1}{4}$ " tubing OD x 13 gauge.

Y BASE

Y base is made from cast aluminum with 2 $\frac{1}{4}$ " steel tube.

X BASE MOUNTING PLATES

X base mounting plates are made of steel 4 gauge x 12" x 12" or 8" x 8".

Y BASE MOUNTING PLATES

Y base mounting plates are made from 0.187" x 6" x 8" fabricated steel.

WORKSURFACES

All worksurfaces are made with a core, high pressure laminate and edge band. All non-woodgrain edge bands are made of ABS material. All woodgrain edge bands are made of PVC material. The overall thickness is 1 $\frac{1}{4}$ ".

WORKSURFACE HEIGHTS

Standard	27 $\frac{3}{4}$ "
Bar Height	40 $\frac{3}{4}$ "

SURFACE MATERIALS

WORKSURFACE

- Laminate
- Edge band

X BASES

Paint

Y BASE

Paint

TAPERED LEGS

Paint

HEIGHT ADJUSTABLE BASE

White, black or silver

TABLES

Free Standing

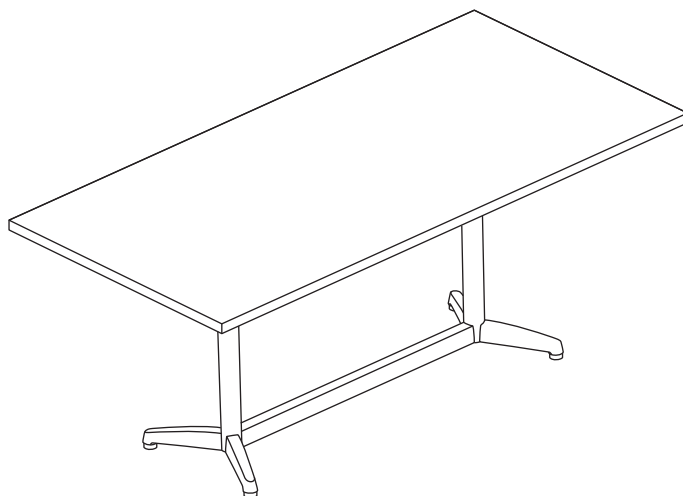

Tables

Round & Square



Round

DESCRIPTION	H	W	D	MODEL #	LAMINATE			PAINT	
					L1	L2	L3	P2	P3
X base	29"	29 3/4"	29 3/4"	TBR30	\$1,125	\$1,238	\$1,350	+ \$100	+ \$200
X base	29"	35 3/4"	35 3/4"	TBR36	\$1,150	\$1,265	\$1,380	+ \$100	+ \$200
X base	29"	41 3/4"	41 3/4"	TBR42	\$1,225	\$1,348	\$1,470	+ \$100	+ \$200
X base	29"	47 3/4"	47 3/4"	TBR48	\$1,510	\$1,661	\$1,812	+ \$100	+ \$200
4 Tapered legs	29"	59 3/4"	59 3/4"	TBR60	\$2,680	\$2,948	\$3,216	+ \$200	+ \$300



Square

DESCRIPTION	H	W	D	MODEL #	LAMINATE			PAINT	
					L1	L2	L3	P2	P3
X Base	29"	29 3/4"	29 3/4"	TBS30	\$1,125	\$1,238	\$1,350	+ \$100	+ \$200
X Base	29"	35 3/4"	35 3/4"	TBS36	\$1,200	\$1,320	\$1,440	+ \$100	+ \$200
X Base	29"	41 3/4"	41 3/4"	TBS42	\$1,250	\$1,375	\$1,500	+ \$100	+ \$200
4 Tapered Legs	29"	47 3/4"	47 3/4"	TBS48	\$1,650	\$1,815	\$1,980	+ \$200	+ \$300
4 Tapered Legs	29"	59 1/2"	59 1/2"	TBS60	\$2,550	\$2,805	\$3,060	+ \$200	+ \$300

Options for Round & Square Tables

DESCRIPTION	OPTION CODE	UPCHARGE
Bar height	BH	+ \$100
Casters (set of 4)	C	+ \$100
Flip top	FT	+ \$200

Flip top is not available on tapered legs.

Free Standing

Specify

1. Model #
2. Surface finish
3. Edge finish
4. Trim finish

Wood Grain

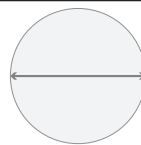

Shape		D
TB Table	R Round	30
	S Square	
	RCT Rectangle	
	OT Oval	
TB	R	30



Rectangle

DESCRIPTION	H	W	D	MODEL #	LAMINATE			PAINT	
					L1	L2	L3	P2	P3
Y base w/o stretcher	29"	47 3/4"	29 3/4"	TBRCT3048	\$1,415	\$1,557	\$1,698	+ \$200	+ \$300
Y base w/stretcher	29"	58 1/2"	35 1/2"	TBRCT3660	\$2,035	\$2,239	\$2,442	+ \$200	+ \$300
Y base w/stretcher	29"	59 3/4"	29 3/4"	TBRCT3060	\$1,725	\$1,898	\$2,070	+ \$200	+ \$300
Y base w/stretcher	29"	69 1/4"	34"	TBRCT3469	\$3,065	\$3,372	\$3,678	+ \$200	+ \$300
Y base w/stretcher	29"	71 3/4"	29 3/4"	TBRCT3072	\$2,035	\$2,239	\$2,442	+ \$200	+ \$300
Y base w/stretcher	29"	71 3/4"	35 3/4"	TBRCT3672	\$2,415	\$2,657	\$2,898	+ \$200	+ \$300
Y base w/stretcher	29"	79 1/4"	34"	TBRCT3479	\$3,065	\$3,372	\$3,678	+ \$200	+ \$300
Y base w/stretcher	29"	83 3/4"	41 3/4"	TBRCT4284	\$3,230	\$3,553	\$3,876	+ \$200	+ \$300
Y base w/stretcher	29"	95 3/4"	47 3/4"	TBRCT4896	\$4,165	\$4,582	\$4,998	+ \$200	+ \$300

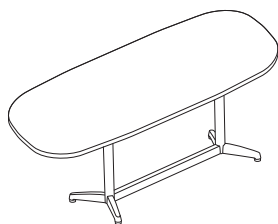

Oval

Y base w/stretcher	29"	71 3/4"	35 3/4"	TBOT3672	\$3,190	\$3,509	\$3,828	+ \$200	+ \$300
Y base w/stretcher	29"	95 3/4"	47"	TBOT4896	\$5,225	\$5,748	\$6,270	+ \$200	+ \$300
Y base w/stretcher	29"	119 3/4"	47"	TBOT48120	\$6,395	\$7,035	\$7,674	+ \$200	+ \$300
6 Tapered legs	29"	119 3/4"	53 3/4"	TBOT54120	\$6,900	\$7,590	\$8,280	+ \$250	+ \$350
6 Tapered legs	29"	143 3/4"	59 3/4"	TBOT60144	\$7,500	\$8,250	\$9,000	+ \$250	+ \$350

Options for Rectangle & Oval Tables

DESCRIPTION	OPTION CODE	UPCHARGE
Bar height	BH	+ \$300
Casters (set of 4)	C	+ \$100
Flip top	FT	+ \$300

Casters & flip top are not available on tapered legs.

Free Standing

Specify

1. Model #
2. Surface finish
3. Edge finish
4. Trim finish

Wood Grain

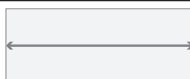

		Shape	D	W
TB	Table	R Round S Square RCT Rectangle OT Oval	34	69
TB		RCT	34	69

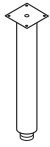

Column Bases

DESCRIPTION	H	MODEL #	LAMINATE		
			L1	L2	L3
Fixed height support column	27 ¾"	EB1FCOL	\$320	\$348	\$362

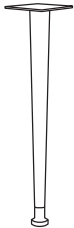

Tapered Legs

DESCRIPTION	H	MODEL #	PAINT		
			P1	P2	P3
Single leg	27 ¾"	TBTL	\$350	\$385	\$420
Single leg w/caster	27 ¾"	TBTL C	\$375	\$410	\$445
Set of 2	27 ¾"	TBTL2	\$600	\$660	\$720
Set of 2 w/casters	27 ¾"	TBTL2C	\$650	\$710	\$770
Set of 4	27 ¾"	TBTL4	\$1,150	\$1,265	\$1,380
Set of 4 w/casters	27 ¾"	TBTL4C	\$1,250	\$1,365	\$1,480



Height Adjustable Base

DESCRIPTION	MODEL #	BLACK, SILVER OR WHITE ONLY
2 legs	TBAHL2	\$2,700
3 legs	TBAHL3	\$4,500

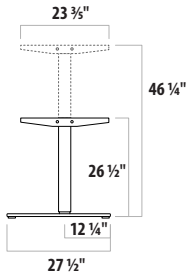
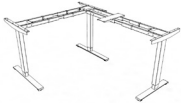

Free Standing

Specify

1. Model #
2. Options
3. Surface color
4. Edge color
5. Trim color

Application Notes

Adjustable height bases can be used with 24" & 30" deep worksurfaces. Worksurfaces must be between 48 – 84" wide.

Adjustable height bases have a capacity of 275 lbs. evenly distributed.

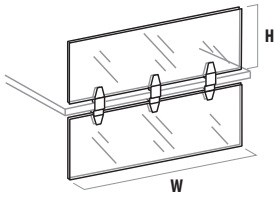

Privacy/Modesty Panels

W	H	# BRACKETS INCLUDED	MODEL #	PG	LAMINATE		
					L1	L2	L3
12"	12"	2	PRVMOD(PG/LM)12	\$337	\$297	\$327	\$356
18"	12"	2	PRVMOD(PG/LM)18	\$377	\$327	\$360	\$392
24"	12"	2	PRVMOD(PG/LM)24	\$427	\$377	\$415	\$452
30"	12"	2	PRVMOD(PG/LM)30	\$477	\$427	\$470	\$512
36"	12"	2	PRVMOD(PG/LM)36	\$527	\$477	\$525	\$572
42"	12"	2	PRVMOD(PG/LM)42	\$577	\$527	\$580	\$632
48"	12"	2	PRVMOD(PG/LM)48	\$677	\$577	\$635	\$692
60"	12"	3	PRVMOD(PG/LM)60	\$807	\$677	\$745	\$812

Specify

1. Model #
 2. Insert color
- Trim - Brushed nickel only

Plexiglass Finishes

- IC** . . . Ice
SM . . . Smoked
TR . . . Translucent
LF . . . Frost

Application Notes

Screens are ¼" thick.

Widths are 1" less than nominal to allow for ½" set-back on each side.

These brackets are only available in privacy & modesty sets and cannot be sold separately.

STORAGE

Neutral Posture is not only dedicated to good posture, we are also dedicated to making offices more efficient and more enjoyable to work in. Neutral Posture knows that to increase efficiency in the office things must be organized well and be easily accessible. Neutral Posture offers the most space efficient and easily accessible products on the market.

Neutral Posture offers many diverse storage units making sure you can always find the exact unit of storage for your office's needs. From small pedestals that can double as seating to large towers with wardrobe capability, Neutral Posture can fit your needs in any situation. Along with our wide range of storage options, Neutral Posture also lets you truly personalize your office equipment, making your office a welcoming place for not only your customers, but, your employees as well.

Neutral Posture provides storage units that work together--meaning that they will work better for you and your workspace. Neutral Posture allows customization by offering several different color options, fabric patterns and even several different pulls and lock options to make sure your office space looks exactly how you want. Storage units that are cohesive have numerous benefits, such as taking up less space, being easier to access and making your office look more unified.

TRUE DIMENSIONS

Disclaimer: While Equity panels and worksurfaces are based on centerline to centerline dimensions, all storage dimensions are true dimensions.

STORAGE



Storage

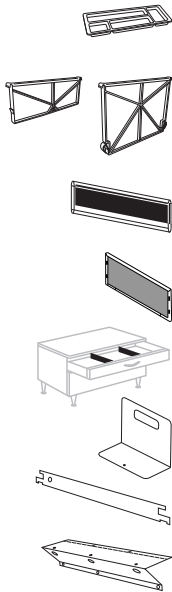

Pencil tray	SPTRY	\$17
6" Drawer divider	SBDD	\$17
12" Drawer divider	SFDD	\$37
Magnetic label	SMLB	\$67
Ped drawer front filler	SPFF	\$66
Magnetic drawer dividers	SMDDB	\$97
Magnetic shelf divider	SMSD	\$77
Lateral file conversion bar	SLFCB	\$77
Worksurface supporting bracket	SWSSB	\$97

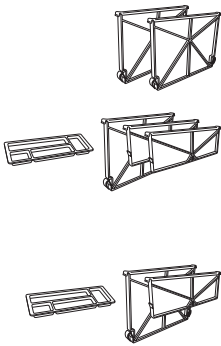

PED ACCESSORY PACKAGE – FF









2 – 12" drawer dividers	SFFA	\$67
-------------------------	-------------	------

PED ACCESSORY PACKAGE – BBF

2 – 6" drawer dividers	SBBFA	\$77
1 – 12" drawer dividers		
1 – Pencil tray		

PED ACCESSORY PACKAGE – BF

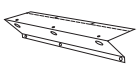
1 – 6" drawer divider	SBFA	\$67
1 – 12" drawer divider		
1 – Pencil tray		

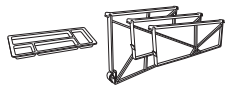
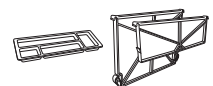
	PEDESTALS	LATERALS	TOWERS	CRENZAS	CABINETS	LOCKERS	BOOKCASES
 Pencil tray	•	•	•				
 Drawer dividers	•		•				
 Magnetic label	•	•	•	•			
 Ped drawer front filler	•		•				
 Magnetic drawer dividers		•		•			
 Magnetic shelf divider			•	•	•		•
 Lateral file conversion bar		•					
 Worksurface supporting bracket			•				
 Ped accessory package – FF	•		•				
 Ped accessory package – BBF	•		•				
 Ped accessory package – BF	•						

Pedestals

General Info

Step 1 – Model

Pedestal	Drawers	D	Pull
SPED Freestanding Pedestal	FF File File	19	J J Pull
SMPED Mobile Pedestal	BBF Box Box File		B Bar Pull
SCMPED Mobile Pedestal w/Cushion	BF Box File		R Radiused Pull
SSPED Suspended Pedestal			
SWSPED Worksurface Supporting Pedestal			
SWSLKR Worksurface Supporting Locker			
SFC File Center			
SPED	BBF	19	J

Step 2 – Case Finish

Paints
301 Champagne
301

Step 3 – Front Finish

Not Available w/J Pull	
Laminate	
PW-STK	Studio Teak
PW-STK	

FEATURES

COUNTER WEIGHTS

- Freestanding, mobile and cushion pedestals include factory installed counterweights
- Counterweights are not necessary for worksurface supporting or suspended pedestals

LOCK

- Lock core is removable
- Keyed alike available upon request
- Master and change key available upon request
- Individual locking drawers available upon request

DRAWERS

- Include full suspension steel ball-bearing slides
- Drawer fronts include rubber bumpers for quiet operation

LEVELING GLIDES

4 Leveling glides allow for 1 5/8" adjustment.

CASTERS – MOBILE PEDS

- 4 Casters – black
- 2 Locking

CONSTRUCTION

OUTER SHELL & DRAWER CONSTRUCTION

Welded steel frame construction & formed channels ensure strength in key areas

Top channels	18 – 21 gauge
Side channels	18 – 21 gauge
Outer panels	22 gauge
Drawer fronts	20 gauge
Drawer bins	22 gauge

DRAWER LOAD CAPACITY

6" Bow drawers	50 lbs
12" File drawers	70 lbs

DRAWER INNER DIMENSIONS

Height

Box drawer	4 1/2"
File drawer	9 1/2"

Width

All drawers	12 1/8"
-------------	---------

Depth

18" Deep pedestal	15 1/5"
22" Deep pedestal	18 1/4"

PED LOCKER INNER DIMENSIONS

	H	W	D
18" Deep	23"	13 3/4"	17"
22" Deep	23"	13 3/4"	21"

PULL STYLES

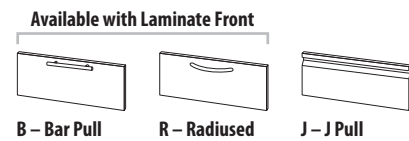

SURFACE MATERIALS

PEDESTAL

Paint

FRONTS

w/Bar pull (B)	Paint or Laminate
w/Radiused pull (R)	Paint or Laminate
w/J pull (J)	Paint

DRAWER PULL

Bar (B)	Satin nickel
Radiused (R)	Satin nickel
J (J)	Paint

MOBILE PED HANDLE

Satin nickel

LOCK

Satin nickel

CUSHION TOP

Upholstery

PEDESTALS

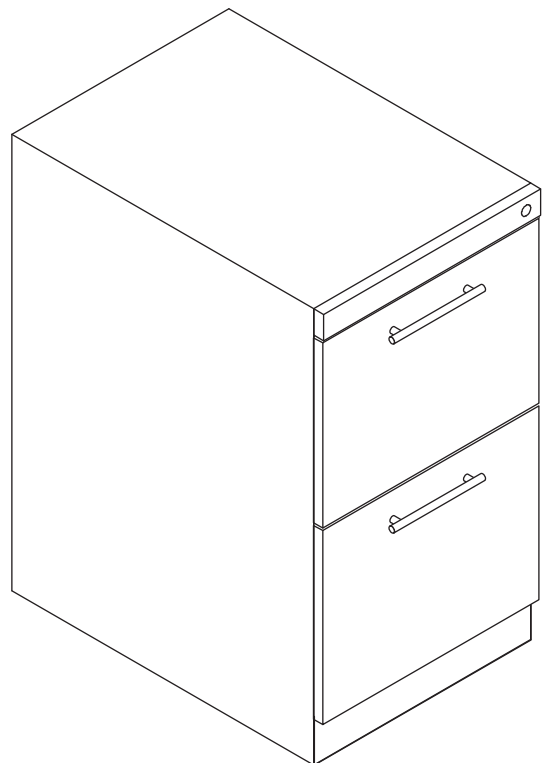

Storage

Pedestals



Freestanding

H	W	D	MODEL #	PAINT			LAMINATE FRONT (OPTIONAL)		
				P1	P2	P3	L1	L2	L3
27 3/4"	15 1/4"	21 7/8"	SPEDFF22(J/B/R)	\$597	\$657	\$716	+\$260	+\$286	+\$312
27 3/4"	15 1/4"	21 7/8"	SPEDBBF22(J/B/R)	\$637	\$701	\$764	+\$280	+\$308	+\$336



Mobile

26 7/8"	15 1/4"	18 7/8"	SMPEDFF19(J/B/R)	\$577	\$635	\$692	+\$250	+\$275	+\$300
26 7/8"	15 1/4"	18 7/8"	SMPEDBF19(J/B/R)	\$597	\$657	\$716	+\$260	+\$286	+\$312
21 7/8"	15 1/4"	18 7/8"	SMPEDBBF19(J/B/R)	\$647	\$712	\$776	+\$285	+\$314	+\$342
21 7/8"	15 1/4"	21 7/8"	SMPEDFF22(J/B/R)	\$637	\$701	\$764	+\$280	+\$308	+\$336
26 7/8"	15 1/4"	21 7/8"	SMPEDBBF22(J/B/R)	\$677	\$745	\$812	+\$300	+\$330	+\$360
26 7/8"	15 1/4"	21 7/8"	SMPEDBF22(J/B/R)	\$587	\$646	\$704	+\$250	+\$275	+\$300



Mobile w/Cushion

23"	15 1/4"	18 7/8"	SCMPEDBF19(J/B/R)	\$777	\$855	\$932	+\$320	+\$352	+\$384
23"	15 1/4"	21 7/8"	SCMPEDBF22(J/B/R)	\$787	\$866	\$944	+\$330	+\$363	+\$396

Mobile Cushion Fabric Upcharges

UPHOLSTERY GRADES		UPCHARGE
SEATING	SYSTEMS	
C	A	+\$120
1	B	+\$190
2	C	+\$220
3	D	+\$290
4	E	+\$320
5	F	+\$390
6	G	+\$450
	H	+\$500

Specify

1. Model #
2. Case finish
3. Front finish
Laminate not available on J pull

Pulls

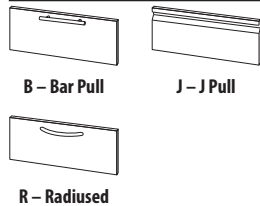

Ordered Separately

- Pencil tray

Freestanding Peds

- Included**
- Counterweight for stability
 - Leveling glides allow for 1/8" adjustment

Mobile Peds

- Included**
- Black 37mm plastic casters (2 locking & 2 non-locking)
 - Counterweight for stability
 - 1 1/2" cushion in black
- Other fabrics available for an upcharge.*

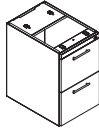

Suspended

H	W	D	MODEL #	PAINT			LAMINATE FRONT (OPTIONAL)		
				P1	P2	P3	L1	L2	L3
25"	15 1/4"	21 7/8"	SSPEDFF22(J/B/R)	\$637	\$701	\$764	+\$280	+\$308	+\$336
25"	15 1/4"	21 7/8"	SSPEDBBF22(J/B/R)	\$597	\$657	\$716	+\$260	+\$286	+\$312
19 3/8"	15 1/4"	21 7/8"	SSPEDBF22(J/B/R)	\$497	\$547	\$596	+\$215	+\$237	+\$258



Worksurface Supporting

27 3/4"	15 1/4"	17 7/8"	SWSPEDFF18(J/B/R)	\$577	\$635	\$692	+\$255	+\$281	+\$306
27 3/4"	15 1/4"	17 7/8"	SWSPEDBBF18(J/B/R)	\$617	\$679	\$740	+\$270	+\$297	+\$324
27 3/4"	15 1/4"	21 7/8"	SWSPEDFF22(J/B/R)	\$577	\$635	\$692	+\$255	+\$281	+\$306
27 3/4"	15 1/4"	21 7/8"	SWSPEDBBF22(J/B/R)	\$617	\$679	\$740	+\$270	+\$297	+\$324

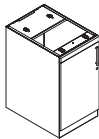

Worksurface Supporting Locker

27 3/4"	15 1/4"	17 7/8"	SWSLKR22R(J/B/R)	\$727	\$800	\$872	N/A	N/A	N/A
27 3/4"	15 1/4"	17 7/8"	SWSLKR22L(J/B/R)	\$727	\$800	\$872	N/A	N/A	N/A

SWSLKR22(R/L)(J/B/R) — (R/L) refers to the hinge location

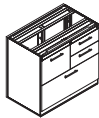

Worksurface Supporting File Center

27 3/4"	30 1/2"	18 1/4"	SFCFFLAT(J/B)	\$1,177	\$1,295	\$1,412	+\$520	+\$572	+\$624
27 3/4"	30 1/2"	18 1/4"	SFCBBFLAT(J/B)	\$1,227	\$1,350	\$1,472	+\$540	+\$594	+\$648
27 3/4"	30 1/2"	18 1/4"	SFCFBBLAT(J/B)	\$1,227	\$1,350	\$1,472	+\$540	+\$594	+\$648

Specify

1. Model #
2. Case finish
3. Front finish
Laminate not available on J Pull

Pulls

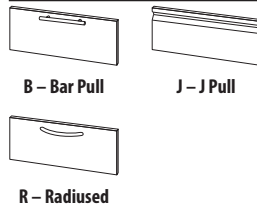

Worksurface Supporting Peds

- Included**
- Leveling glides allow for 1 5/8" adjustment
- May not be used in freestanding applications.

Worksurface Supporting Locker

- Included**
- Leveling glides allow for 1 5/8" adjustment
 - 1 adjustable shelf and accommodates binder height storage on 1 shelf

File Center

- All drawers include full-extension steel ball bearing slides.
- Counter weight is not required when used to support a worksurface.

Laterals

General Info

Step 1 – Model

Lateral	# of Drawers	W	Pull
SLAT Lateral SWSLAT Worksurface Supporting	3	36	J J Pull B Bar Pull
SLAT	3	36	J

Step 2 – Case Finish

Paint
301 Champagne
301

Step 3 – Front Finish

Not Available w/J Pull	
Laminate	
PW-STK	Studio Teak
PW-STK	

FEATURES

COUNTER WEIGHTS

- Counterweights are not included with laterals
- Counterweights are not necessary for worksurface supporting or suspended pedestals

LOCK

- Lock core is removable
- Keyed alike available upon request
- Master and change key available upon request
- Individual locking drawers available upon request, upcharge may apply

DRAWERS

- All drawers include full extension steel ball-bearing slides with anti-rebound features to ensure smooth operation
- Drawer fronts include rubber bumpers for quiet operation
- The top opening of 5-high laterals features an over-the-top flipper door with 13 1/4" inside clear height for binder storage
- Drawer includes full-height side panels
- 2 file bars are included in each drawer, for side-to-side filing
- Conversion bars for front to back filing are sold separately
- All lateral drawer bins will accommodate A4, letter, and legal size filing

LEVELING GLIDES

4 leveling glides allow for 1 1/4" adjustment.

CONSTRUCTION

OUTER SHELL & DRAWER CONSTRUCTION

Welded steel frame construction & formed channels ensure strength in key areas. Standard depth is 18 1/4".

Inner frame	20 gauge
Outer panels	22 gauge
Drawer fronts	20 gauge
Drawer bins	20 gauge

DRAWER LOAD CAPACITY

30" Wide lateral	140 lbs
36" Wide lateral	168 lbs
42" Wide lateral	192 lbs

DRAWER INNER DIMENSIONS

Height	
Top flipper door	13 1/4"
Drawer immediately below lock strip	9 2/5"
All other drawers	10 3/4"

Width

30" Wide lateral	26 7/10"
36" Wide lateral	32 7/10"
42" Wide lateral	38 7/10"

Depth

18 1/4" Deep lateral	16"
----------------------	-----

PULL STYLES

Available with Laminate Front



B – Bar Pull



J – J Pull

SURFACE MATERIALS

LATERAL

Paint

FRONTS

w/Bar pull (B)	Paint or Laminate
w/J pull (J)	Paint

DRAWER PULL

Bar (B)	Satin nickel
J (J)	Paint

LOCK

Satin nickel

TOP

Paint or Laminate

LATERALS

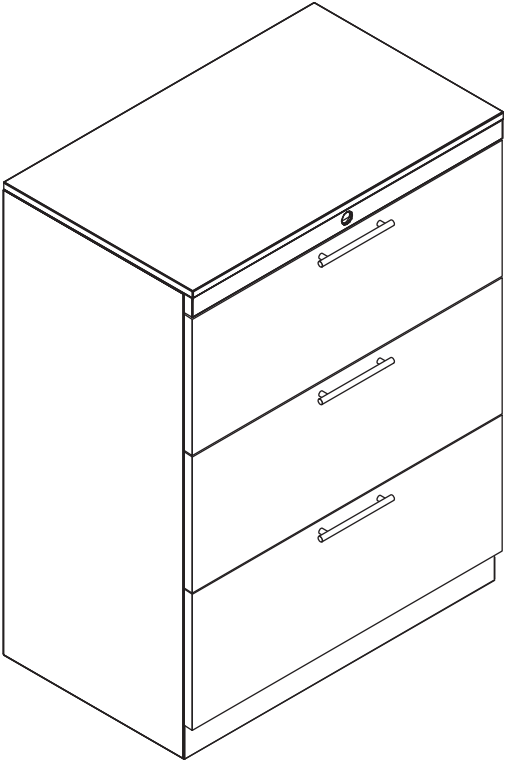

Storage

Laterals



2 Drawer

H	W	D	MODEL #	PAINT			LAMINATE FRONT (OPTIONAL)		
				P1	P2	P3	L1	L2	L3
28 3/8"	30"	18 1/4"	SLAT230(J/B)	\$897	\$987	\$1,076	+ \$400	+ \$440	+ \$528
28 3/8"	36"	18 1/4"	SLAT236(J/B)	\$1,097	\$1,207	\$1,316	+ \$440	+ \$484	+ \$581
28 3/8"	42"	18 1/4"	SLAT242(J/B)	\$1,147	\$1,262	\$1,376	+ \$480	+ \$528	+ \$634



3 Drawer

39 7/8"	30"	18 1/4"	SLAT330(J/B)	\$1,247	\$1,372	\$1,496	+ \$550	+ \$605	+ \$726
39 7/8"	36"	18 1/4"	SLAT336(J/B)	\$1,397	\$1,537	\$1,676	+ \$590	+ \$649	+ \$779
39 7/8"	42"	18 1/4"	SLAT342(J/B)	\$1,497	\$1,647	\$1,796	+ \$630	+ \$693	+ \$832

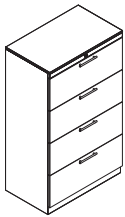

4 Drawer

51 3/8"	30"	18 1/4"	SLAT430(J/B)	\$1,547	\$1,702	\$1,856	+ \$670	+ \$737	+ \$884
51 3/8"	36"	18 1/4"	SLAT436(J/B)	\$1,697	\$1,867	\$2,036	+ \$700	+ \$770	+ \$924
51 3/8"	42"	18 1/4"	SLAT442(J/B)	\$1,797	\$1,977	\$2,156	+ \$730	+ \$803	+ \$964

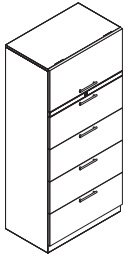

5 Drawer

65 7/8"	30"	18 1/4"	SLAT530(J/B)	\$1,847	\$2,032	\$2,216	+ \$740	+ \$814	+ \$977
65 7/8"	36"	18 1/4"	SLAT536(J/B)	\$1,997	\$2,197	\$2,396	+ \$760	+ \$836	+ \$1,003
65 7/8"	42"	18 1/4"	SLAT542(J/B)	\$2,197	\$2,417	\$2,636	+ \$780	+ \$858	+ \$1,030

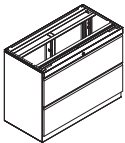

Worksurface Supporting

27 3/4"	30"	18 1/4"	SWSLAT230(J/B)	\$897	\$987	\$1,076	+ \$400	+ \$440	+ \$528
27 3/4"	36"	18 1/4"	SWSLAT236(J/B)	\$997	\$1,097	\$1,196	+ \$440	+ \$484	+ \$581
27 3/4"	42"	18 1/4"	SWSLAT242(J/B)	\$1,097	\$1,207	\$1,316	+ \$480	+ \$528	+ \$634

Specify

1. Model #
2. Case finish
3. Front finish
Laminate not available on J pull

Application Notes

- Included**
- Counterweight for stability
 - Leveling glides for 1 3/8" adjustment

Pulls

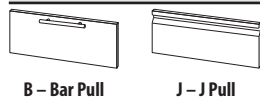

B – Bar Pull

J – J Pull

Lateral	# of Drawers	W	Pull
SLAT Lateral	3	36	J J Pull
SWSLAT Worksurface Supporting	3	36	B Bar Pull
SLAT	3	36	J

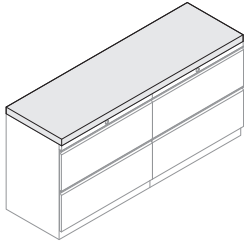

Common Tops

DESCRIPTION	H	W	D	MODEL #	LAMINATE		
					L1	L2	L3
Single 30" W lateral top	5/8"	30"	18 1/4"	LT30	\$350	\$385	\$420
Single 36" W lateral top	5/8"	36"	18 1/4"	LT36	\$380	\$418	\$456
Double 30" W lateral top	5/8"	60"	18 1/4"	LT60	\$410	\$451	\$492
Double 30" W/36" W lateral top	5/8"	66"	18 1/4"	LT66	\$465	\$512	\$558
Double 36" W lateral top	5/8"	72"	18 1/4"	LT72	\$485	\$534	\$582
Triple 30" W lateral top	5/8"	90"	18 1/4"	LT90	\$495	\$545	\$594
Triple 36" W lateral top	5/8"	108"	18 1/4"	LT108	\$530	\$583	\$636

Specify

1. Model #
2. Body color
3. Front finish
Laminate not available on J pull

Towers

General Info

Step 1 – Model

		H	W	Drawers	Coat Door	Pull
STWR	Tower	56	22	FF BBF	L Left R Right	J J Pull B Bar Pull R Radiused Pull
STWR		56	22	FF	L	J

Step 2 – Case Finish

Paint
301 Champagne
301

Step 3 – Front Finish

Not Available w/J Pull	
Laminate	
PW-STK	Studio Teak
PW-STK	

FEATURES

LOCK

- Lock core is removable
- 24" Side access tower includes 2 locks. All others include 1 lock
- Keyed alike available upon request
- Master and change key available upon request
- Individual locking drawers available upon request

DRAWERS

- Include full suspension steel ball-bearing slides
- Drawer fronts include rubber bumpers for quiet operation
- Slides include anti-rebound and quick disconnect features
- File drawer dividers which allow side-to-side filing are sold separately

SHELVES

Shelves are adjustable in 1 ½" increments.

LEVELING GLIDES – TOWER

Leveling glides allow for 7/8" adjustment.

LEVELING GLIDES – SIDE ACCESS TOWER

Leveling glides allow for 1 5/8" adjustment.

DOORS

Cupboard and coat doors include concealed hinges that allow for 110° degree opening.

CONSTRUCTION

OUTER SHELL & DRAWER CONSTRUCTION

Welded steel frame construction & formed channels ensure strength in key areas.

Inner top channel	18 gauge
Bottom channel	18 gauge
Side channels	18 gauge
Outer top	21 gauge
Outer back	21 gauge
Outer sides	21 gauge
Outer center	21 gauge
Drawer & door fronts	21 gauge
Shelves	18 gauge
Drawer bins	22 gauge
Drawer fronts	20 gauge

DRAWER LOAD CAPACITY

6" Bow drawers	50 lbs
12" File drawers	70 lbs

SHELF LOAD CAPACITY

Shelf	61 lbs
-------	--------

DRAWER INNER DIMENSIONS

Height

Box drawer	4 ½"
File drawer	9 ½"

Width

All drawers	12 ½"
-------------	-------

Depth

All drawers	18 ¼"
-------------	-------

PULL STYLES

Available with Laminate Front



SURFACE MATERIALS

CASE

Paint

FRONTS

w/Bar Pull (B)	Paint or Laminate
w/Radiused Pull (R)	Paint or Laminate
w/J Pull (J)	Paint

NOTE: Laminate is not available on 24" side access towers, 15" towers or 15" side access towers.

DRAWER PULL

Bar (B)	Satin nickel
Radiused (R)	Satin nickel
J (J)	Paint

LOCK

Satin nickel

TOWERS

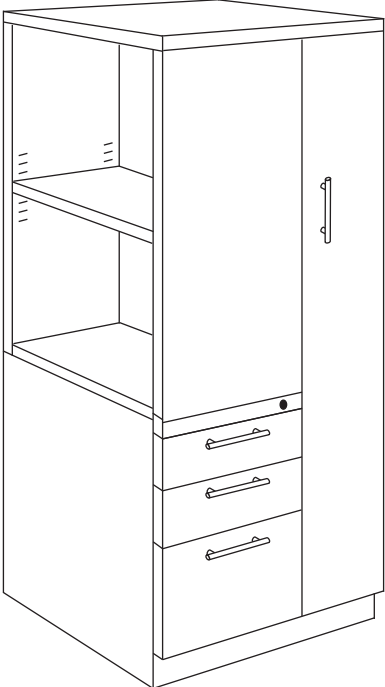

Storage

Towers

24" Wide

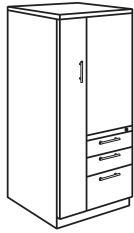

STWR5624BBFLB

46" High — does not include an adj. shelf

COAT DOOR	H	W	D	MODEL #	PAINT			LAMINATE FRONT (OPTIONAL)		
					P1	P2	P3	L1	L2	L3
L	46"	23 1/2"	23 1/2"	STWR4624FFL(J/B/R)	\$2,097	\$2,307	\$2,516	+ \$920	+ \$1,012	+ \$1,104
R	46"	23 1/2"	23 1/2"	STWR4624FFR(J/B/R)	\$2,097	\$2,307	\$2,516	+ \$920	+ \$1,012	+ \$1,104
L	46"	23 1/2"	23 1/2"	STWR4624BBFL(J/B/R)	\$2,147	\$2,362	\$2,576	+ \$950	+ \$1,045	+ \$1,140
R	46"	23 1/2"	23 1/2"	STWR4624BBFR(J/B/R)	\$2,147	\$2,362	\$2,576	+ \$950	+ \$1,045	+ \$1,140

51" High — includes 2 adj. shelves

L	51 3/8"	23 1/2"	23 1/2"	STWR5124FFL(J/B/R)	\$2,147	\$2,362	\$2,576	+ \$950	+ \$1,045	+ \$1,140
R	51 3/8"	23 1/2"	23 1/2"	STWR5124FFR(J/B/R)	\$2,147	\$2,362	\$2,576	+ \$950	+ \$1,045	+ \$1,140
L	51 3/8"	23 1/2"	23 1/2"	STWR5124BBFL(J/B/R)	\$2,197	\$2,417	\$2,636	+ \$970	+ \$1,067	+ \$1,164
R	51 3/8"	23 1/2"	23 1/2"	STWR5124BBFR(J/B/R)	\$2,197	\$2,417	\$2,636	+ \$970	+ \$1,067	+ \$1,164

56" High — includes 2 adj. shelves

L	56"	23 1/2"	23 1/2"	STWR5624FFL(J/B/R)	\$2,197	\$2,417	\$2,636	+ \$970	+ \$1,067	+ \$1,164
R	56"	23 1/2"	23 1/2"	STWR5624FFR(J/B/R)	\$2,197	\$2,417	\$2,636	+ \$970	+ \$1,067	+ \$1,164
L	56"	23 1/2"	23 1/2"	STWR5624BBFL(J/B/R)	\$2,297	\$2,527	\$2,756	+ \$1,000	+ \$1,100	+ \$1,200
R	56"	23 1/2"	23 1/2"	STWR5624BBFR(J/B/R)	\$2,297	\$2,527	\$2,756	+ \$1,000	+ \$1,100	+ \$1,200

66" High — includes 3 adj. shelves

L	65 7/8"	23 1/2"	23 1/2"	STWR6624FFL(J/B/R)	\$2,397	\$2,637	\$2,876	+ \$1,200	+ \$1,320	+ \$1,440
R	65 7/8"	23 1/2"	23 1/2"	STWR6624FFR(J/B/R)	\$2,397	\$2,637	\$2,876	+ \$1,200	+ \$1,320	+ \$1,440
L	65 7/8"	23 1/2"	23 1/2"	STWR6624BBFL(B/R)	\$2,447	\$2,692	\$2,936	+ \$1,300	+ \$1,430	+ \$1,560
R	65 7/8"	23 1/2"	23 1/2"	STWR6624BBFR(B/R)	\$2,447	\$2,692	\$2,936	+ \$1,300	+ \$1,430	+ \$1,560

STWR	Tower	H	W	Drawers	Coat Door	Pull
		56	22	FF BBF	L Left R Right	J J Pull B Bar Pull R Radiused Pull
STWR		56	22	FF	L	J

Specify

- Model #
- Case finish
- Front finish
Laminate not available on J pull

Pulls

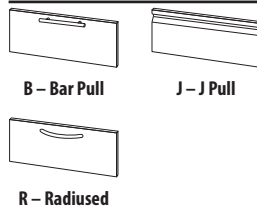

Application Notes

- Single lock for all doors & drawers
- Coat closet includes side-to-side coat rod
- Leveling glides allow for 7/8" adjustment

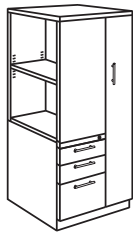

SSAT5624FFRB

46" High — does not include an adj. shelf

COAT DOOR	H	W	D	MODEL #	PAINT		
					P1	P2	P3
L	46"	23 1/2"	23 1/2"	SSAT4624FFL(J/B/R)	\$2,077	\$2,285	\$2,492
R	46"	23 1/2"	23 1/2"	SSAT4624FFR(J/B/R)	\$2,077	\$2,285	\$2,492
L	46"	23 1/2"	23 1/2"	SSAT4624BBFL(J/B/R)	\$2,127	\$2,340	\$2,552
R	46"	23 1/2"	23 1/2"	SSAT4624BBFR(J/B/R)	\$2,127	\$2,340	\$2,552

51" High — includes 2 adj. shelves

L	51 3/8"	23 1/2"	23 1/2"	SSAT5124FFL(J/B/R)	\$2,147	\$2,362	\$2,576
R	51 3/8"	23 1/2"	23 1/2"	SSAT5124FFR(J/B/R)	\$2,147	\$2,362	\$2,576
L	51 3/8"	23 1/2"	23 1/2"	SSAT5124BBFL(J/B/R)	\$2,197	\$2,417	\$2,636
R	51 3/8"	23 1/2"	23 1/2"	SSAT5124BBFR(J/B/R)	\$2,197	\$2,417	\$2,636

56" High — includes 2 adj. shelves

L	56"	23 1/2"	23 1/2"	SSAT5624FFL(J/B/R)	\$2,227	\$2,450	\$2,672
R	56"	23 1/2"	23 1/2"	SSAT5624FFR(J/B/R)	\$2,227	\$2,450	\$2,672
L	56"	23 1/2"	23 1/2"	SSAT5624BBFL(J/B/R)	\$2,327	\$2,560	\$2,792
R	56"	23 1/2"	23 1/2"	SSAT5624BBFR(J/B/R)	\$2,327	\$2,560	\$2,792

66" High — includes 3 adj. shelves

L	65 7/8"	23 1/2"	23 1/2"	SSAT6524FFL(J/B/R)	\$2,347	\$2,582	\$2,816
R	65 7/8"	23 1/2"	23 1/2"	SSAT6524FFR(J/B/R)	\$2,347	\$2,582	\$2,816
L	65 7/8"	23 1/2"	23 1/2"	SSAT6524BBFL(J/B/R)	\$2,397	\$2,637	\$2,876
R	65 7/8"	23 1/2"	23 1/2"	SSAT6524BBFR(J/B/R)	\$2,397	\$2,637	\$2,876

		H	W	Drawers	Coat Door	Pull
SSAT	Side Access Tower	56	22	FF BBF	L Left R Right	J J Pull B Bar Pull R Radiused Pull
SSAT		56	22	FF	L	J

Specify

1. Model #
2. Case finish

Pulls

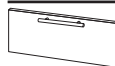

B – Bar Pull



J – J Pull



R – Radiused

Application Notes

- Includes 2 locks, keyed alike
- Coat closet includes side-to-side coat rod
- Leveling glides allow for 1 5/8" adjustment

Towers

15" Wide



STWR5615FFLB

46" High — does not include an adj. shelf

HINGE	H	W	D	MODEL #	PAINT		
					P1	P2	P3
L	46"	15 1/4"	23 1/2"	STWR4615FFL(J/B/R)	\$1,347	\$1,482	\$1,616
R	46"	15 1/4"	23 1/2"	STWR4615FFR(J/B/R)	\$1,347	\$1,482	\$1,616
L	46"	15 1/4"	23 1/2"	STWR4615BBFL(J/B/R)	\$1,477	\$1,625	\$1,772
R	46"	15 1/4"	23 1/2"	STWR4615BBFR(J/B/R)	\$1,477	\$1,625	\$1,772

51" High — includes 1 adj. shelf

L	51 3/8"	15 1/4"	23 1/2"	STWR5115FFL(J/B/R)	\$1,477	\$1,625	\$1,772
R	51 3/8"	15 1/4"	23 1/2"	STWR5115FFR(J/B/R)	\$1,477	\$1,625	\$1,772
L	51 3/8"	15 1/4"	23 1/2"	STWR5115BBFL(J/B/R)	\$1,547	\$1,702	\$1,856
R	51 3/8"	15 1/4"	23 1/2"	STWR5115BBFR(J/B/R)	\$1,547	\$1,702	\$1,856

56" High — includes 1 adj. shelf

L	56"	15 1/4"	23 1/2"	STWR5615FFL(J/B/R)	\$1,477	\$1,625	\$1,772
R	56"	15 1/4"	23 1/2"	STWR5615FFR(J/B/R)	\$1,477	\$1,625	\$1,772
L	56"	15 1/4"	23 1/2"	STWR5615BBFL(J/B/R)	\$1,547	\$1,702	\$1,856
R	56"	15 1/4"	23 1/2"	STWR5615BBFR(J/B/R)	\$1,547	\$1,702	\$1,856

66" High — includes 2 adj. shelves

L	65 7/8"	15 1/4"	23 1/2"	STWR6615FFL(J/B/R)	\$1,597	\$1,757	\$1,916
R	65 7/8"	15 1/4"	23 1/2"	STWR6615FFR(J/B/R)	\$1,597	\$1,757	\$1,916
L	65 7/8"	15 1/4"	23 1/2"	STWR6615BBFL(J/B/R)	\$1,697	\$1,867	\$2,036
R	65 7/8"	15 1/4"	23 1/2"	STWR6615BBFR(J/B/R)	\$1,697	\$1,867	\$2,036

STWR	Tower	H	W	Drawers	Coat Door	Pull
		56	15	FF BBF	L Left R Right	J J Pull B Bar Pull R Radiused Pull
STWR		56	15	FF	L	J

Specify

1. Model #
2. Case finish

Pulls



B – Bar Pull



R – Radiused



J – J Pull

Application Notes

- Single lock for cupboard & drawers
- Leveling glides allow for 7/8" adjustment
- Will not accommodate worksurface support bracket



SSAT5615BBFLB

46" High — does not include an adj. shelf

OPEN	H	W	D	MODEL #	PAINT		
					P1	P2	P3
L	46"	15 1/4"	23 1/2"	SSAT4615FFL(J/B/R)	\$1,297	\$1,427	\$1,556
R	46"	15 1/4"	23 1/2"	SSAT4615FFR(J/B/R)	\$1,297	\$1,427	\$1,556
L	46"	15 1/4"	23 1/2"	SSAT4615BBFL(J/B/R)	\$1,397	\$1,537	\$1,676
R	46"	15 1/4"	23 1/2"	SSAT4615BBFR(J/B/R)	\$1,397	\$1,537	\$1,676

51" High — includes 1 adj. shelf

L	51 3/8"	15 1/4"	23 1/2"	SSAT5115FFL(J/B/R)	\$1,397	\$1,537	\$1,676
R	51 3/8"	15 1/4"	23 1/2"	SSAT5115FFR(J/B/R)	\$1,397	\$1,537	\$1,676
L	51 3/8"	15 1/4"	23 1/2"	SSAT5115BBFL(J/B/R)	\$1,497	\$1,647	\$1,796
R	51 3/8"	15 1/4"	23 1/2"	SSAT5115BBFR(J/B/R)	\$1,497	\$1,647	\$1,796

56" High — includes 1 adj. shelf

L	56"	15 1/4"	23 1/2"	SSAT5615FFL(J/B/R)	\$1,497	\$1,647	\$1,796
R	56"	15 1/4"	23 1/2"	SSAT5615FFR(J/B/R)	\$1,497	\$1,647	\$1,796
L	56"	15 1/4"	23 1/2"	SSAT5615BBFL(J/B/R)	\$1,597	\$1,757	\$1,916
R	56"	15 1/4"	23 1/2"	SSAT5615BBFR(J/B/R)	\$1,597	\$1,757	\$1,916

66" High — includes 2 adj. shelves

L	65 7/8"	15 1/4"	23 1/2"	SSAT6515FFL(J/B/R)	\$1,547	\$1,702	\$1,856
R	65 7/8"	15 1/4"	23 1/2"	SSAT6515FFR(J/B/R)	\$1,547	\$1,702	\$1,856
L	65 7/8"	15 1/4"	23 1/2"	SSAT6515BBFL(J/B/R)	\$1,647	\$1,812	\$1,976
R	65 7/8"	15 1/4"	23 1/2"	SSAT6515BBFR(J/B/R)	\$1,647	\$1,812	\$1,976

WORKSURFACES & 15" TOWERS



When adding a 15" tower to the end of a work surface you will need to add a "T" to the end of the model number in order to make the work surface and tower completely flush. This will only be necessary on 24" deep work surfaces with a width from 48" – 84".

	H	W	Drawers	Coat Door	Pull
SSAT Side Access Tower	56	15	FF BBF	L Left R Right	J J Pull B Bar Pull R Radiused Pull
SSAT	56	15	FF	L	J

Specify

1. Model #
2. Case finish

Pulls



B – Bar Pull



J – J Pull



R – Radiused

Application Notes

- Single lock for all drawers
- Leveling glides allow for 1 5/8" adjustment

Credenzas

General Info

Step 1 – Model

SCR Credenza	Shelf Width	S Shelf	Drawer Width	D Drawer	Top	Pull
SCR	30	S	20	D	MT Metal Top NT No Top	J J Pull B Bar Pull
SCR	30	S	20	D	MT	J

Step 2 – Case Finish

Paints
301 Champagne
301

Step 3 – Front Finish

Not Available w/J Pull	
Laminate	
PW-STK	Studio Teak
PW-STK	

FEATURES

COUNTERWEIGHT

- Two drawer cabinets include factory installed counterweights
- Low storage cabinets that do not include shelves do not need counterweight

LOCK

- Available on credenza products which feature drawers
- Lock core is removable
- Keyed alike available upon request
- Master and change key available upon request

DRAWERS

- Include full suspension steel ball-bearing slides
- Drawer fronts include rubber bumpers for quiet operation

SHELF

¾" High adjustable shelf

LEVELING GLIDES

4 Leveling glides allow for ½" adjustment

TOP

Available in metal, cushion and laminate

CONSTRUCTION

OUTER SHELL & DRAWER CONSTRUCTION

Welded steel frame construction & formed channels ensure strength in key areas.

Bottom channels	16 gauge
Top channels	18 gauge
Shelves	18 gauge
Side channels	20 gauge
Side panels	20 gauge
Top	20 gauge
Fronts	20 gauge
Drawer bins	22 gauge

DRAWER INNER DIMENSIONS

Height

6" Drawer	4 ½"
12" Drawer	10 ¾"

Width

30" Wide drawer	12 ⅛"
36" Wide drawer	32 ⅞"
42" Wide drawer	38 ⅞"

Depth

All drawers	15 ⅞"
-------------	-------

SHELF INNER DIMENSIONS

Height

All shelves	16 ⅞"
-------------	-------

Width

30" Wide drawer	28 ½"
36" Wide drawer	34 ½"
42" Wide drawer	40 ½"

Depth

All drawers	19"
-------------	-----

PULL STYLES

Available with Laminate Front



B – Bar Pull



J – J Pull

SURFACE MATERIALS

CASE

Paint

FRONTS

w/Bar pull (B)	Paint or Laminate
w/J pull (J)	Paint

DRAWER PULL

Bar (B)	Satin nickel
J (J)	Paint

LOCK

Satin Nickel

CUSHION TOP

Upholstery

CREDENZAS

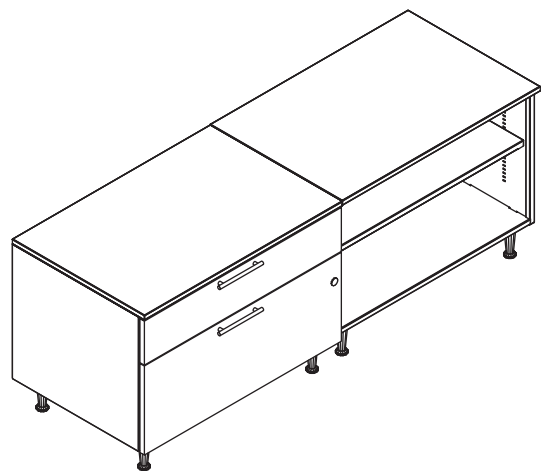

Storage

Credenzas

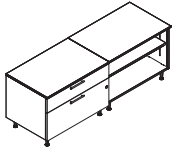

Credenzas

DESCRIPTION	H	W	D	MODEL #
30" Drawers, 30" open shelf	22 1/4"	60"	20"	SCR30D30S(J/B)
30" Drawers, 36" open shelf	22 1/4"	66"	20"	SCR30D36S(J/B)
36" Drawers, 36" open shelf	22 1/4"	72"	20"	SCR36D36S(J/B)

PAINT			LAMINATE FRONT (UPCHARGE)		
P1	P2	P3	L1	L2	L3
\$2,377	\$2,615	\$2,852	+\$1,300	+\$1,430	+\$1,560
\$2,447	\$2,692	\$2,936	+\$1,300	+\$1,430	+\$1,560
\$2,577	\$2,835	\$3,092	+\$1,400	+\$1,540	+\$1,680

Credenza – Cushion Tops

DESCRIPTION	H	W	D	MODEL #	BLACK
20"D x 12"W Cushion	1"	12"	20"	SCRC2012	\$207
20"D x 18"W Cushion	1"	18"	20"	SCRC2018	\$247
20"D x 30"W Cushion	1"	30"	20"	SCRC2030	\$327
20"D x 36"W Cushion	1"	36"	20"	SCRC2036	\$397
20"D x 42"W Cushion	1"	42"	20"	SCRC2042	\$437
20"D x 60"W Cushion	1"	60"	20"	SCRC2060	\$527
20"D x 66"W Cushion	1"	66"	20"	SCRC2066	\$567
20"D x 72"W Cushion	1"	72"	20"	SCRC2072	\$597

Credenza Cushion Fabric Upcharges

SEATING GRADES	SYSTEM GRADES	UPCHARGE
C	A	+\$225
1	B	+\$300
2	C	+\$400
3	D	+\$500
4	E	+\$600
5	F	+\$700
6	G	+\$800
	H	+\$900

Credenza – Accessories

DESCRIPTION	H	W	D	MODEL #	PAINT		
					P1	P2	P3
Floating top supports, 2 legs	5 1/2"	2 1/2"	1 1/8"	SCRSL2	\$247	\$272	\$296
Credenza center leg support				SCRCLS	\$197	\$217	\$236
Credenza ganging kit				SCRGK	\$147	\$162	\$176

		Shelf Width		Drawer Width			Top		Pull	
SCR	Credenza	30	S Shelf	20	D	Drawer	MT NT	Metal Top No Top	J B	J Pull Bar Pull
SCR		30	S	20	D		MT		J	

Specify

1. Model #
2. Case finish
3. Front finish
Laminate not available on J pull

Pulls

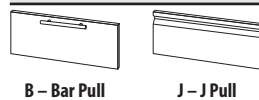

B – Bar Pull

J – J Pull

Application Notes

- Credenzas must be assembled in the field
- Cabinets are unhandled
- Shelf units include 1 adjustable shelf
- When ganging 2 units together, order ganging kit
- Leveling glides allow for 1 3/8" adjustment
- Drawer units include 1 – 6" drawer & 1 – 12" file drawer & counterweight

Credenza Includes

- 2 low storage cabinets
- 1 top & ganging kit
- 1 credenza center support leg



Credenza – Drawers

DESCRIPTION	H	W	D	MODEL #	PAINT			LAMINATE FRONT (UPCHARGE)		
					P1	P2	P3	L1	L2	L3
30" Drawers, metal top	22 1/4"	30"	20"	SCRD3020MT(J/B)	\$1,147	\$1,262	\$1,376	+ \$530	+ \$583	+ \$636
36" Drawers, metal top	22 1/4"	36"	20"	SCRD3620MT(J/B)	\$1,197	\$1,317	\$1,436	+ \$550	+ \$605	+ \$660
42" Drawers, metal top	22 1/4"	42"	20"	SCRD4220MT(J/B)	\$1,297	\$1,427	\$1,556	+ \$590	+ \$649	+ \$708
30" Drawers, no top	22 1/4"	30"	20"	SCRD3020NT(J/B)	\$1,107	\$1,218	\$1,328	+ \$530	+ \$583	+ \$636
36" Drawers, no top	22 1/4"	36"	20"	SCRD3620NT(J/B)	\$1,157	\$1,273	\$1,388	+ \$550	+ \$605	+ \$660
42" Drawers, no top	22 1/4"	42"	20"	SCRD4220NT(J/B)	\$1,257	\$1,383	\$1,508	+ \$590	+ \$649	+ \$708



Credenza – Shelves

DESCRIPTION	H	W	D	MODEL #	P1	P2	P3	L1	L2	L3
30" Shelf, metal top	22 1/4"	30"	20"	SCRS3020MT	\$917	\$1,009	\$1,100	N/A	N/A	N/A
36" Shelf, metal top	22 1/4"	36"	20"	SCRS3620MT	\$977	\$1,075	\$1,172	N/A	N/A	N/A
42" Shelf, metal top	22 1/4"	42"	20"	SCRS4220MT	\$1,057	\$1,163	\$1,268	N/A	N/A	N/A
30" Shelf, no top	22 1/4"	30"	20"	SCRS3020NT	\$897	\$987	\$1,076	N/A	N/A	N/A
36" Shelf, no top	22 1/4"	36"	20"	SCRS3620NT	\$947	\$1,042	\$1,136	N/A	N/A	N/A
42" Shelf, no top	22 1/4"	42"	20"	SCRS4220NT	\$997	\$1,097	\$1,196	N/A	N/A	N/A

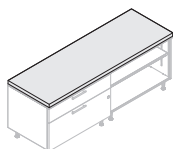

Credenza – Common Tops

DESCRIPTION	H	W	D	MODEL #	LAMINATE		
					L1	L2	L3
Single 30" W credenza top	5/8"	30"	20"	CT30	\$365	\$402	\$438
Single 36" W credenza top	5/8"	36"	20"	CT36	\$390	\$429	\$468
Single 42" W credenza top	5/8"	42"	20"	CT42	\$420	\$462	\$504
Double 30" W credenza top	5/8"	60"	20"	CT60	\$475	\$523	\$570
Double 30"/36" W credenza top	5/8"	66"	20"	CT66	\$500	\$550	\$600
Double 36" W credenza top OR 30"/42" W credenza top	5/8"	72"	20"	CT72	\$510	\$561	\$612
Double 36"/42" W credenza top	5/8"	78"	20"	CT78	\$530	\$583	\$636
Double 42" W credenza top	5/8"	84"	20"	CT84	\$560	\$616	\$672

	H	W	Drawers	Pull
SCRD Credenza – Drawer	30	20	MT Metal Top	J J Pull
SCRS Credenza – Shelves			NT No Top	B Bar Pull
SCRD	30	20	MT	J

Specify

- Model #
- Case finish
- Front finish
Laminate not available on J pull

Pulls

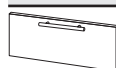

B – Bar Pull



J – J Pull

Application Notes

- Center leg helps to gang 2 credenza pieces together side by side
- Ganging kit for use when specifying laminate top separately, does not include center leg
- Floating top supports may not be used on a metal top, includes top mounting bracket, screws & drill plate

Cabinets

Step 1 – Model

	H	W	D	Pull
SCAB Cabinet	77	30	18	J J Pull B Bar Pull
SCAB	77	30	18	J

Step 2 – Case Finish

Paint
301 Champagne
301

FEATURES

LOCK

- Lock core is removable
- Keyed alike available upon request
- Master and change key available upon request

DOORS

- Concealed hinges allow for 110° degrees opening

LEVELING GLIDES

4 Leveling glides allow for ¼" adjustment

CONSTRUCTION

OUTER SHELL & DRAWER CONSTRUCTION

Welded steel frame construction & formed channels ensure strength in key areas.

Back panel	20 – 22 gauge
Side panels	20 – 22 gauge
Inner channels	18 gauge
Top	18 gauge
Doors	18 gauge

SHELF LOAD CAPACITY

Shelf	140 lbs
-------	---------

TOP LOAD CAPACITY

30" Wide cabinets	140 lbs
36" Wide cabinets	169 lbs
42" Wide cabinets	197 lbs

INNER DIMENSIONS

Height

2 High	72 ½"
3 High	61"
4 High	46 ½"
5 High	35"
6 High	23 ½"

Width

30" Wide cabinets	26 ¾"
36" Wide cabinets	32 ¾"
42" Wide cabinets	38 ¾"

Depth

All cabinets	17 ¾"
--------------	-------

PULL STYLES



B – Bar Pull



J – J Pull

SURFACE MATERIALS

CASE

Paint

FRONTS

w/Bar Pull (B)	Paint
w/J Pull (J)	Paint

DRAWER PULL

Bar (B)	Satin nickel
J (J)	Paint

LOCK

Satin nickel

CABINETS

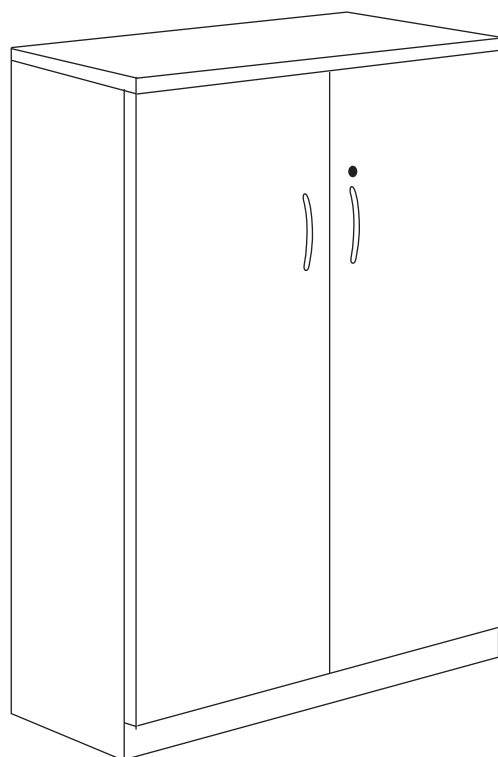

Storage

Cabinets



2 High

H	W	D	MODEL #	PAINT		
				P1	P2	P3
28 3/8"	30"	18 1/4"	SCAB293018(J/B)	\$997	\$1,097	\$1,196
28 3/8"	36"	18 1/4"	SCAB293618(J/B)	\$1,097	\$1,207	\$1,316
28 3/8"	42"	18 1/4"	SCAB294218(J/B)	\$1,197	\$1,317	\$1,436



3 High

39 7/8"	30"	18 1/4"	SCAB403018(J/B)	\$1,197	\$1,317	\$1,436
39 7/8"	36"	18 1/4"	SCAB403618(J/B)	\$1,297	\$1,427	\$1,556
39 7/8"	42"	18 1/4"	SCAB404218(J/B)	\$1,397	\$1,537	\$1,676

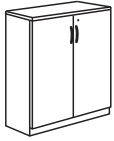

4 High

51 3/8"	30"	18 1/4"	SCAB523018(J/B)	\$1,447	\$1,592	\$1,736
51 3/8"	36"	18 1/4"	SCAB523618(J/B)	\$1,547	\$1,702	\$1,856
51 3/8"	42"	18 1/4"	SCAB524218(J/B)	\$1,647	\$1,812	\$1,976

Specify

1. Model #
2. Case finish

Application Notes

- Leveling glides allow for 1/4" adjustment
- Shelf load capacity is 140 lbs
- Inside depth is 17 3/16" and 18 1/2" deep units
- Top weight capacity 30" – 140 lbs
36" – 168 lbs
42" – 197 lbs

		H	W	D	Pull
SCAB	Cabinet	77	30	18	J J Pull B Bar Pull
SCAB		77	30	18	J

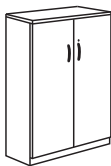

5 High

H	W	D	MODEL #	PAINT		
				P1	P2	P3
65 7/8"	30"	18 1/4"	SCAB663018(J/B)	\$1,647	\$1,812	\$1,976
65 7/8"	36"	18 1/4"	SCAB663618(J/B)	\$1,747	\$1,922	\$2,096
65 7/8"	36"	23 1/2"	SCAB663624(J/B)	\$2,147	\$2,362	\$2,576
65 7/8"	42"	18 1/4"	SCAB664218(J/B)	\$1,847	\$2,032	\$2,216

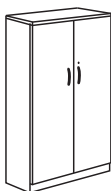

6 High

77 3/8"	30"	18 1/4"	SCAB773018(J/B)	\$1,897	\$2,087	\$2,276
77 3/8"	36"	18 1/4"	SCAB773618(J/B)	\$1,997	\$2,197	\$2,396
77 3/8"	36"	23 1/2"	SCAB773624(J/B)	\$2,247	\$2,472	\$2,696
77 3/8"	42"	18 1/4"	SCAB774318(J/B)	\$2,097	\$2,307	\$2,516

Specify

1. Model #
2. Case finish

Application Notes

- Leveling glides allow for 1/4" adjustment
- Shelf load capacity is 140 lbs
- Inside depth is 17 3/16" and 18 1/2" deep units
- Top weight capacity 30" – 140 lbs
36" – 168 lbs
42" – 197 lbs

SCAB	Cabinet	H	W	D	Pull
		77	30	18	J J Pull B Bar Pull
SCAB		77	30	18	J

Lockers

Step 1 – Model

		H	D	Hinge	Pull
SLKR	Locker	51	18	L R	J B J Pull Bar Pull
SLKR		51	18	L	J

Step 2 – Case Finish

Paint
301 Champagne
301

FEATURES

LOCK

- Lock core is removable
- Keyed alike available upon request
- Master and change key available upon request

BODY

- Available in 2 depths: 18 ¼" and 23 ½"

DOORS

- All lockers come standard with metal doors
- Concealed hinges allow for 100 degree opening

SHELF

- Includes one fixed shelf on top w/ 12" clear height above
- Additional shelves may be ordered separately. Contact Sales Support for additional information and pricing

COAT ROD

Includes side-to-side coat rod beneath shelf

LEVELING GLIDES

- 4 leveling glides allow for 7/8" adjustment
- Glides are accessible from the inside of the locker

CONSTRUCTION

OUTER SHELL & DRAWER CONSTRUCTION

Welded steel frame construction & formed channels ensure strength in key areas.

Top panel	21 gauge
Side panels	21 gauge
Back panel	21 gauge
Center panel	21 gauge
Inner top channel	18 gauge
Inner bottom channel	18 gauge
Inner side channels	18 gauge
Bottom pad	16 gauge
Door fronts	20 – 22 gauge
Shelves	18 gauge

DRAWER INNER DIMENSIONS

Height

Above shelf	12"
Below coat rod – 51" High	31 7/10"
Below coat rod – 66" High	46 1/5"

Width

All lockers	9 4/5"
-------------	--------

Depth

18 ½" Deep locker	17 3/5"
23 ½" Deep locker	22 3/5"

PULL STYLES



B – Bar Pull



J – J Pull

SURFACE MATERIALS

LOCKER

Paint

DRAWER PULL

Bar (B)

J (J)

Satin nickel

Paint

LOCK

Satin nickel

LOCKERS

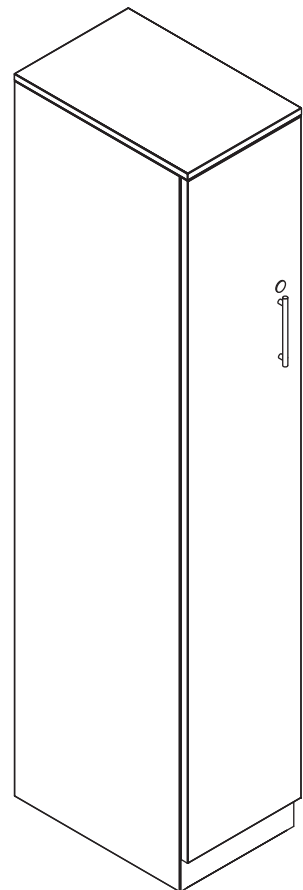

Lockers

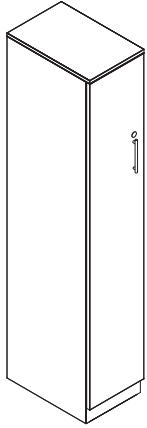

51" High

HINGE	H	W	D	MODEL #	PAINT		
					P1	P2	P3
L	51 3/8"	12"	18 1/4"	SLKR5118L(J/B)	\$1,397	\$1,537	\$1,676
R	51 3/8"	12"	18 1/4"	SLKR5118R(J/B)	\$1,397	\$1,537	\$1,676
L	51 3/8"	12"	23 1/2"	SLKR5124L(J/B)	\$1,427	\$1,570	\$1,712
R	51 3/8"	12"	23 1/2"	SLKR5124R(J/B)	\$1,427	\$1,570	\$1,712

Specify

1. Model #
2. Case finish

Application Notes

- Includes 1 fixed shelf on top with 12" clear height above
- Side to side coat rod under shelf
- Leveling glides allow for 7/8" adjustment

		H	D	Hinge	Pull
SLKR	Locker	51	18	L R	J J Pull B Bar Pull
SLKR		51	18	L	J

66" High

HINGE	H	W	D	MODEL #	PAINT		
					P1	P2	P3
L	65 7/8"	12"	18 1/4"	SLKR6618L(J/B)	\$1,477	\$1,625	\$1,772
R	65 7/8"	12"	18 1/4"	SLKR6618R(J/B)	\$1,477	\$1,625	\$1,772
L	65 7/8"	12"	23 1/2"	SLKR6624L(J/B)	\$1,527	\$1,680	\$1,832
R	65 7/8"	12"	23 1/2"	SLKR6624R(J/B)	\$1,527	\$1,680	\$1,832

Specify

1. Model #
2. Case finish

Application Notes

- Includes 1 fixed shelf on top with 12" clear height above
- Side to side coat rod under shelf
- Leveling glides allow for 7/8" adjustment

		H	D	Hinge	Pull
SLKR	Locker	51	18	L R	J J Pull B Bar Pull
SLKR		51	18	L	J

Bookcases

Step 1 – Model

	H	W
SBC Bookcases	66	42
SBC	66	42

Step 2 – Case Finish

Paint
301 Champagne
301

FEATURES

SHELVES

- 1" thick
- Adjustable in ½" increments
- 2-high bookcases will accommodate binder-height storage on both shelves
- All other bookcases, binder-height storage is available on all but 1 shelf

LEVELING GLIDES

4 Leveling glides allow for 1 ⅝" adjustment.

SAFETY:

- To ensure stability, do not install a 4, 5, or 6 high bookcase in the center of a room
- Bookcases should be installed back-to-back or against a wall.

NOTE

- 2-high bookcases are slightly shorter than 2-high lateral files and double door storage cabinets
- 2-high bookcases are designed to fit under a worksurface

CONSTRUCTION

OUTER SHELL & DRAWER CONSTRUCTION

Welded steel frame construction & formed channels ensure strength in key areas.

Side channels	22 gauge
Side panels	22 gauge
Bottom panel	18 gauge
Shelves	18 gauge

SHELF LOAD CAPACITY

All bookcases	140 lbs
---------------	---------

INNER DIMENSIONS

Height

2 High	25 ½"
3 High	37 ¾"
4 High	48 ½"
5 High	63 ¾"
6 High	74 ½"

Width

30" Wide bookcases	27 7/10"
36" Wide bookcases	33 7/10"
42" Wide bookcases	39 7/10"

Depth

All cabinets	13 1/10"
--------------	----------

SURFACE MATERIALS

CASE

Paint

TOP

Paint

BOOKCASES

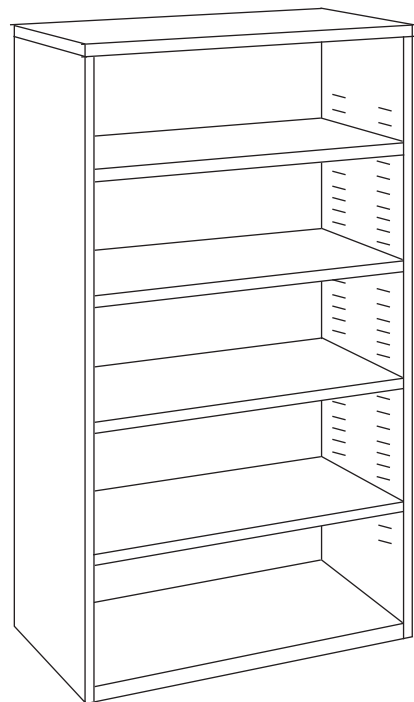

Storage

Bookcases



2 High

H	W	D	MODEL #	PAINT		
				P1	P2	P3
27 ¾"	30"	13 ⅜"	SBC2830	\$827	\$910	\$992
27 ¾"	36"	13 ⅜"	SBC2836	\$877	\$965	\$1,052
27 ¾"	42"	13 ⅜"	SBC2842	\$977	\$1,075	\$1,172



3 High

39 ⅞"	30"	13 ⅜"	SBC4030	\$897	\$987	\$1,076
39 ⅞"	36"	13 ⅜"	SBC4036	\$977	\$1,075	\$1,172
39 ⅞"	42"	13 ⅜"	SBC4042	\$1,077	\$1,185	\$1,292



4 High

51 ⅞"	30"	13 ⅜"	SBC5230	\$997	\$1,097	\$1,196
51 ⅞"	36"	13 ⅜"	SBC5236	\$1,077	\$1,185	\$1,292
51 ⅞"	42"	13 ⅜"	SBC5242	\$1,177	\$1,295	\$1,412

Specify

1. Model #
2. Case finish

Application Notes

- Steel frame construction
- Double wall construction on side panels
- Leveling glides allow for ⅝" adjustment
- Shelves adjust in ½" increments
- Bookcases should be installed with back against a wall.
- Shelf capacity 140 lbs
- 2 high bookcase is slightly shorter than 2 door cabinet as it is designed to fit under a worksurface

		H	W
SBC	Bookcases	66	42
SBC		66	42



5 High

H	W	D	MODEL #	PAINT		
				P1	P2	P3
65 7/8"	30"	13 3/8"	SBC6630	\$1,097	\$1,207	\$1,316
65 7/8"	36"	13 3/8"	SBC6636	\$1,177	\$1,295	\$1,412
65 7/8"	42"	13 3/8"	SBC6642	\$1,277	\$1,405	\$1,532



6 High

77 3/8"	30"	13 3/8"	SBC7730	\$1,197	\$1,317	\$1,436
77 3/8"	36"	13 3/8"	SBC7736	\$1,277	\$1,405	\$1,532
77 3/8"	42"	13 3/8"	SBC7742	\$1,377	\$1,515	\$1,652

Specify

1. Model #
2. Case finish

Application Notes

- Steel frame construction
- Double wall construction on side panels
- Leveling glides allow for 5/8" adjustment
- Shelves adjust in 1/2" increments
- Bookcases should be installed with back against a wall.
- Shelf capacity 140 lbs
- 2 high bookcase is slightly shorter than 2 door cabinet as it is designed to fit under a worksurface

		H	W
SBC	Bookcases	66	42
SBC		66	42

WORKPLACE ACCESSORIES

Neutral Posture is proud to offer the complete package for commercial office furniture. Workplace accessories round out our offering and allow users to truly customize their space to be as comfortable and as ergonomic as possible.

CUSTOMIZE YOUR SPACE WITH:

- Keyboard mechanisms
- Keyboard trays
- Monitor arms
- Footrests
- Tablet holders
- CPU holders
- Forearm supports
- Patented ergonomic products

WORKPLACE ACCESSORIES

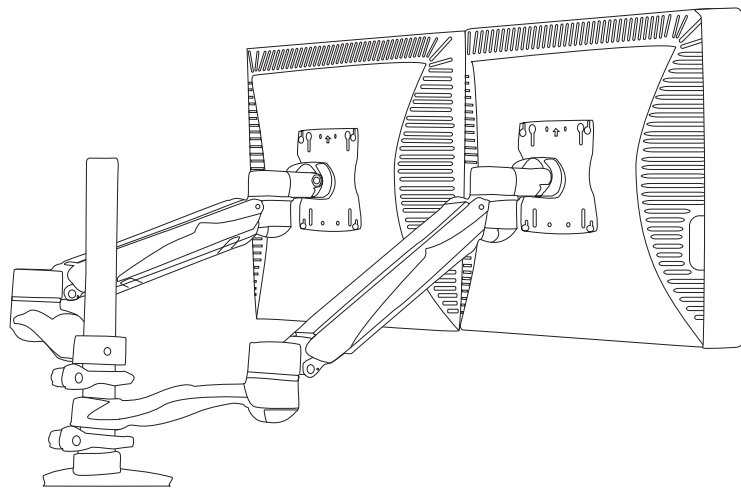

Keyboard Trays & Arms

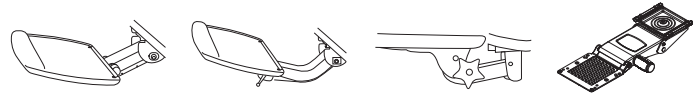

Leverless

Sit/Stand

Econo

Dual Indicator

HFES compliant

	A	C	E	U
Code	A	C	E	U
Leverless Height	✓	✓	NA	NA
Height	-6" – 2.5"	-6" – 8"	-5.25" – 0"	-6.5" – 2.38"
Tilt	-15° – 0°	-15° – 0°	-15° – 15°	-20° – 10°
Spring Assist	✓	✓	✓	✓
360° Rear Swivel	✓	✓	✓	✓
Track Length	23"	21"	18"	19"
Short Track (Options)	18"	18"	NA	NA
Glide Track	✓	✓	✓	✓
List	\$210	\$230	\$160	\$245

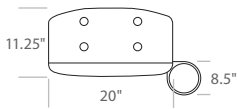

11

- Straights, corners & natural keyboards
- Anti-skid neoprene pads hold keyboard securely in place

\$155

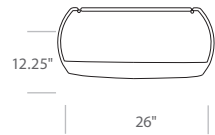

43 — SofTouch™

- Straight
- Urethane over steel plate
- Includes mouse surface

\$230

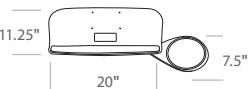

86 — elementAl®



- Straights, corners and natural keyboards
- Made from strong 100% recycled aluminum
- Polished surface

\$295

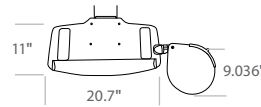

52



- Straight
- 20" "green" tray
- Height adjustable tilt & swivel mouse
- Gel filled palm rest

\$325

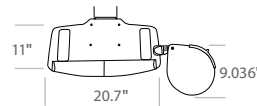

21

- Straight
- 20" phenolic tray
- Height adjustable tilt & swivel mouse
- Gel filled palm rest

\$325

EASY COMBOS

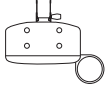
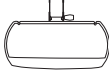
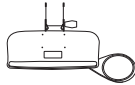
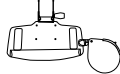
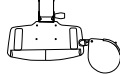
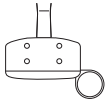
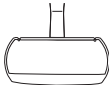
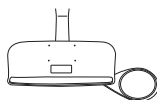
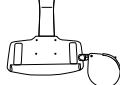
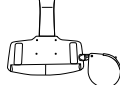
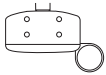
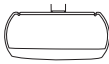
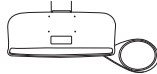
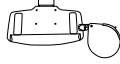
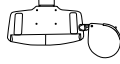
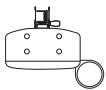
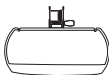
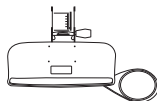
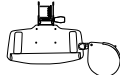
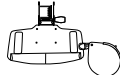
11	43 - SofTouch™	86 - elementAI®	52	21	
					Leverless (A)
Easy A11 \$365	Easy A43 \$440	Easy A86 \$505	Easy A52 \$535	Easy A21 \$535	
					Sit/Stand (C)
Easy C11 \$385	Easy C43 \$460	Easy C86 \$525	Easy C52 \$555	Easy C21 \$555	
					Econo (E)
Easy E11 \$315	Easy E43 \$390	Easy E86 \$455	Easy E52 \$485	Easy E21 \$485	
					Dual Indicator (U)
Easy U11 \$400	Easy U43 \$475	Easy U86 \$540	Easy U52 \$570	Easy U21 \$570	

Monitor Arms

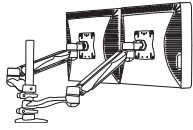

MONITOR ARMS

BOOST™ MONITOR ARM

- Yields 13" of vertical movement & 24" of extension
- Supports monitors weighing up to 20 lbs
- Effortlessly position two monitors at the same height on a single post
- Easily attach two arms on a single post without additional brackets
- Install three or more arms with an optional cross bar
- Convenient keyhole slots to effortlessly install monitor onto mounting plate
- Panel, slat wall & desk mounting options

NOTE: For multi-screen solutions, contact cs@np-us.com

Single Arm		List
KCG-110B	Black	\$455
KCG-110S	Silver	\$455
Double Arm		List
KCG-110DB	Black	\$899
KCG-110DS	Silver	\$899
Wall Mount		List
KCG-WMB	Black	\$525
KCG-WMS	Silver	\$525

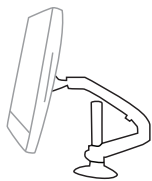

FREEDOM ARM

- Includes: vesa plate aluminum articulating arm & desk clamp base
- Tilt: Up 90°, Down 45°
- Pan: 180°
- Rotation: 360°
- Offers 14" of dynamic one-touch height adjustment
- Full extension range of 23.4"

Model #		List
918001	Silver	\$495

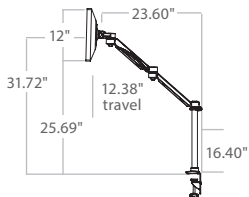

SIT/STAND MONITOR ARM

- Sturdy aluminum construction with vesa compatibility
- Width & depth adjustable fasteners
- Convenient pull handle

Model #		List
KCG-SSB	Black	\$575
KCG-SSS	Silver	\$575

MONITOR ARM ATTACHMENTS

DOCUMENT HOLDER (ATTACHMENT ONLY)

- Ergonomically correct viewing position of documents for computer users
- Easy adjustment to ensure a comfortable viewing angle
- Helps keep work surface clear
- Stores out of the way when not in use

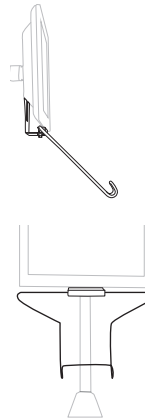

Model #		List
160236	Black	\$185
160237	Silver	\$185

CPU HOLDERS

CPU HOLDER

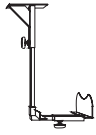

- Mounts easily under work surface storing CPU safely under desk & off the floor
- Adjusts to either a vertical or horizontal position
- Adjustable width of 5.5" – 9.8" & height of 15.5" – 20"

Model # **List**
VCPUF \$175

CPU HOLDER W/STRAP

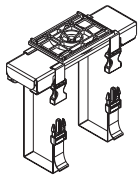

- CPU retracts on a 17" track & swivels to allow full accessibility & easy storage
- Accommodates CPU weighing up to 75 lbs & measuring 64" in perimeter
- Installation is quick & easy as straps adjust & fasten with buckles
- Soft touch anti-slip pads

Model # **List**
VCPU \$195

TABLET HOLDER

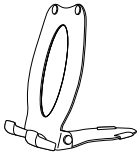

- Weight: 12 oz
- Dimensions: 6.76 x 5.5 x 2
- Holds tablets, phones or documents upright
- Easily adjusts for comfortable viewing angle
- Rests on desktop or flat surfaces

Model # **List**
TABHLDR \$137

ACCESSORIES

STANDUP®



- Retrofits between most existing keyboard trays & keyboard arms
- Mounts directly to work surface without keyboard arm
- Additional 2" – 11" of height adjustment
- Infinite range positioning
- \$50 discount when ordered with any Easy Combo (page 133)

Model # **List**
SUP04 \$420

FOREARM SUPPORTS

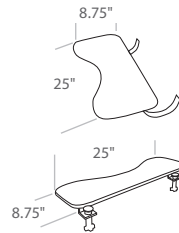

- Alleviates shoulder, neck & body burden
- Promotes good posture & ergonomic sitting
- Lightweight & portable



Model 1	Model 2	
160241 \$240	160243 \$240	w/Hooks
160242 \$240	160244 \$240	w/Screws

ANTI-FATIGUE FLOOR MATS

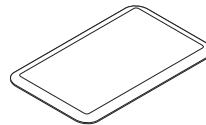

- Premium comfort will not bottom out or lose bounce over time
- Commercial-grade heavy-duty polyurethane
- Matt texture provides optimum traction
- Beveled edge reduces tripping potential
- Black only

H	W	D	MODEL #	LIST
¾"	32"	20"	EAM3220B	\$285
¾"	48"	20"	EAM4820B	\$435
¾"	72"	20"	EAM7220B	\$648
¾"	36"	24"	EAM3624B	\$360
¾"	60"	36"	EAM6036B	\$828



NeutralPosture

ISO 9001:2008 Approved NeutralPosture.com

Made in the U.S.A. 3904 N. Texas Ave.

Bryan, TX 77803



WOMEN
OWNED

T 979.778.0502

F 979.778.0408